

MIRKA

Pneumatic and Electric Mobile Dust-Free Sanding Solutions



Timo Korpinen, Toyota Kaivoksela

Mobile Systems

How much time in your shop is lost each day?

The old adage "time is money" has never been more important. Now, the definition has been narrowly focused as "cycle time", which is the amount of time required to complete a process. The reduction of cycle times is critical to improving the bottom line in professional autobody repair. By utilizing a mobile workstation that can keep all of the required materials within ten feet of the repair, a technician can eliminate the wasted trips in the repair bay that increase the duration of the repair process.

The Mirka Smart Cart is the perfect solution to keep all your abrasives, tools, and dust extractor at one place as an integrated, dust-free sanding system.

- Movable platform for the DE-1230-PC dust extractor
- Integrated storage hooks for vacuum hoses
- Locking cabinet for inventory control
- 17-3/4" x 27" work surface, recessed 2"
- Two (2) 15-3/4" x 12" x 2-3/4" drawers
- Dedicated tool rests are located on a wire rack
- Manifold with auxiliary air fitting (pneumatic)
- Integrated storage for polish bottles or aerosol cans
- Premium casters incorporating a foot pedal wheel brake
- Swivel locks to prevent movement of the cart



The Mirka Trolley was specifically designed for small or tight spaces and is the perfect solution for keeping all your abrasives, tools, and dust extractor in one place as an integrated, dust-free sanding system.

- Larger back wheels keep the trolley stable
- Bottom shelf for the DE-1230-PC dust extractor
- Upper shelf for abrasives, polishes and other components
- Several hooks for tools keep you organized
- Manifold with auxiliary air fitting (pneumatic)
- Larger height adjustable hook
- Dedicated vacuum hose hook
- Velcro strip for hand blocks
- Swivel locks on wheels

Dust-Free Sanding Perfection

We are all looking for ways to become more profitable and efficient in our collision repair operations. The on-going dynamics in the collision industry today have forced us to evaluate every facet of operations.

Mirka's Optimized Surface Preparation (OSP) System provides a unique, four-step process with standardized abrasives to ensure a uniform repair process, while Autonet® offers the traditional grits utilized in the collision repair industry,

Experience NET abrasives

Fast, efficient, and standard repair process

- Less time required for the repair area
- Improved consistency and less re-work
- More repairs, more profit



Elimination of Dust in Sanding Operations

- Improved shop environment
- Less technician exposure to dust
- Reduced labor cost of clean-up and maintenance

Why Optimized Surface Preparation (OSP)?

- Easy for all operators to use and understand
- Combines three industry SOPs in one process
- Simple to standardize across all facilities
- Reduction in SKUs
- Combine OSP abrasives with Mirka's sanding tools, dust extractor and solution cart for a complete dust-free sanding system



Why Autonet®?

- Available in standard grits from P80 through P800
- Individual grit sequences can be chosen for customized SOPs
- Autonet provides unequalled dust extraction compared to conventional abrasives
- Combine NET abrasives with Mirka's sanding tools, dust extractor and solution cart for a complete dust-free sanding system

Mobile Repair Systems

Mirka's mobile repair systems are the perfect solution to keep all your abrasives, tools, and dust extraction at one place as an integrated, dust-free sanding system.

Pneumatic and Electric systems are available

But there's more required than just bringing materials closer to the work. It's equally or more important to be organized. Both the Smart Cart and Trolley provide a movable platform for the DE-1230 dust extractor with integrated storage hooks for vacuum hoses. Dedicated tool rests are designed to securely hold random orbital sanders and vacuum sanding blocks while stable, integrated storage for polish bottles or aerosol cans is provided within the full-width handle assembly. Premium casters incorporating a foot pedal wheel brake and swivel lock can be used to prevent any movement of the systems when located in a stable position.

Mirka's Body Repair Systems:

Provide an unequalled mobile solution for efficient and profitable body repair with pneumatic sanders. Available with either Autonet® or OSP (Optimized Surface Preparation) net abrasives, these systems offer dust-free sanding and superior performance. Abrasives are provided in grits **to complete all repairs in preparation for applying primer.**



Mirka's Paint Prep Systems:

Expand on our mobile body repair solution by incorporating the abrasives and tools needed **for primer application and topcoat prep and blend** with Mirka pneumatic or electric sanders. Shops can choose either Autonet® or OSP (Optimized Surface Preparation) net abrasives to achieve dust-free sanding and superior performance.

Choosing Your Dust-Free Mobile Solution

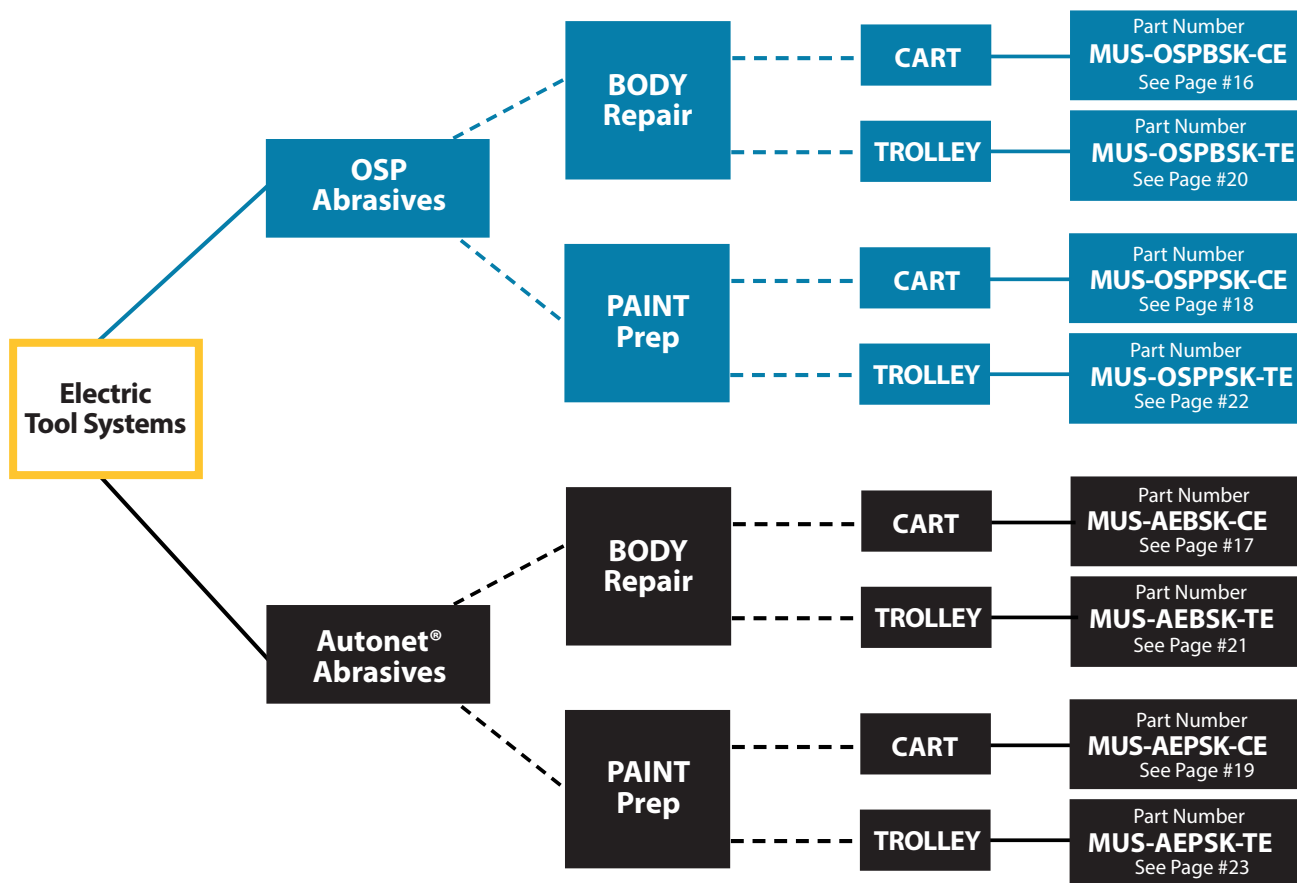
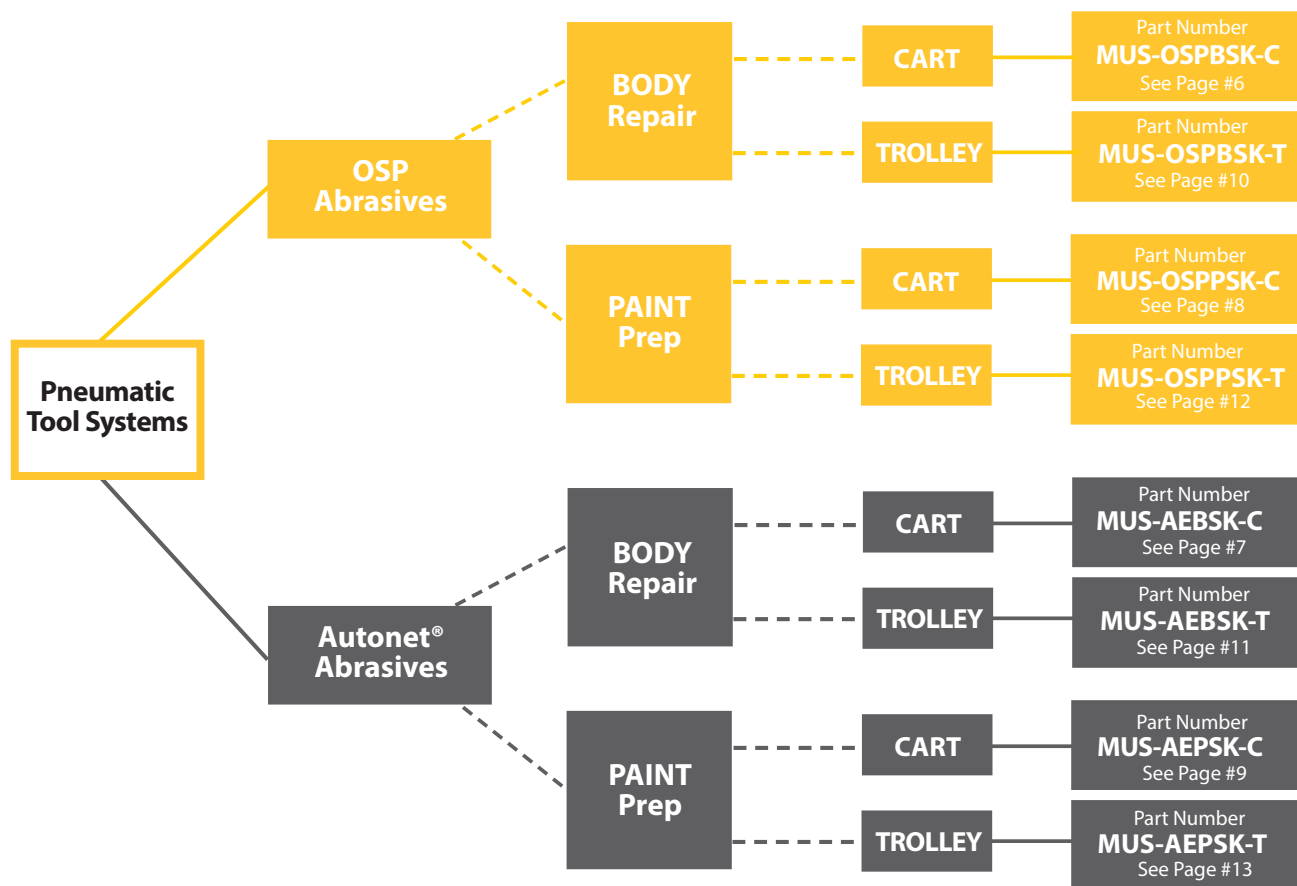





Part Number
MUS-OSPBSK-C

Smart Cart - OSP





Body Repair - Pneumatic











Abrasives Included:

Part Number	QTY	Description	Part Number	QTY	Description
OS-241-001 	1	OSP-1 Paint Removal 6" Disc	OS-241-002 	1	OSP-2 Feather Edge 6" Disc
OS-570-001 	1	OSP-1 Body Filler Roll 2-3/4" x 33'	OS-570-002 	1	OSP-2 Body Filler Roll 2-3/4" x 33'
9193500111 	1	Dry Guide Coat - Black			

Tools Included:

Part Number	QTY	Description	Part Number	QTY	Description
MRP-680CV 	1	6" Vacuum-Ready Finishing Sander (8mm orbit)	MVHB35 	1	Grip Faced Multi-Hole Vacuum Block 2-3/4" x 5"
MR-38CV-1 	1	2-3/4" x 7-3/4" Vacuum-Ready Orbital Sander (3mm orbit)	MVHB38-K 	1	Grip Faced Multi-Hole Vacuum Block Contour Kit 2-3/4" x 7-1/2"
			9116R 	1	Rigid Grip Faced Multi-Hole Vacuum Block 2-3/4" x 16-1/2"

Cart, Dust Extractor and Accessories Included:





Part Number	QTY	Description	Part Number	QTY	Description
MAI-CART-912 	1	Smart Cart for Dust-Free Sanding	91100-A 	1	3/4" x 12' Vacuum Hose for Vacuum Hand Blocks
DE-1230-PC 	1	30 Liter Portable Dust Extractor with HEPA Filter	MAI-CART-AUXAIR 	1	Manifold and 36" auxiliary air line assembly mounted on the side of cart for easy air supply connection and additional air hose.
DE-1200PB 	1	Pneumatic Control Box for Auto on/off	MV-DOF-V 	1	Dual Operator Vacuum Fitting
MV-412HA 	1	18' Coaxial Air Supply/ Vacuum Hose	MV-412HA-ADAP 	1	1-1/4" x 18" Adapter for Coaxial Vacuum Hose

Smart Cart - Autonet®





Body Repair - Pneumatic









Part Number

MUS-AEBSK-C

Abrasives Included:					
Part Number	QTY	Description	Part Number	QTY	Description
 AE24105080	1	Autonet® 6" Net Grip Disc P80	 AE24105018	1	Autonet® 6" Net Grip Disc P180
 AE-570-080	1	Autonet® 2-3/4" x 33' Net Grip Roll P80	 AE-570-180	1	Autonet® 2-3/4" x 33' Net Grip Roll P180
 9193500111	1	Dry Guide Coat - Black			



Tools Included:					
Part Number	QTY	Description	Part Number	QTY	Description
 MRP-680CV	1	6" Vacuum-Ready Finishing Sander (8mm orbit)	 MVHB35	1	Grip Faced Multi-Hole Vacuum Block 2-3/4" x 5"
 MR-38CV-1	1	2-3/4" x 7-3/4" Vacuum-Ready Orbital Sander (3mm orbit)	 MVHB38-K	1	Grip Faced Multi-Hole Vacuum Block Contour Kit 2-3/4" x 7-1/2"
			 9116R	1	Rigid Grip Faced Multi-Hole Vacuum Block 2-3/4" x 16-1/2"

Cart, Dust Extractor and Accessories Included:					
Part Number	QTY	Description	Part Number	QTY	Description
 MAI-CART-912	1	Smart Cart for Dust-Free Sanding	 91100-A	1	3/4" x 12' Vacuum Hose for Vacuum Hand Blocks
 DE-1230-PC	1	30 Liter Portable Dust Extractor with HEPA Filter	 MAI-CART-AUXAIR	1	Manifold and 36" auxiliary air line assembly mounted on the side of cart for easy air supply connection and additional air hose.
 DE-1200PB	1	Pneumatic Control Box for Auto on/off	 MV-DOF-V	1	Dual Operator Vacuum Fitting
 MV-412HA	1	18' Coaxial Air Supply/Vacuum Hose	 MV-412HA-ADAP	1	1-1/4" x 18" Adapter for Coaxial Vacuum Hose

Part Number

MUS-OSPPSK-C

Smart Cart - OSP

Paint Prep - Pneumatic











Abrasives Included:

Part Number	QTY	Description	Part Number	QTY	Description
OS-241-003 	1	OSP-3 Primer Preparation 6" Disc	OS-711-004 	1	OSP-4 Finishing 6" Disc
OS-570-003 	1	OSP-3 Body Filler Roll 2-3/4" x 33'	OS-127-004 	1	OSP-4 Finishing Pad 4-1/2" x 5"
2C-611-1000 	1	Q.Silver® Micro 6" 15-Hole Grip Disc P1000	9193500111 	1	Dry Guide Coat Black

Tools and Interface Pads Included:

Part Number	QTY	Description	Part Number	QTY	Description
MRP-650CV 	1	6" Vacuum-Ready Finishing Sander (5mm orbit)	MVHB35 	1	Grip Faced Multi-Hole Vacuum Block 2-3/4" x 5"
1066F 	1	6" Grip Faced (Firm) Interface Pad	MVHB38-K 	1	Grip Faced Multi-Hole Vacuum Block Contour Kit 2-3/4" x 7-1/2"
MR-38CV-1 	1	2-3/4" x 7-3/4" Vacuum-Ready Orbital Sander (3mm orbit)	9116R 	1	Rigid Grip Faced Multi-Hole Vacuum Block 2-3/4" x 16-1/2"

Cart, Dust Extractor and Accessories Included:

Part Number	QTY	Description	Part Number	QTY	Description
MAI-CART-912 	1	Smart Cart for Dust-Free Sanding	91100-A 	1	3/4" x 12' Vacuum Hose for Vacuum Hand Blocks
DE-1230-PC 	1	30 Liter Portable Dust Extractor with HEPA Filter	MAI-CART-AUXAIR 	1	Manifold and 36" auxiliary air line assembly mounted on the side of cart for easy air supply connection and additional air hose.
DE1200-PB 	1	Pneumatic Control Box for Auto on/off	MV-DOF-V 	1	Dual Operator Vacuum Fitting
MV-412HA 	1	18' Coaxial Air Supply/ Vacuum Hose	MV-412HA-ADAP 	1	1-1/4" x 18" Adapter for Coaxial Vacuum Hose

Smart Cart - Autonet®







Paint Prep - Pneumatic

Part Number

MUS-AEPSK-C











Abrasives Included:

Part Number	QTY	Description	Part Number	QTY	Description
AE24105032 	1	Autonet® 6" Net Grip Disc P320	23-645-500 	1	Gold Soft 6" 15-Hole Foam-Backed Grip Disc P500
AE-570-320 	1	Autonet® 2-3/4" x 33' Net Grip Roll P80	23-645-800 	1	Gold Soft 6" 15-Hole Foam-Backed Grip Disc P800
2C-611-1000 	1	Q.Silver® Micro 6" 15-Hole Grip Disc P1000	23-145-800 	1	Goldflex-Soft 4-1/2" x 5" Foam-Backed Abrasive Pad P800
9193500111 	1	Dry Guide Coat Black			

Tools and Interface Pads Included:

Part Number	QTY	Description	Part Number	QTY	Description
MRP-650CV 	1	6" Vacuum-Ready Finishing Sander (5mm orbit)	MVHB35 	1	Grip Faced Multi-Hole Vacuum Block 2-3/4" x 5"
1066F 	1	6" Grip Faced (Firm) Interface Pad	MVHB38-K 	1	Grip Faced Multi-Hole Vacuum Block Contour Kit 2-3/4" x 7-1/2"
MR-38CV-1 	1	2-3/4" x 7-3/4" Vacuum-Ready Orbital Sander (3mm orbit)	9116R 	1	Rigid Grip Faced Multi-Hole Vacuum Block 2-3/4" x 16-1/2"

Cart, Dust Extractor and Accessories Included:

Part Number	QTY	Description	Part Number	QTY	Description
MAI-CART-912 	1	Smart Cart for Dust-Free Sanding	91100-A 	1	3/4" x 12' Vacuum Hose for Vacuum Hand Blocks
DE-1230-PC 	1	30 Liter Portable Dust Extractor with HEPA Filter	MAI-CART-AUXAIR 	1	Manifold and 36" auxiliary air line assembly mounted on the side of cart for easy air supply connection and additional air hose.
DE1200-PB 	1	Pneumatic Control Box for Auto on/off	MV-DOF-V 	1	Dual Operator Vacuum Fitting
MV-412HA 	1	18' Coaxial Air Supply/Vacuum Hose	MV-412HA-ADAP 	1	1-1/4" x 18" Adapter for Coaxial Vacuum Hose

Trolley - OSP





Body Repair - Pneumatic











Abrasives Included:

Part Number	QTY	Description	Part Number	QTY	Description
 OS-241-001	1	OSP-1 Paint Removal 6" Disc	 OS-241-002	1	OSP-2 Feather Edge 6" Disc
 OS-570-001	1	OSP-1 Body Filler Roll 2-3/4" x 33'	 OS-570-002	1	OSP-2 Body Filler Roll 2-3/4" x 33'
 9193500111	1	Dry Guide Coat - Black			

Tools Included:

Part Number	QTY	Description	Part Number	QTY	Description
MRP-680CV	1	6" Vacuum-Ready Finishing Sander (8mm orbit) 	MVHB35	1	Grip Faced Multi-Hole Vacuum Block 2-3/4" x 5" 
MR-38CV-1	1	2-3/4" x 7-3/4" Vacuum-Ready Orbital Sander (3mm orbit) 	MVHB38-K	1	Grip Faced Multi-Hole Vacuum Block Contour Kit 2-3/4" x 7-1/2" 
			9116R	1	Rigid Grip Faced Multi-Hole Vacuum Block 2-3/4" x 16-1/2" 

Cart, Dust Extractor and Accessories Included:

Part Number	QTY	Description	Part Number	QTY	Description
 9190310111	1	Trolley Cart for Dust-Free Sanding	 91100-A	1	3/4" x 12' Vacuum Hose for Vacuum Hand Blocks
 DE-1230-PC	1	30 Liter Portable Dust Extractor with HEPA Filter	 MAI-CART-AUXAIR	1	Manifold and 36" auxiliary air line assembly can be mounted on the side of trolley for easy air supply connection and additional air hose.
 DE-1200PB	1	Pneumatic Control Box for Auto on/off	 MV-DOF-V	1	Dual Operator Vacuum Fitting
 MV-412HA	1	18' Coaxial Air Supply/ Vacuum Hose	 MV-412HA-ADAP	1	1-1/4" x 18" Adapter for Coaxial Vacuum Hose

Trolley - Autonet®

Body Repair - Pneumatic

Part Number





MUS-AEBSK-T

Abrasives Included:









Part Number	QTY	Description	Part Number	QTY	Description
AE24105080 	1	Autonet® 6" Net Grip Disc P80	AE24105018 	1	Autonet® 6" Net Grip Disc P180
AE-570-080 	1	Autonet® 2-3/4" x 33' Net Grip Roll P80	AE-570-180 	1	Autonet® 2-3/4" x 33' Net Grip Roll P180
9193500111 	1	Dry Guide Coat - Black			



Tools Included:

Part Number	QTY	Description	Part Number	QTY	Description
MRP-680CV 	1	6" Vacuum-Ready Finishing Sander (8mm orbit)	MVHB35 	1	Grip Faced Multi-Hole Vacuum Block 2-3/4" x 5"
MR-38CV-1 	1	2-3/4" x 7-3/4" Vacuum-Ready Orbital Sander (3mm orbit)	MVHB38-K 	1	Grip Faced Multi-Hole Vacuum Block Contour Kit 2-3/4" x 7-1/2"
			9116R 	1	Rigid Grip Faced Multi-Hole Vacuum Block 2-3/4" x 16-1/2"

Cart, Dust Extractor and Accessories Included:

Part Number	QTY	Description	Part Number	QTY	Description
9190310111 	1	Trolley Cart for Dust-Free Sanding	91100-A 	1	3/4" x 12' Vacuum Hose for Vacuum Hand Blocks
DE-1230-PC 	1	30 Liter Portable Dust Extractor with HEPA Filter	MAI-CART-AUXAIR 	1	Manifold and 36" auxiliary air line assembly can be mounted on the side of trolley for easy air supply connection and additional air hose.
DE-1200PB 	1	Pneumatic Control Box for Auto on/off	MV-DOF-V 	1	Dual Operator Vacuum Fitting
MV-412HA 	1	18' Coaxial Air Supply/Vacuum Hose	MV-412HA-ADAP 	1	1-1/4" x 18" Adapter for Coaxial Vacuum Hose







Part Number
MUS-OSPPSK-T

Trolley - OSP

Paint Prep - Pneumatic











Abrasives Included:

Part Number	QTY	Description	Part Number	QTY	Description
OS-241-003 	1	OSP-3 Primer Preparation 6" Disc	OS-711-004 	1	OSP-4 Finishing 6" Disc
OS-570-003 	1	OSP-3 Body Filler Roll 2-3/4" x 33'	OS-127-004 	1	OSP-4 Finishing Pad 4-1/2" x 5"
2C-611-1000 	1	Q.Silver® Micro 6" 15-Hole Grip Disc P1000	9193500111 	1	Dry Guide Coat Black

Tools and Interface Pads Included:

Part Number	QTY	Description	Part Number	QTY	Description
MRP-650CV 	1	6" Vacuum-Ready Finishing Sander (5mm orbit)	MVHB35 	1	Grip Faced Multi-Hole Vacuum Block 2-3/4" x 5"
1066F 	1	6" Grip Faced (Firm) Interface Pad	MVHB38-K 	1	Grip Faced Multi-Hole Vacuum Block Contour Kit 2-3/4" x 7-1/2"
MR-38CV-1 	1	2-3/4" x 7-3/4" Vacuum-Ready Orbital Sander (3mm orbit)	9116R 	1	Rigid Grip Faced Multi-Hole Vacuum Block 2-3/4" x 16-1/2"

Cart, Dust Extractor and Accessories Included:

Part Number	QTY	Description	Part Number	QTY	Description
9190310111 	1	Trolley Cart for Dust-Free Sanding	91100-A 	1	3/4" x 12' Vacuum Hose for Vacuum Hand Blocks
DE-1230-PC 	1	30 Liter Portable Dust Extractor with HEPA Filter	MAI-CART-AUXAIR 	1	Manifold and 36" auxiliary air line assembly can be mounted on the side of trolley for easy air supply connection and additional air hose.
DE-1200PB 	1	Pneumatic Control Box for Auto on/off	MV-DOF-V 	1	Dual Operator Vacuum Fitting
MV-412HA 	1	18' Coaxial Air Supply/ Vacuum Hose	MV-412HA-ADAP 	1	1-1/4" x 18" Adapter for Coaxial Vacuum Hose







Trolley - Autonet®

Paint Prep - Pneumatic

Part Number

MUS-AEPSK-T

Abrasives Included:









Part Number	QTY	Description	Part Number	Description
AE24105032 	1	Autonet® 6" Net Grip Disc P320	23-645-500 	Gold Soft 6" 15-Hole Foam-Backed Grip Disc P500
AE-570-320 	1	Autonet® 2-3/4" x 33' Net Grip Roll P80	23-645-800 	Gold Soft 6" 15-Hole Foam-Backed Grip Disc P800
2C-611-1000 	1	Q.Silver® Micro 6" 15-Hole Grip Disc P1000	23-145-800 	Goldflex-Soft 4-1/2" x 5" Foam-Backed Abrasive Pad P800
9193500111 	1	Dry Guide Coat Black		



Tools and Interface Pads Included:

Part Number	QTY	Description	Part Number	QTY	Description
MRP-650CV 	1	6" Vacuum-Ready Finishing Sander (5mm orbit)	MVHB35 	1	Grip Faced Multi-Hole Vacuum Block 2-3/4" x 5"
1066F 	1	6" Grip Faced (Firm) Interface Pad	MVHB38-K 	1	Grip Faced Multi-Hole Vacuum Block Contour Kit 2-3/4" x 7-1/2"
MR-38CV-1 	1	2-3/4" x 7-3/4" Vacuum-Ready Orbital Sander (3mm orbit)	9116R 	1	Rigid Grip Faced Multi-Hole Vacuum Block 2-3/4" x 16-1/2"

Cart, Dust Extractor and Accessories Included:

Part Number	QTY	Description	Part Number	QTY	Description
9190310111 	1	Trolley Cart for Dust-Free Sanding	91100-A 	1	3/4" x 12' Vacuum Hose for Vacuum Hand Blocks
DE-1230-PC 	1	30 Liter Portable Dust Extractor with HEPA Filter	MAI-CART-AUXAIR 	1	Manifold and 36" auxiliary air line assembly can be mounted on the side of trolley for easy air supply connection and additional air hose.
DE-1200PB 	1	Pneumatic Control Box for Auto on/off	MV-DOF-V 	1	Dual Operator Vacuum Fitting
MV-412HA 	1	18' Coaxial Air Supply/Vacuum Hose	MV-412HA-ADAP 	1	1-1/4" x 18" Adapter for Coaxial Vacuum Hose



Breathe easy with Mirka's Cart & Trolley Dust-Free Systems

3" Components

- Pneumatic & Electric Tools
- OSP Abrasives
- Autonet[®] Abrasives

All Mirka[®] 3" components can be purchased individually.

Pneumatic 3" Sander



MR-350CV
3" Pneumatic Vac-Ready
Finishing Sander

DEROS Electric 3" Sander



my Mirka Bluetooth

MID350201US
3" Electric Vac-Ready
Finishing Sander

3" Interface Pad



9133
Interface Pad 3"

Go mobile with the Workstation accessory!

With the Mirka DE-1230 workstation, your tools, abrasives and accessories will always be within arms reach. This storage solution attaches securely to the top of the dust extractor using the DE-TCFS fastening system, making it perfect for small spaces.

Part number: DE-WS

3 Layers of Dust Protection and Filtration



DE-FDB
Fleece dust bag



DE-FILT
Flat filter



DE-HEPA
HEPA filter



DE-HANDLE
Handle extension



DE-TCFS
Mirka tool case fastening system



Pneumatic box
DE-1200PB

Dust Extractor (HEPA)
DE-1230-PC

OSP Body Repair



OS-203-001
OSP-1 3" Disc
Paint Removal



OS-203-002
OSP-2 3" Disc
Feather Edge

OSP Paint Prep



OS-203-003
OSP 3 3" Disc
Primer Preparation



OS-734-004
OSP-4 3" 6-Hole
Finishing Disc

Autonet® Body Repair



AE-203-080
Autonet® 3"
Net Grip Disc P80



AE-203-180
Autonet® 3"
Net Grip Disc P180

Autonet® and Q.Silver® Micro Paint Prep



AE-203-320
Autonet® 3"
Net Grip Disc P320



AE-203-800
Autonet® 3"
Net Grip Disc P800



AE-203-600
Autonet® 3"
Net Grip Disc P600







2C-608-1000
Q. Silver® Micro 3"
Grip Disc P1000

Smart Cart - OSP



Body Repair - Electric

Abrasives Included:







Part Number	QTY	Description	Part Number	QTY	Description
 OS-241-001	1	OSP-1 Paint Removal 6" Disc	 OS-241-002	1	OSP-2 Feather Edge 6" Disc
 OS-570-001	1	OSP-1 Body Filler Roll 2-3/4" x 33'	 OS-570-002	1	OSP-2 Body Filler Roll 2-3/4" x 33'
 9193500111	1	Dry Guide Coat - Black			



Tools Included:

Part Number	QTY	Description	Part Number	QTY	Description
 MID65020CAUS my Mirka Bluetooth	1	6" DEROS Vacuum-Ready Random Electric Orbital Sander (5mm orbit)	 MVHB35	1	Grip Faced Multi-Hole Vacuum Block 2-3/4" x 5"
 MID3830201US my Mirka Bluetooth	1	2-3/4" x 7-3/4" Vacuum-Ready Electric Orbital Sander (3mm orbit)	 MVHB38-K	1	Grip Faced Multi-Hole Vacuum Block Contour Kit 2-3/4" x 7-1/2"
			 9116R	1	Rigid Grip Faced Multi-Hole Vacuum Block 2-3/4" x 16-1/2"

Cart, Dust Extractor and Accessories Included:

Part Number	QTY	Description	Part Number	QTY	Description
 MAI-CART-912	1	Smart Cart for Dust-Free Sanding	 91100-A	1	3/4" x 12' Vacuum Hose for Vacuum Hand Blocks
 DE-1230-PC	1	30 Liter Portable Dust Extractor with HEPA Filter	 MV-DOF-V	1	Dual Operator Vacuum Fitting
 MVHA-5	1	18' Coaxial Electric Supply/ Vacuum Hose	 MV-412HA-ADAP	1	1-1/4" x 18" Adapter for Coaxial Vacuum Hose





Smart Cart - Autonet®

Body Repair - Electric

Part Number

MUS-AEBSK-CE

Abrasives Included:







Part Number	QTY	Description	Part Number	QTY	Description
AE24105080 	1	Autonet® 6" Net Grip Disc P80	AE24105018 	1	Autonet® 6" Net Grip Disc P180
AE-570-180 	1	Autonet® 2-3/4" x 33' Net Grip Roll P80	AE-570-180 	1	Autonet® 2-3/4" x 33' Net Grip Roll P180
9193500111 	1	Dry Guide Coat - Black			



Tools Included:

Part Number	QTY	Description	Part Number	QTY	Description
MID65020CAUS  my Mirka Bluetooth®	1	6" DEROS Vacuum-Ready Random Electric Orbital Sander (5mm orbit)	MVHB35 	1	Grip Faced Multi-Hole Vacuum Block 2-3/4" x 5"
MID3830201US  my Mirka Bluetooth®	1	2-3/4" x 7-3/4" Vacuum-Ready Electric Orbital Sander (3mm orbit)	MVHB38-K 	1	Grip Faced Multi-Hole Vacuum Block Contour Kit 2-3/4" x 7-1/2"
			9116R 	1	Rigid Grip Faced Multi-Hole Vacuum Block 2-3/4" x 16-1/2"

Cart, Dust Extractor and Accessories Included:

Part Number	QTY	Description	Part Number	QTY	Description
MAI-CART-912 	1	Smart Cart for Dust-Free Sanding	91100-A 	1	3/4" x 12' Vacuum Hose for Vacuum Hand Blocks
DE-1230-PC 	1	30 Liter Portable Dust Extractor with HEPA Filter	MV-DOF-V 	1	Dual Operator Vacuum Fitting
MVHA-5 	1	18' Coaxial Electric Supply/ Vacuum Hose	MV-412HA-ADAP 	1	1-1/4" x 18" Adapter for Coaxial Vacuum Hose

Smart Cart - OSP



Paint Prep - Electric

Abrasives Included:







Part Number	QTY	Description	Part Number	QTY	Description
OS-241-003 	1	OSP-3 Primer Preparation 6" Disc	OS-711-004 	1	OSP-4 Finishing 6" Disc
OS-570-003 	1	OSP-3 Body Filler Roll 2-3/4" x 33'	OS-127-004 	1	OSP-4 Finishing Pad 4-1/2" x 5"
2C-611-1000 	1	Q.Silver® Micro 6" 15-Hole Grip Disc P1000	9193500111 	1	Dry Guide Coat Black



Tools Included:

Part Number	QTY	Description	Part Number	QTY	Description
MID65020CAUS  my Mirka Bluetooth	1	6" DEROS Vacuum-Ready Random Electric Orbital Sander (5mm orbit)	MVHB35 	1	Grip Faced Multi-Hole Vacuum Block 2-3/4" x 5"
MID3830201US  my Mirka Bluetooth	1	2-3/4" x 7-3/4" Vacuum-Ready Electric Orbital Sander (3mm orbit)	MVHB38-K 	1	Grip Faced Multi-Hole Vacuum Block Contour Kit 2-3/4" x 7-1/2"
			9116R 	1	Rigid Grip Faced Multi-Hole Vacuum Block 2-3/4" x 16-1/2"

Cart, Dust Extractor and Accessories Included:

Part Number	QTY	Description	Part Number	QTY	Description
MAI-CART-912 	1	Smart Cart for Dust-Free Sanding	91100-A 	1	3/4" x 12' Vacuum Hose for Vacuum Hand Blocks
DE-1230-PC 	1	30 Liter Portable Dust Extractor with HEPA Filter	MV-DOF-V 	1	Dual Operator Vacuum Fitting
MVHA-5 	1	18' Coaxial Electric Supply/ Vacuum Hose	MV-412HA-ADAP 	1	1-1/4" x 18" Adapter for Coaxial Vacuum Hose







Smart Cart - Autonet®

Paint Prep - Electric

Part Number

MUS-AEPSK-CE

Abrasives Included:







Part Number	QTY	Description	Part Number	QTY	Description
AE2410532 	1	Autonet® 6" Net Grip Disc P320	23-645-500 	1	Gold Soft 6" 15-Hole Foam-Backed Grip Disc P500
AE-570-320 	1	Autonet® 2-3/4" x 33' Net Grip Roll P320	23-645-800 	1	Gold Soft 6" 15-Hole Foam-Backed Grip Disc P800
23-145-800 	1	Goldflex-Soft 4-1/2" x 5" Foam-Backed Abrasive Pad P800	2C-611-1000 	1	Q.Silver® Micro 6" 15-Hole Grip Disc P1000
9193500111 	1	Dry Guide Coat Black			



Tools and Interface Pads Included:

Part Number	QTY	Description	Part Number	QTY	Description
MID65020CAUS 	1	6" Deros Vacuum-Ready Random Electric Orbital Sander (5mm orbit)	MVHB35 	1	Grip Faced Multi-Hole Vacuum Block 2-3/4" x 5"
1066F 	1	6" Grip Faced (Firm) Interface Pad	MVHB38-K 	1	Grip Faced Multi-Hole Vacuum Block Contour Kit 2-3/4" x 7-1/2"
MID3830201US 	1	2-3/4" x 7-3/4" Vacuum-Ready Electric Orbital Sander (3mm orbit)	9116R 	1	Rigid Grip Faced Multi-Hole Vacuum Block 2-3/4" x 16-1/2"

Cart, Dust Extractor and Accessories Included:

Part Number	QTY	Description	Part Number	QTY	Description
MAI-CART-912 	1	Smart Cart for Dust-Free Sanding	91100-A 	1	3/4" x 12' Vacuum Hose for Vacuum Hand Blocks
DE-1230-PC 	1	30 Liter Portable Dust Extractor with HEPA Filter	MV-DOF-V 	1	Dual Operator Vacuum Fitting
MVHA-5 	1	18' Coaxial Electric Supply/ Vacuum Hose	MV-412HA-ADAP 	1	1-1/4" x 18" Adapter for Coaxial Vacuum Hose

Trolley - OSP

Body Repair - Electric









Abrasives Included:

Part Number	QTY	Description	Part Number	QTY	Description
OS-241-001 	1	OSP-1 Paint Removal 6" Disc	OS-241-002 	1	OSP-2 Feather Edge 6" Disc
OS-570-001 	1	OSP-1 Body Filler Roll 2-3/4" x 33'	OS-570-002 	1	OSP-2 Body Filler Roll 2-3/4" x 33'
9193500111 	1	Dry Guide Coat - Black			

Tools Included:

Part Number	QTY	Description	Part Number	QTY	Description
MID65020CAUS 	1	6" DERSO Vacuum-Ready Random Electric Orbital Sander (5mm orbit)	MVHB35 	1	Grip Faced Multi-Hole Vacuum Block 2-3/4" x 5"
MID3830201US 	1	2-3/4" x 7-3/4" Vacuum-Ready Electric Orbital Sander (3mm orbit)	MVHB38-K 	1	Grip Faced Multi-Hole Vacuum Block Contour Kit 2-3/4" x 7-1/2"
			9116R 	1	Rigid Grip Faced Multi-Hole Vacuum Block 2-3/4" x 16-1/2"

Cart, Dust Extractor and Accessories Included:

Part Number	QTY	Description	Part Number	QTY	Description
9190310111 	1	Trolley Cart for Dust-Free Sanding	91100-A 	1	3/4" x 12' Vacuum Hose for Vacuum Hand Blocks
DE-1230-PC 	1	30 Liter Portable Dust Extractor with HEPA Filter	MV-DOF-V 	1	Dual Operator Vacuum Fitting
MVHA-5 	1	18' Coaxial Electric Supply/ Vacuum Hose	MV-412HA-ADAP 	1	1-1/4" x 18" Adapter for Coaxial Vacuum Hose





Trolley - Autonet®

Body Repair - Electric

Part Number



MUS-AEBSK-TE

Abrasives Included:







Part Number	QTY	Description	Part Number	QTY	Description
AE24105080 	1	Autonet® 6" Net Grip Disc P80	AE24105018 	1	Autonet® 6" Net Grip Disc P180
AE-570-080 	1	Autonet® 2-3/4" x 33' Net Grip Roll P80	AE-570-180 	1	Autonet® 2-3/4" x 33' Net Grip Roll P180
9193500111 	1	Dry Guide Coat - Black			



Tools Included:

Part Number	QTY	Description	Part Number	QTY	Description
MID65020CAUS  my Mirka Bluetooth®	1	6" DEROS Vacuum-Ready Random Electric Orbital Sander (5mm orbit)	MVHB35 	1	Grip Faced Multi-Hole Vacuum Block 2-3/4" x 5"
MID3830201US  my Mirka Bluetooth®	1	2-3/4" x 7-3/4" Vacuum-Ready Electric Orbital Sander (3mm orbit)	MVHB38-K 	1	Grip Faced Multi-Hole Vacuum Block Contour Kit 2-3/4" x 7-1/2"
			9116R 	1	Rigid Grip Faced Multi-Hole Vacuum Block 2-3/4" x 16-1/2"

Cart, Dust Extractor and Accessories Included:

Part Number	QTY	Description	Part Number	QTY	Description
9190310111 	1	Trolley Cart for Dust-Free Sanding	91100-A 	1	3/4" x 12' Vacuum Hose for Vacuum Hand Blocks
DE-1230-PC 	1	30 Liter Portable Dust Extractor with HEPA Filter	MV-DOF-V 	1	Dual Operator Vacuum Fitting
MVHA-5 	1	18' Coaxial Electric Supply/Vacuum Hose	MV-412HA-ADAP 	1	1-1/4" x 18" Adapter for Coaxial Vacuum Hose

Part Number





MUS-OSPPSK-TE

Trolley - OSP





Paint Prep - Electric







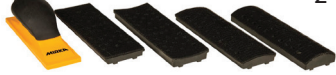

Abrasives Included:

Part Number	QTY	Description	Part Number	QTY	Description
OS-241-003 	1	OSP-3 Primer Preparation 6" Disc	OS-711-004 	1	OSP-4 Finishing 6" Disc
OS-570-003 	1	OSP-3 Body Filler Roll 2-3/4" x 33'	OS-127-004 	1	OSP-4 Finishing Pad 4-1/2" x 5"
2C-611-1000 	1	Q.Silver® Micro 6" 15-Hole Grip Disc P1000	9193500111 	1	Dry Guide Coat Black

Tools Included:

Part Number	QTY	Description	Part Number	QTY	Description
MID65020CAUS  my Mirka Bluetooth	1	6" DERSOS Vacuum-Ready Random Electric Orbital Sander (5mm orbit)	MVHB35 	1	Grip Faced Multi-Hole Vacuum Block 2-3/4" x 5"
MID3830201US  my Mirka Bluetooth	1	2-3/4" x 7-3/4" Vacuum-Ready Electric Orbital Sander (3mm orbit)	MVHB38-K 	1	Grip Faced Multi-Hole Vacuum Block Contour Kit 2-3/4" x 7-1/2"
			9116R 	1	Rigid Grip Faced Multi-Hole Vacuum Block 2-3/4" x 16-1/2"

Cart, Dust Extractor and Accessories Included:

Part Number	QTY	Description	Part Number	QTY	Description
9190310111 	1	Trolley Cart for Dust-Free Sanding	91100-A 	1	3/4" x 12' Vacuum Hose for Vacuum Hand Blocks
DE-1230 PC 	1	30 Liter Portable Dust Extractor with HEPA Filter	MV-DOF-V 	1	Dual Operator Vacuum Fitting
MVHA-5 	1	18' Coaxial Electric Supply/ Vacuum Hose	MV-412HA-ADAP 	1	1-1/4" x 18" Adapter for Coaxial Vacuum Hose







Trolley - Autonet®

Paint Prep - Electric

Part Number

MUS-AEPSK-TE

Abrasives Included:







Part Number	QTY	Description	Part Number	QTY	Description
AE2410532 	1	Autonet® 6" Net Grip Disc P320	23-645-500 	1	Gold Soft 6" 15-Hole Foam-Backed Grip Disc P500
AE-570-320 	1	Autonet® 2-3/4" x 33' Net Grip Roll P320	23-645-800 	1	Gold Soft 6" 15-Hole Foam-Backed Grip Disc P800
23-145-800 	1	Goldflex-Soft 4-1/2" x 5" Foam-Backed Abrasive Pad P800	2C-611-1000 	1	Q.Silver® Micro 6" 15-Hole Grip Disc P1000
9193500111 	1	Dry Guide Coat Black			



Tools and Interface Pads Included:

Part Number	QTY	Description	Part Number	QTY	Description
MID65020CAUS 	1	6" DEROS Vacuum-Ready Random Electric Orbital Sander (5mm orbit) 	MVHB35	1	Grip Faced Multi-Hole Vacuum Block 2-3/4" x 5" 
1066F	1	6" Grip Faced (Firm) Interface Pad 	MVHB38-K	1	Grip Faced Multi-Hole Vacuum Block Contour Kit 2-3/4" x 7-1/2" 
MID3830201US 	1	2-3/4" x 7-3/4" Vacuum-Ready Electric Orbital Sander (3mm orbit) 	9116R	1	Rigid Grip Faced Multi-Hole Vacuum Block 2-3/4" x 16-1/2" 

Cart, Dust Extractor and Accessories Included:

Part Number	QTY	Description	Part Number	QTY	Description
9190310111 	1	Trolley Cart for Dust-Free Sanding	91100-A 	1	3/4" x 12' Vacuum Hose for Vacuum Hand Blocks
DE-1230-PC 	1	30 Liter Portable Dust Extractor with HEPA Filter	MV-DOF-V 	1	Dual Operator Vacuum Fitting
MVHA-5 	1	18' Coaxial Electric Supply/Vacuum Hose	MV-412HA-ADAP 	1	1-1/4" x 18" Adapter for Coaxial Vacuum Hose

ELECTRIC DUST-FREE SYSTEMS



MID650-912-5		
Includes:	QTY	Description
MID65020CAUS	1	6" DEROS Vacuum-Ready Random Electric Orbital Sander (5mm orbit) w/ case
MVHA-5	1	5m (13') Coaxial Electric Supply/ Vacuum Hose
DE-1230-PC	1	30 Liter Portable HEPA filter Dust Extractor



MID650-912-10		
Includes:	QTY	Description
MID65020CAUS	1	6" DEROS Vacuum-Ready Random Electric Orbital Sander (5mm orbit) w/ case
MVHA-10	1	10m (33') Coaxial Electric Supply/ Vacuum Hose
DE-1230-PC	1	30 Liter Portable HEPA filter Dust Extractor



Electric Hand Block Sander		
Part Number:	QTY	Description
MID3830201US	1	2-3/4" x 7-3/4" DEOS Vacuum-Ready Electric Orbital Sander (3mm orbit)

Dust-Free Perfection Starts With Mirka®



Mirka® DEOS / Mirka® DEROS

Autonet® Mesh Abrasives

Vacuum Hose

Dust Extractor

PNEUMATIC DUST-FREE SYSTEMS



MRP650-912		
Includes:	QTY	Description
MRP-650CV	1	6" Vacuum-Ready Finishing Sander (5mm orbit) w/ case
MV412-HA	1	15' Coaxial Air Supply/ Vacuum Hose
DE-1230-PC	1	30 Liter Portable HEPA filter Dust Extractor
DE-1200PB	1	Pneumatic Control Box for Auto on/off



MRP650-912-33		
Includes:	QTY	Description
MRP-650CV	1	6" Vacuum-Ready Finishing Sander (5mm orbit) w/ case
MV-HA33	1	33' Coaxial Vacuum Hose Extension
DE-1230-PC	1	30 Liter Portable HEPA filter Dust Extractor
DE-1200PB	1	Pneumatic Control Box for Auto on/off



Pneumatic Hand Block Sander		
Part Number:	QTY	Description
MR-38CV-1	1	2-3/4" x 7-3/4" Vacuum-Ready Random Orbital Sander (3mm orbit)

Dust-Free Perfection Starts With Mirka®



MR-38CV-1 / Mirka® PROS

Autonet® Mesh Abrasives

Vacuum Hose

Dust Extractor

Mirka Hoses



Hoses come with all pieces and connections shown.

Mirka® DEROS / DEOS

Vacuum side
➔

Tool side
←

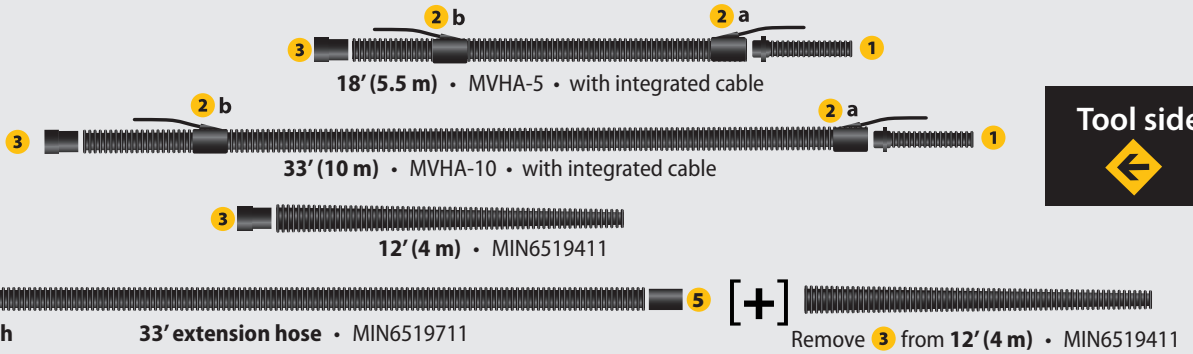

Mirka® PROS / MR

Vacuum side
➔

Tool side
←

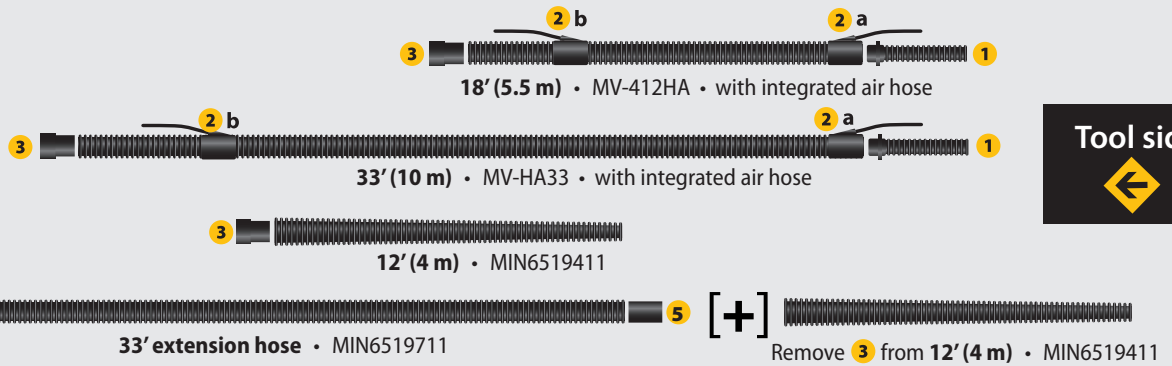

Hand Sanding Blocks

Vacuum side
➔

Tool side
←

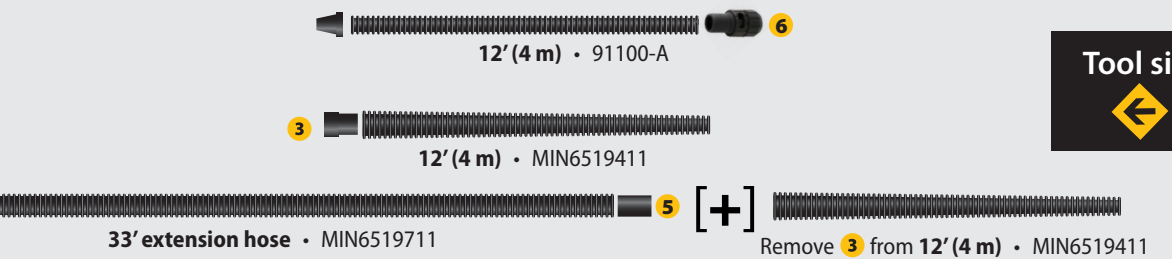

All hoses and adapters work with the Mirka DE-1230-PC dust extractor. Adapters 1-6 can be ordered as spare parts.



MVHA-5 (18') • MVHA-10 (33')



MV-412HA (15') • MV-HA33 (33')



91100-A



MIN6519411

Mirka Adapters





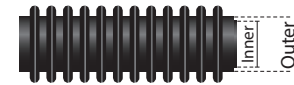

Mirka® DEROS / DEOS		Ø to Sander (mm)	
Part #	Hose diameters and length	Inner	Outer
MVHA-5	Hose 1-1/2" x 18' • with Integrated Cable	25	27 / 32
MVHA-10	Hose 1-1/2" x 33' • with Integrated Cable	25	27 / 32
MIN6519411	Hose 1-1/2" x 12' + Connector	25	27 / 32
MIN6519711	Extension Hose 1-1/2" x 33'	25	27 / 32

Mirka® PROS / ROS / MR Series		Ø to Sander (mm)	
Part #	Hose diameters and length	Inner	Outer
MV-412HA	Hose 1-1/2" x 15' • with Integrated air hose	25	27 / 32
MV-HA33	Hose 1-1/2" x 33' • with Integrated air hose	25	27 / 32
MIN6519411	Hose 1-1/2" x 12' + Connector	25	27 / 32
MIN6519711	Extension Hose 1-1/2" x 33'	25	27 / 32

Hand Sanding Blocks		Ø to Sander (mm)	
Part #	Hose diameters and length	Inner	Outer
91100-A	Hose 3/4" x 12' + Connector	20	22 / 26
MIN6519411	Tapered Hose 1-1/2" to 1-1/4" x 12' + Connector	22	27 / 32
MIN6519711	Extension Hose 1-1/2" x 33'	25	27 / 32



→ All hoses and adapters work with the Mirka DE-1230-PC dust extractor. Adapters 1–6 can be ordered as spare parts.

Adapter	Description
 MV-412HA-ADAP	1 Hose 1-1/2" x 15' + Connector. This conductive adapter enables a quick change in-between Mirka power tools. Fix the adapter on each tool and connect/disconnect to/from any Mirka hose assembly with a Mirka branded adapter, both pneumatic: MV-412HA, MV-HA33, and electric: MVHA-5 and MVHA-10.
 VHA-1.25	2 a Mirka Connector for Air + Electric Hoses. Comes with hoses MVHA-5, MVHA-10, MV-412HA, MV-HA33.
 8992515911	2 b Connector for Air + Electric Hoses with threads. This adapter is close to the dust extractor, where the pneumatic hose/electrical cable comes out. Comes with hoses MVHA-5, MVHA-10, MV-412HA, MV-HA33.
 8992515611	3 Hose adapter Ø 32 mm / 54 mm for Mirka® Dust Extractors. Comes with hoses MVHA-5, MVHA-10, MV-412HA, MV-HA33. This adapter goes from the hose into the dust extractor.
 8992515411	4 Soft Connector Ø 25,4 mm. Delivered together with hose MIN6519411. For connecting the hose to the Mirka Deco Sander.
 MV-HC32	5 Hose Connector Ø 32 / 32 mm. Delivered together with extension hose MIN6519711. Enables connection with MIN6519411.
 8391111211	6 Quick -disconnect air inlet for Hand Blocks. Comes with hose 91100-A

MIRKA

Mirka USA

2375 Edison Blvd.
Twinsburg, Ohio 44087
Tel. 800.843.3904
sales.us@mirka.com

www.mirka.com
www.mirkacollision.us

