



Automotive Aftermarket Products & Systems Catalog

*Serving the automotive aftermarket refinish, detailing,
mechanical service and repair professional for generations.*



www.3M.com/automotive



QUICK REFERENCE

3M™ PPS™ Paint Preparation Systems 5–14

Abrasives 15–66

Paint Finishing and Vehicle Appearance 67–92

Tapes 93–110

Masking Systems 111–116

Safety 117–140

Adhesives, Coatings and Sealers 141–164

Auto Glass Installation 165–176

Mechanical and Electrical 177–200

Scotch-Brite™ Products 201–208

Body Repair 209–214

Decorative, Protective, Reflective Products 215–231

Index by Part Number 232–240

3M Automotive Aftermarket Product Index

3M™ PPS™ PAINT PREPARATION SYSTEMS	5–14
Accessories	12, 13–14
Adapters	8–11
Inserts	12
Kits, Dispensers	7, 12, 14
Lids, Liners, Cups and Collars	7
Spray Guns, Parts and Accessories	13–14
ABRASIVES	15–66
3M Abrasive Accessories	42–60
Quick Reference Chart	42–43
3M Abrasives	15–41
3M Performance Class Abrasives (Discs, Disc Rolls, Sheets)	18–23
Quick Reference Chart	18–19
3M™ Imperial™ Abrasives	20–23
Hookit™ II	20, 22
Stikit™	21, 23
Dry	21
Dust-Free	20, 22–23
Fibre	20
3M™ Trizact™ Hookit™ II Abrasives	23
3M Standard Class Abrasives (Cut-Off Wheels, Discs, Disc Rolls, Sheets)	24–29
Quick Reference Chart	24–25
3M™ Green Corps™ Abrasives	26–29
Hookit™ Regalite™	26
Stikit™ Production™	27
Roloc™	29
Dry Production™	28
Dust-Free	26–28
Fibre	29
3M™ Stikit™ Green Fre-Cut™ Abrasives	28
Dust-Free	28
3M Standard Class Abrasives (Discs, Disc Rolls, Film, Finishing Film, Sheets, Sheet Rolls)	30–35
Quick Reference Chart	30–31
3M™ Hookit™ Gold Abrasives	32
Dust-Free	32
3M™ Hookit™	35
Dust-Free	35
3M™ Stikit™ Gold and Stikit™ Production™ Gold Abrasives	32–33
Dust-Free	33
3M™ Stikit™	34–35
Gold Dry	34
3M Utility Class Abrasives (Cut-Off Wheels, Discs, Disc Rolls, Sheets, Paper Sheets, Sponge Sheets)	36–39
Quick Reference Chart	36
3M™ Stikit™ Production™	38
3M™ Stikit™ Tri-M-ite™ Fre-Cut™	39
3M™ Tri-M-ite™ Fre-Cut™	39
3M™ Tri-M-ite™ Resin Bond	38
3M™ Production™	38
3M™ Wetordry™ Abrasives (Discs, Paper Sheets)	40–41
Quick Reference Chart	40
3M™ Imperial™	41
3M™ Finesse-It™ Imperial™	41
3M™ Tri-M-ite™	41
3M Job-Packed Abrasives and Accessories	61–64
3M Retail Abrasives and Accessories	65–66

NOTE: For index by part number, see pages 232–240.

3M Automotive Aftermarket Product Index

PAINT FINISHING AND VEHICLE APPEARANCE	67–92
Body Shop Clean-Up	87–88
Buffing/Compounding Pads and Accessories	79–81, 85
Foam	80
Wool	79
Car Care Product Line	69–73
Cleaners/Conditioners	87
Detailing Products	89–91
Diluters	87–88, 91
Foam Discs and Disc Pads	82–83
Glazes (Machine and Hand Applied)	81–82, 85
Paint Booth Protection	69
3M™ Perfect-It™ 3000	74–78, 82, 85
Polishing Pads and Accessories	83–84
Putties	87
Retail Appearance Products	92
Rubbing Compounds	78
Scrubbers, Sponges, Wipes	86, 92
Surface Preparation	79
Waxes	86
TAPES	93–110
Adhesive Transfer Tape and Dispenser	108
Attachment Tapes	98–99
Duct Tapes	100–101
Electrical Tapes	108–109
Fastening Tapes	107
3M™ Scotchmate™ Hook-and-Loop	107
3M™ Dual Lock™	107
Foam Tapes	100
Masking Tapes	95–97
Application Guide	95
233 and 233+	96
2727	97
2308	97
Packaging Tapes	101–105
Box Sealing	102–104
Dispensers	105
Filament	101
Label Protection	102
Paint Striping (Fine Line) Tapes	98
Retail Tape Products	110
Soft Edge Foam Masking Tapes (S.E.F.M.T./D.A.R.T.)	96
Specialty and Specialty Packaging Tapes	106
Vinyl Tape (471)	106
MASKING SYSTEMS	111–116
Hand Masking	115–116
Blades	115
Dispensers	115–116
Films	116
Kits	116
Masking Equipment	114–115
Apron Tapers	114–115
Masks	114–115
Masking Paper	113
Overspray Masking Liquid	116
Overspray Protective Sheeting (Plastic Sheeting)	113

NOTE: For index by part number, see pages 232–240.

3M Automotive Aftermarket Product Index

SAFETY	117–140
Air-Supplied Respirator Systems	127–131
Head, Eye and Face Protection	133–136
Hearing Protection	124
3M™ Nomad™ Carpet Matting	137
Oil Spill and Fluid Recovery Sorbents	132
Personal Care/Comfort Products	124
Bandages	124
Hand Cleaner	124
Respirators and Dust Masks	119–123, 125–126
Retail Safety Products	140
Safety Glasses	133–134
Safety Helmets	133
3M™ Safety-Walk™ Products and Accessories	138–139
3M™ Speedglas™ Welding Lenses and Accessories	134–136
3M™ Vanguard™ Lenses	140
ADHESIVES, COATINGS AND SEALERS	141–164
Adhesives	153–155
Applicator Guns and Accessories	146
3M™ Automix™ Product Line	143–146
Coatings	160–163
Duramix™ Product Line	147–152
Emblem Adhesives	154
Plastic Parts/Bumper Repair	153
Retail Products	164
Seam Sealers	156–159
Silicone Sealants	159
Weatherstrip Adhesives	153
Welding Products	152
AUTO GLASS INSTALLATION	165–176
Applicator Guns and Accessories	175–176
Glass Cleaners	174
Glass Primers	171
Glass Sealants	174
Glass Shop Belts	173
Ribbon Sealers	173
Urethane Primers	171
Windshield Adhesives, Urethanes	171–172
MECHANICAL AND ELECTRICAL	177–200
Brake Cleaner and Repair Products	181
Brake Rotor Discs	181
Cable Ties/Electrical	193–194
Connectors/Electrical	194–195
Displays and Accessories	192
Fuel System Cleaners	186–191
FSC Guides	186–187, 189
FSC Hardware and Adapters	188–189, 191
FSC Tank Additives	190
Fuse Holder/Electrical	198
Heat Shrink Tubing	198–199
Intake System Cleaner	185
Machine Shop Products	180
Mechanical Cleaners and Lubricants	183–185
Mechanical Sealants and Adhesives	182–183
Professional Shop Rolls and Cloth Sheets	179–180
Retail Electrical Products	200
Terminals/Electrical	196
Wire Marker Tapes (Dispensers) and Crimping Tools	196–197

NOTE: For index by part number, see pages 232–240.

3M Automotive Aftermarket Product Index

SCOTCH-BRITE™ PRODUCTS	201–208
Bench Motor Wheel	205
Clean & Strip Discs/Wheels	204–205
Disc Pad Assemblies	205
Gasket Removal Discs (Cookies) and Accessories	207
Hand Pads	203–205
Scotch-Brite™ Radial Bristle Discs	207
Retail Scotch-Brite™ Products	208
Rivet Cleaning Disc Wheels	203
Scotch-Brite™ Roloc™ Bristle Discs	206
Scuffing Discs, Pads, Rolls, Wheels	203–205
Surface Conditioning Discs	206
BODY REPAIR	209–214
Accessories	214
Body Fillers	211–212
Dry Guide Coat	214
Putties (One-Part or Two-Part)	212–213
Resins	213
DECORATIVE, PROTECTIVE, REFLECTIVE PRODUCTS	215–231
Accessories	231
Reflective Conspicuity Markings (Trailer Markings)	217–218
Retail Reflective Products	231
3M™ Scotchcal™ Signwriter Film	229
3M™ Scotchcal™ Striping Tapes	221–229
Scotchgard™ Paint Protection Film (PPF)	220
3M™ Scotchlite™ Reflective Striping	230
Stripe/Molding Removal Products, Wheels and Discs	219
REFERENCE GUIDES AND APPLICATION CHARTS	
3M Abrasive Accessories Chart	42–43
3M Abrasive Accessories Reference Guide	57–60
3M Abrasives Products Guides (Quick Reference Charts)	
3M Performance Class Abrasives (Purple) Chart	18–19
3M Standard Class Abrasives (Green) Chart	24–25
3M Standard Class Abrasives (Gold) Chart	30–31
3M Utility Class Abrasives (Gray) Chart	36
3M™ Wetordry™ Abrasives (Black) Chart	40
Auto Glass Replacement Instructions	167–170
Automotive Respirators Selection Guide	125–126
Coatings Application Guide	160–161
D/A Backup Pad Guide	44
Fuel System Cleaner/Fuel Injector Cleaner Adapters Chart	191
Fuel System Cleaner Guide	186–187
Masking Systems Application Guide	95
3M™ Perfect-It™ 3000 Guide	74–77
Sealants Application Guide	156–157
Striping Tape Color Availability Grid	221–223

NOTE: For index by part number, see pages 232–240.

3M™ PPS™ Paint Preparation Systems



Products

Accessories 12-14

Adapters 8-11

Inserts 12

Kits, Dispensers 7, 12, 14

Lids, Liners, Cups
and Collars 7

Spray Guns, Parts
and Accessories 13-14

3M™ PPS™ Paint Preparation Systems



3M Innovation

3M™ PPS™ Paint Preparation Systems*

3M™ PPS™ Paint Preparation System Mini Cup Kit

- Kit includes:
- Two (2) cups and collars
 - Fifty (50) lids and liners
 - Twenty (20) plugs
 - Two (2) inserts
 - One (1) dispenser



Part Number	Quantity Per Case
051131- 16113	1

3M™ PPS™ Paint Preparation System Lids and Liners

- Contains lids, filters, liners and sealing caps.

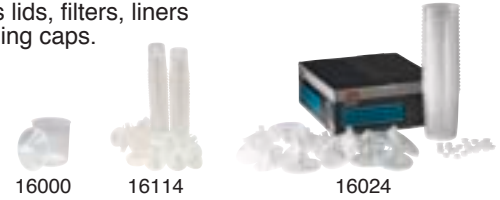

Part Number	Size	Items Per Box	Boxes Per Case
051131- 16000	Standard	50	1
051131- 16114	Mini	50	1
051131- 16024	Large	25	1

3M™ PPS™ Paint Preparation System Mixing Cups and Collars

- Cups that incorporate collars.





Part Number	Size	Cups Per Box	Boxes Per Case
051131- 16001	Standard	2	4
051131- 16115	Mini	2	4
051131- 16023	Large	1	4

*NOTE: 3M™ PPS™ Paint Preparation System part numbered items are available through authorized distributors. Please inquire with your distributor, contact your local 3M Sales Representative or contact 3M for availability.

3M™ PPS™ Paint Preparation System Adapters*







3M™ PPS™ Paint Preparation System Adapters (Packaged 4 Adapters per Box)

Part Number	3M™ PPS™ Adapter Number/Size	3M Spray Gun Type	Make & Model of Paint Gun
051131-16003 	#2 16mm Female 1.5mm Thread		ADIR
			Advantage #90115
		A, H	AES-150
		H	AirVerter GG-100 HVLP
		A, H	Astro, Astro M-Star
		A, H	ATD
		H	CA Technologies, Jaguar
		H	Campbell DH-7900 HVLP (Menards)
		H	Cent Neu HVLP
			Goni 321
		H	Husky HDS-790 HVLP (Home Depot)
		A, H	Ingersoll Rand 210 Gravity Feed
		H	Iwata LPA-94
		A	Iwata VXL-949 Primer Gun
		A	Iwata W-400
		A	Iwata WR-400, LPH-400
		H	M-Star
		H	Mac-Econocoat
		H	Matco
			MSB
			NESCO 840, 870
			Nikota HVLP-G
		A, H	Porter-Cable PSH-1, PSH-3
		A	Sata Jet-B
		H	Sata NR-92, NR-95
		H	Sharpe FX-200 Non-HVLP
		H	Sharpe FX-300 HVLP
			Spray-It 522
			Star-III
			Sunex, 9002A
	Trem Pro		
	Vaper 1.4mm Base/Clear Gun		
	Vaper 1.7mm Primer Gun		
H	Warwick, 861-C, 863, 881-C		
051131-16005 	#4 12mm Female 1.0mm Thread	A	Devilbiss Finishline (FLG-1), NTL-1261
051131-16006 	#5 12mm Male 1.5mm Thread		Defynik
		H	Sagola 403-G
		H	Sagola 4100-G, 4200-G
		H	Sagola 433-G
		H	Sagola 434-G
		H	Sagola 444-G
		H	Sagola 450-G
		A	Sata KL-Primer
			Sata MC-B-93 (Used with adapter taken off metal cup)

*NOTE: 3M™ PPS™ Paint Preparation System part numbered items are available through authorized distributors. Please inquire with your distributor, contact your local 3M Sales Representative or contact 3M for availability.

3M™ PPS™ Paint Preparation System Adapters*









3M™ PPS™ Paint Preparation System Adapters (Packaged 4 Adapters per Box)

Part Number	3M™ PPS™ Adapter Number/Size	3M Spray Gun Type	Make & Model of Paint Gun
051131-16007 	#6 1/4 Male 19 Thread (BSP)	H	Aerometal, Super Fura 34
		H	Aerometal, Victoria 92, 2015
		H	AirGunsa, AZ-3
			Asturo Gravity
		H	Eminent E13
		H	Iwata LPH-300
		A	Iwata W-300
051131-16008 	#7 3/8 Female 18 Thread (BSP)	H	AccuSpray, Issac
		H	Optima Gravity Feed Models: 500, 500i, 800, 800C, 800L, 800i
		H	TransStar-2
051131-16015 	#8 12mm Male 1.0mm Thread	H	GEO F/X (Walcom)
		H	Walcom GEO F/X
051131-16016 	#9 16mm Male 1.5mm Thread	H	AccuSpray, 05-100
		A	Sata Jet-90
		H	Sata KLC-B
		C	Sata KLC-RP
		H	Sata LM-2000
		H	Sata LM-92
		H	Sata MC-B Primer Gun
		H	Sata MC-B-90
		H	Sata NR-2000
			Sata QCC-Quick Cup Connector with Sata 96-719 QCC Adapter
		C	Sata RP-2000
051131-16017 	#10 Elbow Swivel Nut 1/4 Female 19 Thread (BSP)	H	Apollo A-8200, Side Cup Mount
			Devilbiss FUN, Gravity
		A	Devilbiss JGX-501, 502
		H	Devilbiss Touch-up Gun TGHV-635
		A	Graco 600 Side Cup Mount
		H	Iwata LPH-100, W-100G
		H	Iwata LPH-50 Mini Spray Gun
		A	Iwata RG3L Mini Air Brush
			Iwata W-71
			Meiji FSA Mini-Gun
051131-16018 	#11 3/8 Male 18 Thread (NPS)	H	Sharpe Cobalt HVLP (USA)
		H	Sharpe Platinum HVLP
		A	Sharpe SGF-98
		H	Sharpe Titanium T-1 HVLP
		H	Snap-On (Sharpe Cobalt)
051131-16022 	#12 10mm Male 1.0mm Thread	H	Sagola 475 Mini-Gun
		H	Sata Mini-Jet, Mini-Jet 4

*NOTE: 3M™ PPS™ Paint Preparation System part numbered items are available through authorized distributors. Please inquire with your distributor, contact your local 3M Sales Representative or contact 3M for availability.

3M™ PPS™ Paint Preparation System Adapters*





3M™ PPS™ Paint Preparation System Adapters (Packaged 4 Adapters per Box)

Part Number	3M™ PPS™ Adapter Number/Size	3M Spray Gun Type	Make & Model of Paint Gun
051131-16053 	#14 7/16 Male 14 Thread (UNC)	H	Binks Cub SLG, Mini-Gun
		H	Devilbiss Sri, Mini-Gun
051131-16046 	#15 3/8 Male 19 Thread (BSP)	H	Binks 1.8 MGI-Primer
		H	Binks 630 HVLP, 95-G
		H	Binks BBR-HVLP
		H	Binks M1-G
		A	Devilbiss Finishline-2
		H	Devilbiss Finishline-3
		A	Devilbiss GFG-5
		A	Devilbiss GFG-516, 517, GFG-618
		C	Devilbiss GFG-670 PLUS
		H	Devilbiss GFHV-510
		H	Devilbiss Gti Millennium, 620-G
		H	Ecco 652-S
		H	Graco Delta HVLP-GF
H	Sharpe Cobalt HVLP (Europe)		
051131-16102 	#16 3/8 Female 19 Thread (BSP)		Optima, All Gravity Feed Guns
			400, 500, 600, 700 and 800 Series
			All Siphon Feed Guns, Europe
051131-16111 	#17 1/4 Female 19 Thread (BSP)		Mini Siphon Guns, Europe
051131-16054 	#18 3/8 Female 18 Thread (NPS)	H	Devilbiss TGHV 530 Siphon Feed
		A, H, C	Siphon Feed, Full Size USA
051131-16103 	#19 3/8 Female 19 Thread (BSP)	A	Iwata W-200 Siphon
		A, H, C	Siphon Feed, Full Size Europe
051131-16104 	#20 1/8 Male 27 Thread (UPSM)	H	Sharpe MFG, MPF Mini-Gun HVLP
051131-16105 	#21 14mm Female 1.0mm Thread	H	AccuSpray Mini-Gun
		H	AirVerter CT-100 Mini Spray Gun
		H	Astro Star GF6S Mini-Gun HVLP
		A, H	ATD-6845 Mini-Gun
		H	Central Pneumatic Mini-Gun HVLP
		H	Cornwell PSG-1200 Mini-Gun
			Ingersoll Rand 200G
		H	Mac Mini-Gun HVLP
			Matco RL-75 Mini-Gun
		H	Mountain Star Mini
			NESCO 808 Mini
		A, H	Porter-Cable PSH2 Mini-Gun
		H	Sharpe FX-100 Mini HVLP
		H	Snap-On BF-325 Mini HVLP
		H	Vaper 1.0mm Mini-Jet Gun
H	Warwick 828-C, Mini HVLP		

*NOTE: 3M™ PPS™ Paint Preparation System part numbered items are available through authorized distributors. Please inquire with your distributor, contact your local 3M Sales Representative or contact 3M for availability.

3M™ PPS™ Paint Preparation System Adapters*

3M™ PPS™ Paint Preparation System Adapters (Packaged 4 Adapters per Box)

Part Number	3M™ PPS™ Adapter Number/Size	3M Spray Gun Type	Make & Model of Paint Gun
051131-16106 	#22 8mm Male .75mm Thread		Walcom Touch-up Gun STM HVLP
051131-16109 	#23 1/4 Female 1/8 Thread (NPS)		Balkamp (NAPA)
			Binks 115 Mini Siphon Feed
			Campbell Mini Siphon Feed
			Craftsman 9-15002
		A	Devilbiss EGA-503 Mini Siphon Feed
		H	Devilbiss Touch-up Gun EGHV-531
		A	Sharpe 555 Mini Siphon Gun
		H	Snap-On BF-400 Mini HVLP
		Snap-On BF-510 Detail	
051131-16110 	#24 Elbow Swivel Nut 1/4 Female 18 Thread (NPS)	H	Snap-On BF-515 Mini HVLP, Side Cup Mount
051131-16116 	#25 1/4 Female 19 Thread (BSP)	H	Devilbiss FUN, Siphon
		A	Iwata W-100, Siphon
			Kinky Creamy 88, Siphon (may be used as Siphon Feed Cup Mount)

*NOTE: 3M™ PPS™ Paint Preparation System part numbered items are available through authorized distributors. Please inquire with your distributor, contact your local 3M Sales Representative or contact 3M for availability.

3M™ PPS™ Paint Preparation System Inserts*

3M™ PPS™ Paint Preparation System Mylar Film Inserts



16061



16062



16064



16065



16066

Part Number	Size	Paint Company Specific Inserts	Inserts Per Box	Boxes Per Case
051131- 16055	Regular	PPG1	100	1
051131- 16056	Regular	PPG2	100	1
051131- 16057	Regular	BASF1	100	1
051131- 16058	Regular	BASF2	100	1
051131- 16059	Regular	BASF3	100	1
051131- 16060	Regular	DuPont	100	1
051131- 16061	Regular	SW1	100	1
051131- 16062	Regular	SW2	100	1
051131- 16064	Regular	Sikkens	100	1
051131- 16065	Regular	Generic	100	1
051131- 16066	Mini	Generic	50	1
051131- 16081	Large	PPG1	100	1
051131- 16082	Large	PPG2	100	1
051131- 16083	Large	BASF1	100	1
051131- 16084	Large	BASF2	100	1
051131- 16085	Large	BASF3	100	1
051131- 16086	Large	DuPont	100	1
051131- 16087	Large	SW1	100	1
051131- 16088	Large	SW2	100	1
051131- 16090	Large	Sikkens	100	1
051131- 16091	Large	Generic	100	1

3M™ PPS™ Paint Preparation System Accessories*

3M™ PPS™ Paint Preparation System Carrier

- Six-pack Paint Preparation System cup holder (with wall attachment hardware).



Part Number
051131-**16010**

Quantity
Per Case
1

3M™ PPS™ Paint Preparation System Lid Dispenser

- Lid dispenser.



Part Number
051131-**16099**

Quantity
Per Case
1

3M™ PPS™ Paint Preparation System Large Liner Dispenser

- Large liner dispenser.



Part Number
051131-**16019**

Quantity
Per Case
1

3M™ Detailing Squeeze Bottle

- Wash bottle for cleaning Paint Preparation System.



Part Number
051131-**37720**

Quantity
Per Case
24

*NOTE: 3M™ PPS™ Paint Preparation System part numbered items are available through authorized distributors. Please inquire with your distributor, contact your local 3M Sales Representative or contact 3M for availability.

3M™ PPS™ Paint Preparation System Spray Guns, Parts and Accessories*

(Please be sure to follow state and/or local regulations regarding spray gun selection and use.)

3M™ PPS™ Paint Preparation System Spray Guns

Kit contains one (1) each:

- Spray Gun
- Air Pressure Regulator (PN16229)
- Spray Gun Wrench & Packing Tool Kit (PN16224)
- Spray Gun Cleaning Brush Kit (PN16234)
- Lid and Liner
- Cup and Collar
- Spray Gun Manual
- Warranty Registration Card

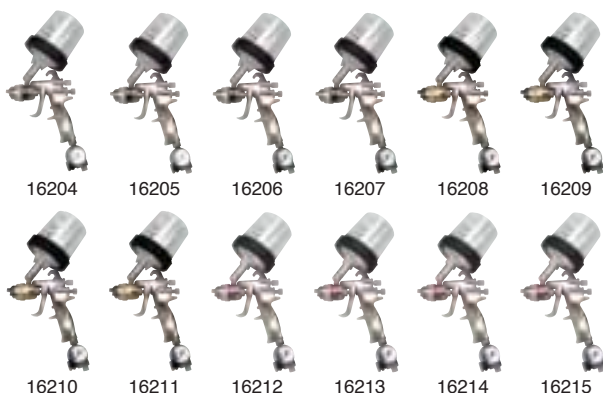

Part Number	Description	Quantity Per Case
051131-16204	3M™ PPS™ Paint Preparation System, 1 Air Spray Gun 1.3mm Kit	1
051131-16205	3M™ PPS™ Paint Preparation System, 1 Air Spray Gun 1.4mm Kit	1
051131-16206	3M™ PPS™ Paint Preparation System, 1 Air Spray Gun 1.5mm Kit	1
051131-16207	3M™ PPS™ Paint Preparation System, 1 Air Spray Gun 1.8mm Kit	1
051131-16208	3M™ PPS™ Paint Preparation System, 1 Compliant Spray Gun 1.3mm Kit	1
051131-16209	3M™ PPS™ Paint Preparation System, 1 Compliant Spray Gun 1.4mm Kit	1
051131-16210	3M™ PPS™ Paint Preparation System, 1 Compliant Spray Gun 1.5mm Kit	1
051131-16211	3M™ PPS™ Paint Preparation System, 1 Compliant Spray Gun 1.8mm Kit	1
051131-16212	3M™ PPS™ Paint Preparation System, 1 HVLP Spray Gun 1.3mm Kit	1
051131-16213	3M™ PPS™ Paint Preparation System, 1 HVLP Spray Gun 1.4mm Kit	1
051131-16214	3M™ PPS™ Paint Preparation System, 1 HVLP Spray Gun 1.5mm Kit	1
051131-16215	3M™ PPS™ Paint Preparation System, 1 HVLP Spray Gun 1.8mm Kit	1

3M™ PPS™ Paint Preparation System Spray Gun Parts and Accessories

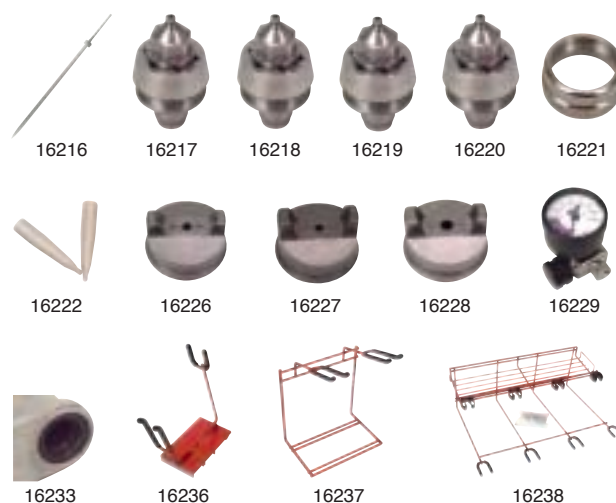

Part Number	Description	Quantity Per Case
051131-16216	Fluid Needle for Air Spray, Compliant and HVLP Spray Guns	1
051131-16217	1.3mm Fluid Nozzle for Air Spray, Compliant and HVLP Spray Guns	1
051131-16218	1.4mm Fluid Nozzle for Air Spray, Compliant and HVLP Spray Guns	1
051131-16219	1.5mm Fluid Nozzle for Air Spray, Compliant and HVLP Spray Guns	1
051131-16220	1.8mm Fluid Nozzle for Air Spray, Compliant and HVLP Spray Guns	1
051131-16221	Retaining Ring with Seal for Air Caps for Air Spray, Compliant and HVLP Spray Guns	1
051131-16222	PEEK Fluid Needle Tips	5
051131-16226	Air Cap for Air Spray Gun	1
051131-16227	Air Cap for Compliant Spray Gun	1
051131-16228	Air Cap for HVLP Spray Gun	1
051131-16229	Air Pressure Regulator	1
051131-16232	Paint Gun Lube	6
051131-16233	O-ring for Fluid Nozzle/Housing	6
051131-16235	Conventional Spray Gun Cup (Plastic)	1
051131-16236	"Single" 1-Gun Magnetic Spray Gun Holder	5
051131-16237	"Double" 2-Gun Bench Mount Spray Gun Holder	1
051131-16238	"Quad" 4-Gun Wall Mount Spray Gun Holder with PPS Cup Storage	1

*NOTE: 3M™ PPS™ Paint Preparation System Spray Guns, Parts and Accessories are available through authorized distributors. Please inquire with your distributor, contact your local 3M Sales Representative or contact 3M for availability.

3M™ PPS™ Paint Preparation System Spray Guns, Parts and Accessories*

(Please be sure to follow state and/or local regulations regarding spray gun selection and use.)

3M™ PPS™ Paint Preparation System Spray Gun Sales Demonstration Kit

Kit contains one (1) each:

- Compliant Spray Gun 1.3mm (PN16208)
- HVLP Spray Gun 1.4mm (PN16213)
- Air Pressure Regulator (PN16229)
- Fluid Nozzle 1.5mm (PN16219)
- Fluid Nozzle 1.8mm (PN16220)
- Air Spray, Air and Fluid Housing Assembly
- Air Spray, Fan Adjustment-Valve Assembly
- Air Spray, Air Cap (PN16226)
- Spray Gun Wrench (PN16224)
- Packing Installation Tool (PN16224)
- Spray Gun Cleaning Brush Kit (PN16234)
- Spray Gun Instruction Manual
- Demonstration Case

Part Number	Quantity Per Case
051131- 16223	1

3M™ PPS™ Paint Preparation System Spray Gun Wrench & Packing Installation Tool Kit

Kit contains one (1) each:

- Spray Gun Wrench (28)
- Packing Installation Tool (29)

Part Number	Quantity Per Case
051131- 16224	1

3M™ PPS™ Paint Preparation System Rebuild Packing Seals and Spring Kit

Kit contains four (4) each:

- Valve Packing Nut

Kit contains one (1) each:

- Spring (22)
- Spring (23)
- Air Valve Assembly (26)
- U-Cup Packing (Gun)
- U-Cup Spreader (Fluid)
- U-Cup Packing (Fluid)
- U-Cup Spacer (Fluid)
- U-Cup Packing (Retainer)
- O-Ring Packing (2b)
- O-Ring Packing (34)
- Instruction Manual



Part Number	Quantity Per Case
051131- 16230	1

3M™ PPS™ Paint Preparation System HVLP Air Pressure Verification Kit

Kit contains one (1) each:

- Air Pressure Gauge 0–15 PSI
- Nylon Hose for connecting Pressure Gauge to HVLP Test Air Cap
- HVLP Test Air Cap
- Retaining Ring with Seal for Air Cap (PN16221)



Part Number	Quantity Per Case
051131- 16231	1

3M™ PPS™ Paint Preparation System Spray Gun Cleaning Brush Kit

Kit contains one (1) each:

- 0.062" Mini Twist Brush
- 0.5" Nylon Interior Cavity Brush
- 0.25" Nylon HVLP Brush
- Nylon Bristle Exterior Body Brush

Part Number	Quantity Per Case
051131- 16234	1

*NOTE: 3M™ PPS™ Paint Preparation System Spray Guns, Parts and Accessories are available through authorized distributors. Please inquire with your distributor, contact your local 3M Sales Representative or contact 3M for availability.

Abrasives



Products

3M Abrasive Accessories	42-60
Quick Reference Chart	42-43
3M Abrasives	15-41

3M Performance Class Abrasives (Discs, Disc Rolls, Sheets)	18-23
Quick Reference Chart	18-19
3M [™] Imperial [™] Abrasives	20-23
Hookit [™] II	20, 22
Stikit [™]	21, 23
Dry	21
Dust-Free	20, 22-23
Fibre	20
3M [™] Trizact [™] Hookit [™] II Abrasives	23

3M Standard Class Abrasives (Cut-Off Wheels, Discs, Disc Rolls, Sheets)	24-29
Quick Reference Chart	24-25
3M [™] Green Corps [™] Abrasives	26-29
Hookit [™] Regalite [™]	26
Stikit [™] Production [™]	27
Roloc [™]	29
Dry Production [™]	28
Dust-Free	26-28
Fibre	29
3M [™] Stikit [™] Green Fre-Cut [™] Abrasives	28
Dust-Free	28

3M Standard Class Abrasives (Discs, Disc Rolls, Film, Finishing Film, Sheets, Sheet Rolls)	30-35
Quick Reference Chart	30-31
3M [™] Hookit [™] Gold Abrasives	32
Dust-Free	32
3M [™] Hookit [™]	35
Dust-Free	35
3M [™] Stikit [™] Gold and Stikit [™] Production [™]	32-33
Gold Abrasives	32-33
Dust-Free	33
3M [™] Stikit [™]	34-35
Gold Dry	34

3M Utility Class Abrasives (Cut-Off Wheels, Discs, Disc Rolls, Sheets, Paper Sheets, Sponge Sheets)	36-39
Quick Reference Chart	36
3M [™] Stikit [™] Production [™]	38
3M [™] Stikit [™] Tri-M-ite [™] Fre-Cut [™]	39
3M [™] Tri-M-ite [™] Fre-Cut [™]	39
3M [™] Tri-M-ite [™] Resin Bond	38
3M [™] Production [™]	38

3M[™] Wetordry[™] Abrasives (Discs, Paper Sheets)	40-41
Quick Reference Chart	40
3M [™] Imperial [™]	41
3M [™] Finesse-It [™] Imperial [™]	41
3M [™] Tri-M-ite [™]	41

3M Job-Packed Abrasives and Accessories	61-64
3M Retail Abrasives and Accessories	65-66

Abrasives



Introduction to Abrasives

3M Abrasives Products Guide

3M abrasive products in this catalog have been divided into four groups; a “Quick Reference Chart” exists for each group. See example below.

- **3M Performance Class Abrasives** are shown on the purple chart (pages 18 and 19) and subsequent descriptive pages. These are our **Best** performing products. They offer the user the highest performance in rate of cut as well as durability and long life. 3M Performance Class Abrasives maximize shop and user productivity by employing state of the art technology in coated abrasives.
- **3M Standard Class Abrasives** are shown on the green and gold charts (pages 24, 25, 30 and 31) and the subsequent descriptive pages after each chart. These are our **Better** performing products and offer excellent performance and productivity for shops and users. Very good durability, long life and established acceptance by the industry are characteristics of the 3M Standard Class Abrasives.
- **3M Utility Class Abrasives** are shown on the gray chart (page 36) and the subsequent descriptive pages. These abrasive products are our **Good** performing products and offer a long-established level of performance that certain users have depended on and still desire.
- **3M™ Wetordry™ Abrasives** are shown on the black chart (page 40) and the subsequent descriptive pages. 3M was the originator of 3M™ Wetordry™ abrasive sheets and remains a leader in the manufacture of both silicon carbide and aluminum oxide mineral based wet sanding abrasives.

3M Abrasive Accessories

A chart of accessories for use with the above-mentioned abrasive products is on pages 42–43 and subsequent descriptive pages follow.

Reading the Charts

It is simple if you first look across the top of each column and find the type of product and the size that you want. It is important to completely read the column description so that you are sure of what item is represented in the column.

2-3/4" X 16-1/2" 3M™ Imperial™ Hookit™ II Sheets, E Wt. 25/Box 4 Boxes/Case	2-3/4" X 16" 3M™ Imperial™ Hookit™ II Sheets, E Wt. Dust-Free 25/Box 4 Boxes/Case	2-3/4" X 16-1/2" 3M™ Imperial™ Stikit™ Sheets, E Wt. 50/Box 4 Boxes/Case	2-3/4" X 17-1/2" 3M™ Imperial™ Dry Sheets, E Wt. 50/Box 4 Boxes/Case	continued below on page 18
				P1500
				P1200
				P1000
				P800
				P600
				P500
				P400
				P360
				P320
				P280
				P240
				P220
				P180
				P150
00799		00389	02254	P120
00800	00729	00390		P100
00801	00730	00391	02256	P80
				P60
				P50
00802	00731	00393	02258	P40
00803	00732	00394	02259	P36
				P24

Chart example from page19.

As an example, if you are looking for 2-3/4" x 16" 3M™ Imperial™ Hookit™ II Sheets, you need to read the complete description, because you may or may not require Dust-Free Sheets. This example is on page 19, the third column from the far right. Once you find the column that describes the product you want, you need to know if 3M offers it in the abrasive grade (grit) that you also want. Read down the column and match with the grade numbers that are on the right and left sides of the charts. Where you see a five-digit part number at the intersection of the Abrasive Description and the Abrasive Grade number, it indicates that the type of abrasive product is available in the grade desired. Going back to our example on page 19, we can see that the 2-3/4" x 16" Imperial™ Hookit™ II Sheets, E Weight, Dust-Free are available in grade P100 (PN00729) but not available in Grade P120, where no five-digit part number appears.

3M Performance Class Abrasives

	5" 3M™ Imperial™ Fibre Discs 10/Box 5 Boxes/Case	7" 3M™ Imperial™ Fibre Discs 10/Box 5 Boxes/Case	5" 3M™ Imperial™ Hookit™ II Discs, E Wt. 25/Box 4 Boxes/Case	5" 3M™ Imperial™ Stikit™ Discs, E Wt. 50/Box 4 Boxes/Case	6" 3M™ Imperial™ Hookit™ II Discs, E Wt. 25/Box 4 Boxes/Case	6" 3M™ Imperial™ Hookit™ II Discs, E Wt. Dust-Free 25/Box 4 Boxes/Case	6" 3M™ Imperial™ Stikit™ Discs, E Wt. 50/Box 4 Boxes/Case	
P3000								
P1500								
P1200								
P1000								
P800								
P600								
P500								
P400								
P360								
P320								
P280								
P240								
P220								
P180								
P150								
P120								
P100								
P80			00828		00833	00786	00371*	
60								
50	01943	01951						
40			00829	00367	00834	00787	00373	
36	01944	01952		00368	00835		00374	
24	01945	01953						

*100 Per Roll

continued from page 61	3" 3M™ Imperial™ Hookit™ II Discs 50/Box 4 Boxes/Case	5" 3M™ Imperial™ Hookit™ II Discs 50/Box 4 Boxes/Case	5" 3M™ Imperial™ Stikit™ Disc Rolls 75/Roll 4 Rolls/Case	6" 3M™ Imperial™ Hookit™ II Discs 50/Box 4 Boxes/Case	6" 3M™ Imperial™ Hookit™ II Discs, Dust-Free 50/Box 4 Boxes/Case	6" 3M™ Imperial™ Stikit™ Disc Rolls 75/Roll 4 Rolls/Case	6" 3M™ Imperial™ Stikit™ Disc Rolls, Dust-Free 100/Roll 4 Rolls/Case	8" 3M™ Imperial™ Hookit™ II Discs 25/Box 4 Boxes/Case	
P3000									
P1500									
P1200									
P1000									
P800									
P600									
P500	00712	00656	00298	00672	00772	00322	00417		
P400	00713	00657	00299	00673	00773	00323	00418		
P360		00658		00674	00774	00324			
P320	00714	00659	00301	00675	00775	00325	00420		
P280			00302	00676	00776	00326			
P240		00661	00303	00677		00327	00422		
P220	00716	00662	00304	00678	00778	00328	00423	00685	
P180	00717	00663		00679	00779	00329	00424	00686	
P150	00718	00664	00306	00680	00780	00330	00425	00687	
P120	00719	00665	00307	00681	00781	00331		00688	
P100	00720	00666		00682	00782	00332			
P80	00721	00667	00309	00683	00783	00333	00428	00690	
60									
50									
40									
36									
24									

3M Performance Class Abrasives

	8" 3M™ Imperial™ Hookit™ II Discs, E Wt. 25/Box 4 Boxes/Case	8" 3M™ Imperial™ Hookit™ II Discs, E Wt. Dust-Free 25/Box 4 Boxes/Case	8" 3M™ Imperial™ Stikit™ Discs, E Wt. 25/Box 4 Boxes/Case	2 3/4" X 16 1/2" 3M™ Imperial™ Hookit™ II Sheets, E Wt. 25/Box 4 Boxes/Case	2 3/4" X 16" 3M™ Imperial™ Hookit™ II Sheets, E Wt. Dust-Free 25/Box 4 Boxes/Case	2 3/4" X 16 1/2" 3M™ Imperial™ Stikit™ Sheets, E Wt. 50/Box 4 Boxes/Case	2 3/4" X 17 1/2" 3M™ Imperial™ Dry Sheets, E Wt. 50/Box 4 Boxes/Case	continued below on page 18
								P3000
								P1500
								P1200
								P1000
								P800
								P600
								P500
								P400
								P360
								P320
								P280
								P240
								P220
								P180
								P150
		00789		00799		00389	02254	P120
				00800	00729	00390		P100
	00843	00791	00377	00801	00730	00391	02256	P80
								P60
								P50
	00844	00792	00379	00802	00731	00393	02258	P40
	00845	00793	00380	00803	00732	00394	02259	P36
								P24

	2 3/4" X 16 1/2" 3M™ Imperial™ Hookit™ II Sheets 25/Box 4 Boxes/Case	3" 3M™ Imperial™ Hookit™ II Finishing Film Discs 50/Box 4 Boxes/Case	5" 3M™ Hookit™ II Finishing Film Discs 50/Box 4 Boxes/Case	6" 3M™ Hookit™ II Finishing Film Discs 50/Box 4 Boxes/Case	6" 3M™ Hookit™ II Finishing Film Discs, Dust-Free 50/Box 4 Boxes/Case	3" 3M™ Trizact™ Hookit™ II Foam Disc 15/Box 4 Boxes/Case	6" 3M™ Trizact™ Hookit™ II Foam Disc 15/Box 4 Boxes/Case	
						02077	02075	P3000
		00707	00851	00850	00750			P1500
		00708	00852	00868	00768			P1200
		00709	00853	00869	00769			P1000
		00710	00854	00870	00770			P800
		00711	00855	00871	00771			P600
								P500
								P400
								P360
								P320
								P280
								P240
	02669							P220
	02670							P180
	02672							P150
	02673							P120
								P100
								P80
								P60
								P50
								P40
								P36
								P24

3M Performance Class Abrasives

3M™ Imperial™ Fibre Discs

- High-performance grinding discs.
- New, high-performance mineral.
- Durable, long lasting, fast cutting.
- Use for door skinning, grinding MIG welds or any kind of metal grinding.

Part Number	Grade	For Use with Disc/ Backup Pad	Discs Per Box	Boxes Per Case
5" Diameter				
051131-01943	50	PN05637	10	5
051131-01944	36	PN05637	10	5
051131-01945	24	PN05637	10	5
7" Diameter				
051131-01951	50	PN05634	10	5
051131-01952	36	PN05634	10	5
051131-01953	24	PN05634	10	5

3M™ Imperial™ Hookit™ II Discs/Sheets (E Weight)

- Purple in color.
- Best performing abrasive products.
- Uniquely blended mineral.
- Tough "E" weight backing.
- Fast-cutting, long-lasting.
- Excellent for stripping paint or sanding plastic filler.
- Hookit™ II attachment system: The stems, or hooks, are on the back of the abrasive and the loops are on the front of the accessory.
- See pages 42, 44, 47, 48, 50 and 51 for proper backup pad selection.

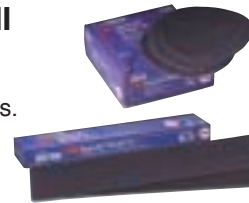

Part Number	Grade	Discs Per Box	Boxes Per Case
5" Diameter			
051131-00828	P80E	25	4
051131-00829	40E	25	4
6" Diameter			
051131-00833	P80E	25	4
051131-00834	40E	25	4
051131-00835	36E	25	4
8" Diameter			
051131-00843	P80E	25	4
051131-00844	40E	25	4
051131-00845	36E	25	4

Part Number	Grade	Sheets Per Box	Boxes Per Case
2-3/4" x 16-1/2"			
051131-00799	P120E	25	4
051131-00800	P100E	25	4
051131-00801	P80E	25	4
051131-00802	40E	25	4
051131-00803	36E	25	4



Part Number	Grade	Discs Per Box	Boxes Per Case
6" Diameter			
051131-00786*	P80E	25	4
051131-00787*	40E	25	4
8" Diameter			
051131-00789*	P120E	25	4
051131-00791*	P80E	25	4
051131-00792*	40E	25	4
051131-00793*	36E	25	4

*Dust-free products are prepunched with a standard hole pattern for dust-free sanding.

Part Number	Grade	Sheets Per Box	Boxes Per Case
2-3/4" x 16"			
051131-00729*	P100E	25	4
051131-00730*	P80E	25	4
051131-00731*	40E	25	4
051131-00732*	36E	25	4

*Dust-free products are prepunched with a standard hole pattern for dust-free sanding.

3M Performance Class Abrasives

3M™ Imperial™ Stikit™ Discs/Sheets (E Weight)

- Purple in color.
- Uniquely blended mineral.
- Tough "E" weight backing.
- Fast-cutting, long-lasting
- Excellent for stripping paint or sanding plastic filler.
- Pressure-sensitive adhesive (PSA) backing.
- See pages 42, 44, 47, 48, 50 and 51 for proper backup pad selection.



Part Number	Grade	Discs Per Box	Boxes Per Case
5" Diameter			
051131-00367	40E	50	4
051131-00368	36E	50	4

Part Number	Grade	Discs Per Box	Boxes Per Case
6" Diameter			
051131-00371	P80E	100	4
051131-00373	40E	50	4
051131-00374	36E	50	4
8" Diameter			
051131-00377	P80E	25	4
051131-00379	40E	25	4
051131-00380	36E	25	4

Part Number	Grade	Sheets Per Box	Boxes Per Case
2-3/4" x 16-1/2"			
051131-00389	P120E	50	4
051131-00390	P100E	50	4
051131-00391	P80E	50	4
051131-00393	40E	50	4
051131-00394	36E	50	4

3M™ Imperial™ Dry Sheets (E Weight)

- Purple in color.
- Uniquely blended mineral.
- Tough "E" weight backing.
- Fast-cutting, long-lasting.
- Excellent for stripping paint or sanding plastic filler.



Part Number	Grade	Sheets Per Box	Boxes Per Case
2-3/4" x 17-1/2"			
051131-02254	P120E	50	4
051131-02256	P80E	50	4
051131-02258	40E	50	4
051131-02259	36E	50	4

3M Performance Class Abrasives

3M™ Imperial™ Hookit™ II Discs/Sheets (A Weight, C Weight)

- Purple in color.
- Best performing abrasive products.
- Long-lasting abrasive construction of the Imperial™ product line enables the user to obtain maximum usage of each disc.
- Hookit™ II attachment system: The stems, or hooks, are on the back of the abrasive and the loops are on the front of the accessory.
- See pages 42–53 for proper backup pad selection.

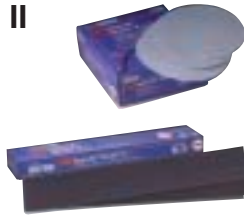

Part Number	Grade	Discs Per Box	Boxes Per Case
3" Diameter			
051131-00712	P500	50	4
051131-00713	P400	50	4
051131-00714	P320	50	4
051131-00716	P220	50	4
051131-00717	P180	50	4
051131-00718	P150	50	4
051131-00719	P120	50	4
051131-00720	P100	50	4
051131-00721	P80	50	4
5" Diameter			
051131-00656	P500	50	4
051131-00657	P400	50	4
051131-00658	P360	50	4
051131-00659	P320	50	4
051131-00661	P240	50	4
051131-00662	P220	50	4
051131-00663	P180	50	4
051131-00664	P150	50	4
051131-00665	P120	50	4
051131-00666	P100	50	4
051131-00667	P80	50	4
6" Diameter			
051131-00672	P500	50	4
051131-00673	P400	50	4
051131-00674	P360	50	4
051131-00675	P320	50	4
051131-00676	P280	50	4
051131-00677	P240	50	4
051131-00678	P220	50	4
051131-00679	P180	50	4
051131-00680	P150	50	4
051131-00681	P120	50	4
051131-00682	P100	50	4
051131-00683	P80	50	4

3M™ Imperial™ Hookit™ II Discs/Sheets (A Weight, C Weight) (continued)

Part Number	Grade	Discs Per Box	Boxes Per Case
8" Diameter			
051131-00685	P220	25	4
051131-00686	P180	25	4
051131-00687	P150	25	4
051131-00688	P120	25	4
051131-00690	P80	25	4

Part Number	Grade	Sheets Per Box	Boxes Per Case
2-3/4" x 16-1/2"			
051131-02669	P220	25	4
051131-02670	P180	25	4
051131-02672	P150	25	4
051131-02673	P120	25	4



Part Number	Grade	Discs Per Box	Boxes Per Case
6" Diameter			
051131-00772*	P500	50	4
051131-00773*	P400	50	4
051131-00774*	P360	50	4
051131-00775*	P320	50	4
051131-00776*	P280	50	4
051131-00778*	P220	50	4
051131-00779*	P180	50	4
051131-00780*	P150	50	4
051131-00781*	P120	50	4
051131-00782*	P100	50	4
051131-00783*	P80	50	4

*Dust-free products are prepunched with a standard hole pattern for dust-free sanding.

3M Performance Class Abrasives

3M™ Imperial™ Stikit™ Disc Rolls (A Weight, C Weight)

- Purple in color.
- Best performing abrasive products.
- Long-lasting abrasive construction of the Imperial™ product line enables the user to obtain maximum usage of each disc.
- Pressure-sensitive adhesive (PSA) backing.
- See pages 42, 44, 45 and 53 for proper backup pad selection.



Part Number	Grade	Discs Per Roll	Rolls Per Case
5" Diameter			
051131-00298	P500	75	4
051131-00299	P400	75	4
051131-00301	P320	75	4
051131-00302	P280	75	4
051131-00303	P240	75	4
051131-00304	P220	75	4
051131-00306	P150	75	4
051131-00307	P120	75	4
051131-00309	P80	75	4
6" Diameter			
051131-00322	P500	75	4
051131-00323	P400	75	4
051131-00324	P360	75	4
051131-00325	P320	75	4
051131-00326	P280	75	4
051131-00327	P240	75	4
051131-00328	P220	75	4
051131-00329	P180	75	4
051131-00330	P150	75	4
051131-00331	P120	75	4
051131-00332	P100	75	4
051131-00333	P80	75	4



Part Number	Grade	Discs Per Roll	Rolls Per Case
6" Diameter			
051131-00417*	P500	100	4
051131-00418*	P400	100	4
051131-00420*	P320	100	4
051131-00422*	P240	100	4
051131-00423*	P220	100	4
051131-00424*	P180	100	4
051131-00425*	P150	100	4
051131-00428*	P80	100	4

*Dust-free products are prepunched with a standard hole pattern for dust-free sanding.

3M™ Imperial™ Hookit™ II Finishing Film Discs

- High performing aluminum oxide.
- Cuts fast, lasts long, resists loading and leaves a consistent finish.
- For use in scuff sanding before painting.
- Use to remove runs, dust nibs and excess orange peel from topcoat finishes.
- Hookit™ II attachment system: The stems, or hooks, are on the back of the abrasive and the loops are on the front of the accessory.
- See pages 42, 44, 47, 48, 51 and 53 for proper backup pad selection.



Part Number	Grade	Discs Per Box	Boxes Per Case
3" Diameter			
051131-00707	P1500	50	4
051131-00708	P1200	50	4
051131-00709	P1000	50	4
051131-00710	P800	50	4
051131-00711	P600	50	4
5" Diameter			
051131-00851	P1500	50	4
051131-00852	P1200	50	4
051131-00853	P1000	50	4
051131-00854	P800	50	4
051131-00855	P600	50	4
6" Diameter			
051131-00850	P1500	50	4
051131-00868	P1200	50	4
051131-00869	P1000	50	4
051131-00870	P800	50	4
051131-00871	P600	50	4

Part Number	Grade	Discs Per Box	Boxes Per Case
6" Diameter			
051131-00750*	P1500	50	4
051131-00768*	P1200	50	4
051131-00769*	P1000	50	4
051131-00770*	P800	50	4
051131-00771*	P600	50	4

*Dust-free products are prepunched with a standard hole pattern for dust-free sanding.

3M™ Trizact™ Hookit™ II Foam Discs

- Trizact™ abrasive features a pyramid-shaped structure that contains multiple layers of abrasive mineral.
- Provides a consistently smooth finish.
- Use to refine Finishing Film scratches.
- Hookit™ II attachment system: The stems, or hooks, are on the back of the abrasive and the loops are on the front of the accessory.
- See pages 42, 44, 47, 48 and 52 for proper backup pad selection.



Part Number	Size	Discs Per Box	Boxes Per Case
051131-02077	3"	15	4
051131-02075	6"	15	4

3M Standard Class Abrasives

	5" X 7/8" 3M™ Green Corps™ Fibre Discs 20/Box 5 Boxes/Case	7" X 7/8" 3M™ Green Corps™ Fibre Discs 20/Box 5 Boxes/Case	9 1/8" X 7/8" 3M™ Green Corps™ Fibre Discs 20/Box 5 Boxes/Case	2" 3M™ Green Corps™ Roloc™ Discs 25/Box 10 Boxes/Case	3" 3M™ Green Corps™ Roloc™ Discs 25/Box 10 Boxes/Case	5" 3M™ Green Corps™ Stikit™ Production™ Discs, E Wt. 100/Box 5 Boxes/Case	5" 3M™ Green Corps™ Stikit™ Production™ Discs, E Wt. Dust-Free 100/Box 5 Boxes/Case	
100								
80								
60								
50	01913	01921	01927	01396	01406			
40						01545	01665	
36	01914	01922	01928	01397	01407	01546		
24	01915	01923	01929	01398	01408			
16	01916	01924	01930					

Size based on page on page on page	8" 3M™ Green Corps™ Stikit™ Production™ Discs, E Wt. Dust-Free 50/Box 5 Boxes/Case	2 1/4" X 16 1/2" 3M™ Green Corps™ Hookit™ Regalite™ Sheets, E Wt. 50/Box 5 Boxes/Case	2 1/4" X 16" 3M™ Green Corps™ Hookit™ Regalite™ Sheets, E Wt. Dust-Free 50/Box 5 Boxes/Case	2 1/4" X 16 1/2" 3M™ Green Corps™ Stikit™ Production™ Sheets, E Wt. 100/Box 5 Boxes/Case	2 1/4" X 16" 3M™ Green Corps™ Stikit™ Production™ Sheets, E Wt. Dust-Free 100/Box 5 Boxes/Case	2 1/4" X 17 1/2" 3M™ Green Corps™ Production™ Resin Paper Sheets, E Wt. 100/Box 5 Boxes/Case	3 1/2" X 9" 3M™ Green Corps™ Production™ Resin Paper Sheets, E Wt. 100/Box 10 Boxes/Case	
	100		00538					
80	01569*, 01579*	00539	00639	02230*	02260*	02220*	02225*	
60		00540						
50								
40	01660, 01670	00542	00642	02231	02261	02221	02226	
36	01661	00543		02232	02262	02222	02227	
24								
16								

*3M™ Fre-Cut™ Disc,
D Wt.

*3M™ Fre-Cut™ Sheet,
D Wt.

*3M™ Fre-Cut™ Sheet,
D Wt.

*3M™ Fre-Cut™ Sheet,
D Wt.

*3M™ Fre-Cut™ Sheet,
D Wt.

3M Standard Class Abrasives

	6" 3M™ Green Corps™ Hookit™ Regalite™ Discs, E Wt. 25/Box 5 Boxes/Case	6" 3M™ Green Corps™ Hookit™ Regalite™ Discs, E Wt. Dust-Free 25/Box 5 Boxes/Case	6" 3M™ Green Corps™ Stikit™ Production™ Discs, E Wt. 100/Box 5 Boxes/Case	6" 3M™ Green Corps™ Stikit™ Production™ Discs, E Wt. Dust-Free 100/Box 5 Boxes/Case	8" 3M™ Green Corps™ Hookit™ Regalite™ Discs, E Wt. 25/Box 5 Boxes/Case	8" 3M™ Green Corps™ Hookit™ Regalite™ Discs, E Wt. Dust-Free 25/Box 5 Boxes/Case	8" 3M™ Green Corps™ Stikit™ Production™ Discs, E Wt. 50/Box 5 Boxes/Case	continued below on page 24
					00520			100
	00512	00612			00521	00621	01549*	80
	00513				00522			60
								50
	00515	00615	01547	01667	00524	00624	01550	40
	00516	00616	01548	01668	00525	00625	01551	36
								24
								16

*3M™ Fre-Cut™ Disc,
D Wt.

	5" 3M™ Stikit™ Green Fre-Cut™ Disc Rolls 100/Roll 10 Rolls/Case	5" 3M™ Stikit™ Green Fre-Cut™ Disc Rolls, Dust-Free 100/Roll 10 Rolls/Case	6" 3M™ Stikit™ Green Fre-Cut™ Disc Rolls 100/Roll 10 Rolls/Case	6" 3M™ Stikit™ Green Fre-Cut™ Disc Rolls, Dust-Free 100/Roll 10 Rolls/Case	3" X ½" X ¾" 3M™ Green Corps™ Cut-Off Wheel	3" X ¼" X ¾" 3M™ Green Corps™ Cut-Off Wheel	3" X ⅛" X ¾" 3M™ Green Corps™ Reinforced Weld Grinding Wheel	
					01989**	01990**	01991**	
	01501	01561	01506	01566				100
								80
								60
								50
								40
								36
								24
								16

**No Grade

**No Grade

**No Grade

3M Standard Class Abrasives

3M™ Green Corps™ Hookit™ Regalite™ Discs/Sheets (E Weight)

- Uniquely blended mineral.
- Tough “E” weight backing.
- Fast-cutting, long-lasting.
- Excellent for stripping paint or sanding plastic filler.
- Hook-and-Loop attachment system.
- See pages 42, 44, 49, 50 and 51 for proper backup pad selection.



Part Number	Grade	Discs Per Box	Boxes Per Case
6" Diameter			
051131-00512	80E	25	5
051131-00513	60E	25	5
051131-00515	40E	25	5
051131-00516	36E	25	5
8" Diameter			
051131-00520	100E	25	5
051131-00521	80E	25	5
051131-00522	60E	25	5
051131-00524	40E	25	5
051131-00525	36E	25	5

Part Number	Grade	Sheets Per Box	Boxes Per Case
2-3/4" x 16-1/2"			
051131-00538	100E	50	5
051131-00539	80E	50	5
051131-00540	60E	50	5
051131-00542	40E	50	5
051131-00543	36E	50	5

3M™ Green Corps™ Hookit™ Regalite™ Discs/Sheets (E Weight) (continued)

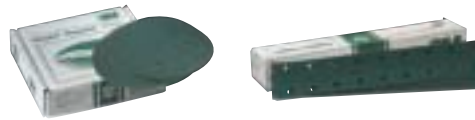

Part Number	Grade	Discs Per Box	Boxes Per Case
6" Diameter			
051131-00612*	80E	25	5
051131-00615*	40E	25	5
051131-00616*	36E	25	5
8" Diameter			
051131-00621*	80E	25	5
051131-00624*	40E	25	5
051131-00625*	36E	25	5

Part Number	Grade	Sheets Per Box	Boxes Per Case
2-3/4" x 16"			
051131-00639*	80E	50	5
051131-00642*	40E	50	5

*Dust-free products are prepunched with a standard hole pattern for dust-free sanding.

3M Standard Class Abrasives

3M™ Green Corps™ Stikit™ Production™ Disc/Sheets (E Weight)

- Tough mineral/bond construction.
- Tough "E" weight backing.
- Fast-cutting, long-lasting.
- Excellent for stripping paint or sanding plastic filler.
- Pressure-sensitive adhesive (PSA) backing.
- See pages 42, 44, 45 and 46 for proper backup pad selection.



Part Number	Grade	Discs Per Box	Boxes Per Case
5" Diameter			
051131-01545	40E	100	5
051131-01546	36E	100	5
6" Diameter			
051131-01547	40E	100	5
051131-01548	36E	100	5
8" Diameter			
051131-01549 †	80D	50	5
051131-01550	40E	50	5
051131-01551	36E	50	5

† 3M™ Fre-Cut™ Disc, D Weight

Part Number	Grade	Sheets Per Box	Boxes Per Case
2-3/4" x 16-1/2"			
051131-02230 †	80D	100	5
051144-02231	40E	100	5
051144-02232	36E	100	5

† 3M™ Fre-Cut™ Sheet, D Weight

3M™ Green Corps™ Stikit™ Production™ Disc/Sheets (E Weight) (continued)

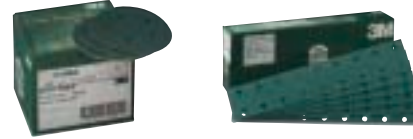

Part Number	Grade	Discs Per Box	Boxes Per Case
5" Diameter — 8 Hole			
051131-01665*	40E	100	5
6" Diameter — 8 Hole			
051131-01667*	40E	100	5
051131-01668*	36E	100	5
8" Diameter — 8 Hole			
051131-01569* †	80D	50	5
051131-01660*	40E	50	5
051131-01661*	36E	50	5
8" Diameter — 12 Hole			
051131-01579* †	80D	50	5
051131-01670*	40E	50	5

*Dust-free products are prepunched with a standard hole pattern for dust-free sanding.

† 3M™ Fre-Cut™ Disc, D Weight

Part Number	Grade	Sheets Per Box	Boxes Per Case
2-3/4" x 16"			
051131-02260* †	80D	100	5
051131-02261*	40E	100	5
051131-02262*	36E	100	5

*Dust-free products are prepunched with a standard hole pattern for dust-free sanding.

† 3M™ Fre-Cut™ Sheet, D Weight

3M Standard Class Abrasives

3M™ Green Corps™ Dry Production™ Sheets (E Weight)

- Tough mineral/bond construction.
- Tough “E” weight backing.
- Fast-cutting, long-lasting.
- Excellent for stripping paint or sanding plastic filler.



Part Number	Grade	Sheets Per Box	Boxes Per Case
2-3/4" x 17-1/2"			
051131-02220 †	80D	100	5
051144-02221	40E	100	5
051144-02222	36E	100	5

† 3M™ Fre-Cut™ Sheets, D Weight

Part Number	Grade	Sheets Per Box	Boxes Per Case
3-2/3" x 9"			
051131-02225 †	80D	100	10
051131-02226	40E	100	10
051131-02227	36E	100	10

† 3M™ Fre-Cut™ Sheets, D Weight

3M™ Stikit™ Green Fre-Cut™ Disc Rolls

- Durable and long lasting disc product.
- Comes in roll form for easy dispensing.
- Pressure-sensitive adhesive (PSA) backing.
- See pages 42, 44 and 45 for proper backup pad selection.



Part Number	Grade	Discs Per Roll	Rolls Per Case
5" Diameter			
051144-01501	80D	100	10
6" Diameter			
051144-01506	80D	100	10



Part Number	Grade	Discs Per Roll	Rolls Per Case
5" Diameter			
051131-01561*	80D	100	10
6" Diameter			
051131-01566*	80D	100	10

*Dust-free products are prepunched with a standard hole pattern for dust-free sanding. See pages 42 and 53 for proper backup pad selection.

3M Standard Class Abrasives

3M™ Green Corps™ Cut-Off/Reinforced Weld Grinding Wheels

- Used for cutting auto body sheet metal, frame rails, clamps and rusted bolts.
- Weld grinding wheel ideal for cutting spot welds and grinding in hard-to-reach places.
- For use on utility type cut-off tools.

**NOTE: Read all warnings supplied with wheels.
DO NOT use on tool without guards.**



Part Number	Size	Wheels Per Pack	Packs Per Case
051131-01989	3" x 1/32" x 3/8"	5	10
051131-01990	3" x 1/16" x 3/8"	5	10
051131-01991	3" x 3/16" x 3/8"	5	10

3M™ Green Corps™ Fibre Discs

- All-purpose grinding discs for door skinning, grinding MIG welds or any kind of metal grinding.
- High-performance grinding discs.
- Long-lasting and fast-cutting.
- See pages 43 and 54 for proper backup pad selection.



Part Number	Grade	For Use with Disc/ Backup Pad	Discs Per Box	Boxes Per Case
5" x 7/8"				
051131-01913	50	PN05637	20	5
051131-01914	36	PN05637	20	5
051144-01915	24	PN05637	20	5
051131-01916	16	PN05637	20	5
7" x 7/8"				
051131-01921	50	PN05634	20	5
051131-01922	36	PN05634	20	5
051144-01923	24	PN05634	20	5
051131-01924	16	PN05634	20	5
9-1/8" x 7/8"				
051131-01927	50	—	20	5
051131-01928	36	—	20	5
051144-01929	24	—	20	5
051131-01930	16	—	20	5

3M™ Green Corps™ Roloc™ Discs

- The versatility of 3M™ Roloc™ product with the quality of Green Corps™ product.
- Handy, quick change tool for disc grinding which fits any standard 1/4" drill or air tool.
- Quick 1/2 turn on, 1/2 turn off speeds disc changing and cuts down time.
- The grit of any disc can be determined by the color of the plastic holding button:
 - Grade 50 – Green
 - Grade 36 – Brown
 - Grade 24 – Black
- See pages 43 and 54 for proper backup pad selection.



Part Number	Grade	Discs Per Box	Boxes Per Case
2" Diameter			
051131-01396	50YF	25	10
051131-01397	36YF	25	10
051131-01398	24YF	25	10
3" Diameter			
051131-01406	50YF	25	10
051131-01407	36YF	25	10
051131-01408	24YF	25	10

3M Standard Class Abrasives

	3" 3M™ Hookit™ Gold Discs 50/Box 4 Boxes/Case	5" 3M™ Hookit™ Gold Discs 100/Box 4 Boxes/Case	5" 3M™ Hookit™ Gold Discs Dust-Free 100/Box 4 Boxes/Case	5" 3M™ Stikit™ Gold Disc Rolls 75/Roll 6 or 12 Rolls/Case	5" 3M™ Stikit™ Gold Disc Rolls 175/Roll 6 Rolls/Case	5" 3M™ Stikit™ Gold Disc Rolls Dust-Free 175 Discs/Roll 6 Rolls/Case	5" 3M™ Production™ Fre-Cut™ Gold Paper Discs 100/Box 5 Boxes/Case	6" 3M™ Hookit™ Gold Discs 100/Box 4 Boxes/Case	
P1500									
P1200									
P1000									
P800									
P600									
P500	00912	00956			01417			00972	
P400	00913	00957	01057	01188	01419	01619	01019	00973	
P360								00974	
P320	00914	00959	01059	01190	01420	01620	01020	00975	
P280					01421			00976	
P240	00915	00961			01422	01622	01022	00977	
P220	00916	00962	01062	01193	01423	01623	01023	00978	
P180	00917	00963	01063	01194	01424	01624	01024	00979	
P150	00918	00964	01064	01195	01425	01625	01025	00980	
P120	00919	00965		01196	01426***	01626***	01026	00981	
P100	00920	00966		01197	01427***		01027	00982	
P80	00921	00967*	01067*	01198	01428***	01628***	01028	00983*	
		*75 Per Box	*75 Per Box		***125 Per Roll	***125 Per Roll		*75 Per Box	

continued from above on page 31	6" 3M™ Production™ Fre-Cut™ Gold Paper Discs 100/Box 5 Boxes/Case	8" 3M™ Stikit™ Gold Disc Rolls 125 Discs/Roll 4 Rolls/Case	2 3/4" X 16" 3M™ Hookit™ Gold Sheets 50/Box 5 Boxes/Case	2 3/4" X 25 Yds. 3M™ Stikit™ Production™ Gold Sheet Rolls 10 Rolls/Case	2 3/4" X 30 Yds. 3M™ Stikit™ Production™ Gold Sheet Rolls 10 Rolls/Case	2 3/4" X 45 Yds. 3M™ Stikit™ Production™ Gold Sheet Rolls 10 Rolls/Case	2 3/4" X 17 1/2" 3M™ Production™ Resinite™ Fre-Cut™ Gold Paper Sheets 50/Sleeve 5 Sleeves/Case	3 3/8" X 9" 3M™ Production™ Resinite™ Fre-Cut™ Gold Paper Sheets 50/Sleeve 5 Sleeves/Case	
P1500									
P1200									
P1000									
P800									
P600									
P500						02589			
P400	01034	01484				02590			
P360									
P320	01035	01485				02591		02551	
P280									
P240	01037	01487				02593			
P220	01038	01488	02469			02594	02567	02552	
P180	01039	01489	02470			02595	02568	02553	
P150		01490	02472			02596	02569	02554	
P120	01041	01491	02473		02597				
P100	01042	01492			02598				
P80	01043	01493		02599					

3M Standard Class Abrasives

	6" 3M™ Hookit™ Gold Discs Dust-Free 100/Box 4 Boxes/Case	6" 3M™ Stikit™ Gold Disc Rolls 75 Discs/Roll 6 or 12 Rolls/Case	6" 3M™ Stikit™ Gold Disc Rolls 175/Roll 6 Rolls/Case	6" 3M™ Stikit™ Gold Disc Rolls Dust-Free 175/Roll 6 Rolls/Case	6" 3M™ Stikit™ Gold Film Disc Rolls 75/Roll 6 Rolls/Case	6" 3M™ Stikit™ Gold Film Disc Rolls 125/Roll 4 Rolls/Case	6" 3M™ Stikit™ Gold Film Disc Rolls Dust-Free 125/Roll 4 Rolls/Case	6" 3M™ Stikit™ Gold Film Disc Rolls Dust-Free 125/Roll 4 Rolls/Case
								P1500
								P1200
								P1000
								P800
								P600
	01072	01202	01432	01633	01322	01352	01372	P500
	01073	01203	01433	01634	01323	01353	01373	P400
		01204	01434		01324	01354		P360
	01075	01205	01435	01635	01325	01355	01375	P320
	01076	01206	01436	01636	01326	01356	01376	P280
	01077	01207	01437	01637	01327	01357	01377	P240
	01078	01208	01438	01638	01328	01358	01378	P220
	01079	01209	01439	01639	01329	01359	01379	P180
	01080	01210	01440	01640	01330	01360	01380	P150
	01081	01211	01441***	01641***	01331	01361	01381	P120
	01082	01212	01442***	01642***	01332	01362	01382	P100
	01083	01213	01443***	01643***	01333	01363**	01383**	P80

***125 Per Roll

***125 Per Roll

**100 Per Roll

**100 Per Roll

6" 3M™ Stikit™ Gold Film Disc Rolls Dust-Free 125/Roll 4 Rolls/Case

Abrasives

	9" X 11" 3M™ Production™ Resinite™ Fre-Cut™ Gold Paper Sheets 50/Sleeve 5 Sleeves/Case	3" 3M™ Hookit™ Finishing Film Discs 50/Box 4 Boxes/Case	5" 3M™ Hookit™ Finishing Film Discs 100/Box 4 Boxes/Case	5" 3M™ Hookit™ Finishing Film Discs Dust-Free 100/Box 4 Boxes/Case	6" 3M™ Hookit™ Finishing Film Discs 100/Box 4 Boxes/Case	6" 3M™ Hookit™ Finishing Film Discs Dust-Free 100/Box 4 Boxes/Case	6" 3M™ Stikit™ Finishing Film Discs 100/Box 4 Boxes/Case	
		00907	00951		00950	01050		P1500
		00908	00952		00968	01068	01318	P1200
		00909	00953		00969	01069	01319	P1000
	02536	00910	00954		00970	01070	01320	P800
	02537	00911	00955	01055	00971	01071	01321	P600
	02538							P500
	02539							P400
	02540							P360
	02541							P320
	02542							P280
	02543							P240
	02544							P220
	02545							P180
	02546							P150
	02547							P120
	02548							P100
	02549							P80

3M Standard Class Abrasives

3M™ Hookit™ Gold Discs/Sheets

- Designed for use on paint and primer.
- Durable and long-lasting abrasive products.
- Hook-and-Loop attachment system.
- See pages 42, 44, 47 and 49 for proper backup pad selection.

Part Number	Grade	Discs Per Box	Boxes Per Case
3" Diameter			
051131-00912	P500	50	4
051131-00913	P400	50	4
051131-00914	P320	50	4
051131-00915	P240	50	4
051131-00916	P220	50	4
051131-00917	P180	50	4
051131-00918	P150	50	4
051131-00919	P120	50	4
051131-00920	P100	50	4
051131-00921	P80	50	4
5" Diameter			
051131-00956	P500	100	4
051131-00957	P400	100	4
051131-00959	P320	100	4
051131-00961	P240	100	4
051131-00962	P220	100	4
051131-00963	P180	100	4
051131-00964	P150	100	4
051131-00965	P120	100	4
051131-00966	P100	100	4
051131-00967	P80	75	4
6" Diameter			
051131-00972	P500	100	4
051131-00973	P400	100	4
051131-00974	P360	100	4
051131-00975	P320	100	4
051131-00976	P280	100	4
051131-00977	P240	100	4
051131-00978	P220	100	4
051131-00979	P180	100	4
051131-00980	P150	100	4
051131-00981	P120	100	4
051131-00982	P100	100	4
051131-00983	P80	75	4

Part Number	Grade	Sheets Per Box	Boxes Per Case
2-3/4" x 16"			
051131-02469	P220	50	5
051131-02470	P180	50	5
051131-02472	P150	50	5
051131-02473	P120	50	5

3M™ Hookit™ Gold Discs/Sheets (continued)

Part Number	Grade	Discs Per Box	Boxes Per Case
5" Diameter			
051131-01057*	P400	100	4
051131-01059*	P320	100	4
051131-01062*	P220	100	4
051131-01063*	P180	100	4
051131-01064*	P150	100	4
051131-01067*	P80	75	4
6" Diameter			
051131-01072*	P500	100	4
051131-01073*	P400	100	4
051131-01075*	P320	100	4
051131-01076*	P280	100	4
051131-01077*	P240	100	4
051131-01078*	P220	100	4
051131-01079*	P180	100	4
051131-01080*	P150	100	4
051131-01081*	P120	100	4
051131-01082*	P100	100	4
051131-01083*	P80	75	4

*Dust-free products are prepunched with a standard hole pattern for dust-free sanding.

3M™ Stikit™ Gold and 3M™ Stikit™ Production™ Gold Disc/Sheet Rolls



- Designed for use on paint and primer.
- Durable and long lasting abrasive products.
- Pressure-sensitive adhesive (PSA) backing.
- See pages 42, 44, 45 and 46 for proper backup pad selection.

Part Number	Grade	Discs Per Roll	Rolls Per Case
5" Diameter			
051131-01188	P400	75	6
051131-01190	P320	75	12
051131-01193	P220	75	12
051131-01194	P180	75	12
051131-01195	P150	75	6
051131-01196	P120	75	6
051131-01197	P100	75	6
051131-01198	P80	75	12
5" Diameter			
051131-01417	P500	175	6
051131-01419	P400	175	6
051144-01420	P320	175	6
051144-01421	P280	175	6
051144-01422	P240	175	6
051144-01423	P220	175	6
051144-01424	P180	175	6
051144-01425	P150	175	6

3M Standard Class Abrasives

3M™ Stikit™ Gold and 3M™ Stikit™ Production™ Gold Disc/Sheet Rolls (continued)

Part Number	Grade	Discs Per Roll	Rolls Per Case
5" Diameter			
051144-01426	P120	125	10
051144-01427	P100	125	10
051144-01428	P80	125	10
6" Diameter			
051131-01202	P500	75	6
051131-01203	P400	75	6
051131-01204	P360	75	6
051131-01205	P320	75	12
051131-01206	P280	75	6
051131-01207	P240	75	6
051131-01208	P220	75	12
051131-01209	P180	75	12
051131-01210	P150	75	6
051131-01211	P120	75	6
051131-01212	P100	75	6
051131-01213	P80	75	12
6" Diameter			
051131-01432	P500	175	6
051131-01434	P400	175	6
051131-01433	P360	175	6
051144-01435	P320	175	6
051144-01436	P280	175	6
051144-01437	P240	175	6
051144-01438	P220	175	6
051144-01439	P180	175	6
051144-01440	P150	175	6
6" Diameter			
051144-01441	P120	125	10
051144-01442	P100	125	10
051144-01443	P80	125	10
8" Diameter			
051131-01484	P400	125	4
051131-01485	P320	125	4
051131-01487	P240	125	4
051131-01488	P220	125	4
051131-01489	P180	125	4
051131-01490	P150	125	4
051131-01491	P120	125	4
051131-01492	P100	125	4
051131-01493	P80	125	4

3M™ Stikit™ Gold and 3M™ Stikit™ Production™ Gold Disc/Sheet Rolls (continued)

Part Number	Grade	Rolls Per Case
2-3/4" x 25 Yards		
051131-02599	P80	10
2-3/4" x 30 Yards		
051131-02597	P120	10
051131-02598	P100	10
2-3/4" x 45 Yards		
051131-02589	P500	10
051131-02590	P400	10
051131-02591	P320	10
051131-02593	P240	10
051131-02594	P220	10
051131-02595	P180	10
051131-02596	P150	10



Part Number	Grade	Discs Per Roll	Rolls Per Case
5" Diameter			
051131-01619*	P400	175	6
051131-01620*	P320	175	6
051131-01622*	P240	175	6
051131-01623*	P220	175	6
051131-01624*	P180	175	6
051131-01625*	P150	175	6
5" Diameter			
051131-01626*	P120	125	10
051131-01628*	P80	125	10
6" Diameter			
051131-01633*	P500	175	6
051131-01634*	P400	175	6
051131-01635*	P320	175	6
051131-01636*	P280	175	6
051131-01637*	P240	175	6
051131-01638*	P220	175	6
051131-01639*	P180	175	6
051131-01640*	P150	175	6
6" Diameter			
051131-01641*	P120	125	10
051131-01642*	P100	125	10
051131-01643*	P80	125	10

*Dust-free products are prepunched with a standard hole pattern for dust-free sanding. See pages 42 and 53 for proper backup pad selection.

3M Standard Class Abrasives

3M™ Stikit™ Gold Film Discs

- Tough film backing.
- Designed for use on paint and primer.
- Durable and long-lasting abrasive products.
- Pressure-sensitive adhesive (PSA) backing.
- See pages 42, 44 and 46 for proper backup pad selection.



Part Number	Grade	Discs Per Roll	Rolls Per Case
6" Diameter			
051131-01322	P500	75	6
051131-01323	P400	75	6
051131-01324	P360	75	6
051131-01325	P320	75	6
051131-01326	P280	75	6
051131-01327	P240	75	6
051131-01328	P220	75	6
051131-01329	P180	75	6
051131-01330	P150	75	6
051131-01331	P120	75	6
051131-01332	P100	75	6
051131-01333	P80	75	6
6" Diameter			
051131-01352	P500	125	4
051131-01353	P400	125	4
051131-01354	P360	125	4
051131-01355	P320	125	4
051131-01356	P280	125	4
051131-01357	P240	125	4
051131-01358	P220	125	4
051131-01359	P180	125	4
051131-01360	P150	125	4
051131-01361	P120	125	4
051131-01362	P100	125	4
6" Diameter			
051131-01363	P80	100	4



Part Number	Grade	Discs Per Roll	Rolls Per Case
6" Diameter			
051131-01372*	P500	125	4
051131-01373*	P400	125	4
051131-01375*	P320	125	4
051131-01376*	P280	125	4
051131-01377*	P240	125	4
051131-01378*	P220	125	4
051131-01379*	P180	125	4
051131-01380*	P150	125	4
051131-01381*	P120	125	4
051131-01382*	P100	125	4
6" Diameter			
051131-01383*	P80	100	4

*Dust-free products are prepunched with a standard hole pattern for dust-free sanding. See pages 42, 44 and 53 for proper backup pad selection.

3M™ Gold Dry Discs/Sheets

- Designed for use on paint and primer.
- Durable and long-lasting abrasive products.
- See pages 43 and 55 for proper backup pad selection.



Part Number	Grade	Discs Per Box	Boxes Per Case
5" Diameter			
051131-01019	P400A	100	5
051131-01020	P320A	100	5
051131-01022	P240A	100	5
051131-01023	P220A	100	5
051131-01024	P180A	100	5
051131-01025	P150A	100	5
051131-01026	P120A	100	5
051131-01027	P100A	100	5
051131-01028	P80A	100	5
6" Diameter			
051131-01034	P400A	100	5
051131-01035	P320A	100	5
051131-01037	P240A	100	5
051131-01038	P220A	100	5
051131-01039	P180A	100	5
051131-01041	P120A	100	5
051131-01042	P100A	100	5
051131-01043	P80A	100	5

Part Number	Grade	Sheets Per Sleeve	Sleeves Per Case
2-3/4" x 17-1/2"			
051131-02567	P220	50	5
051131-02568	P180	50	5
051131-02569	P150	50	5
3-2/3" x 9"			
051131-02551	P320	100	5
051131-02552	P220	100	5
051131-02553	P180	100	5
051131-02554	P150	100	5
9" x 11"			
051131-02536	P800	50	5
051131-02537	P600	50	5
051131-02538	P500	50	5
051131-02539	P400	50	5
051131-02540	P360	50	5
051131-02541	P320	50	5
051131-02542	P280	50	5
051131-02543	P240	50	5
051131-02544	P220	50	5
051131-02545	P180	50	5
051131-02546	P150	50	5
051131-02547	P120	50	5
051131-02548	P100	50	5
051131-02549	P80	50	5

3M Standard Class Abrasives

3M™ Hookit™ Finishing Film

- High-performing aluminum oxide.
- Cuts fast, lasts long, resists loading and leaves a consistent finish.
- For use in scuff sanding before painting.
- Use to remove runs, dust nibs and excess orange peel from topcoat finishes.
- Hook-and-Loop attachment system.
- See pages 42, 44, 47, 48 and 49 for proper backup pad selection.



3M™ Stikit™ Finishing Film

- High-performing aluminum oxide.
- Cuts fast, lasts long, resists loading and leaves a consistent finish.
- For use in scuff sanding before painting.
- Use to remove runs, dust nibs and excess orange peel from topcoat finishes.
- Pressure-sensitive adhesive (PSA) backing.
- See pages 42, 44 and 45 for proper backup pad selection.



Part Number	Grade	Discs Per Box	Boxes Per Case
3" Diameter			
051131-00907	P1500	50	4
051131-00908	P1200	50	4
051131-00909	P1000	50	4
051131-00910	P800	50	4
051131-00911	P600	50	4
5" Diameter			
051131-00951	P1500	100	4
051131-00952	P1200	100	4
051131-00953	P1000	100	4
051131-00954	P800	100	4
051131-00955	P600	100	4
6" Diameter			
051131-00950	P1500	100	4
051131-00968	P1200	100	4
051131-00969	P1000	100	4
051131-00970	P800	100	4
051131-00971	P600	100	4

Part Number	Grade	Discs Per Box	Boxes Per Case
5" Diameter			
051131-01055*	P600	100	4
6" Diameter			
051131-01050*	P1500	100	4
051131-01068*	P1200	100	4
051131-01069*	P1000	100	4
051131-01070*	P800	100	4
051131-01071*	P600	100	4

*Dust-free products are prepunched with a standard hole pattern for dust-free sanding.

Part Number	Grade	Discs Per Box	Boxes Per Case
6" Diameter			
051131-01318	P1200	100	4
051131-01319	P1000	100	4
051131-01320	P800	100	4
051131-01321	P600	100	4

3M Utility Class Abrasives

	3" 3M™ Kut-Down Discs 20/Box 4 Boxes/Case	5" X 3/8" 3M™ General Purpose Grinding Discs 10/Box 10 Boxes/Case	5" X 1/2" 3M™ Type D Discs (Open Coat) 25/Box 4 Boxes/Case	7" X 3/8" 3M™ General Purpose Grinding Discs 10/Box 10 Boxes/Case	7" X 1/2" 3M™ Type D Discs (Open Coat) 25/Box 4 Boxes/Case	7" X 3/4" 3M™ Tri-M-ite™ Resin Bond Cloth Discs TCI 50/Box 5 Boxes/Case	9 1/2" X 3/8" 3M™ Type D Discs (Open Coat) 25/Box 4 Boxes/Case	2 3/4" X 16 1/2" 3M™ Stikit™ Production™ Sheets, D Wt. 100/Box 5 Boxes/Case	2 1/2" X 17 1/2" 3M™ Production™ Paper Sheets, D Wt. (Open Coat) 100/Box 5 Boxes/Case
400									
360									
320									
280									
240									
220									
180									
150									
120						01613			
100									02134**
80						01614		02241*	02135
60									02136
50	01429	01932		01937 (Kut Item)					
40							02248		02138
36	01430	01933	01818	01938	01833		01867		02139
24	01431	01934	01819	01939	01834		01868		
16			01820		01835				

continued
below

*3M™ Fre-Cut™ Sheet **200/Sleeve
10 Sleeves/Case

	3 3/8" X 9" 3M™ Production™ Paper Sheets, C Wt., D Wt. (Open Coat) 200 or 400/Box 5 or 10 Boxes/Case	3" X 8" 3M™ Production™ Paper Sheets, D Wt. (Open Coat) 200/Box 10 Boxes/Case	9" X 11" 3M™ Production™ Paper Sheets, (Open Coat) 50 or 100/Box 5 or 10 Boxes/Case	9" X 11" 3M™ Tri-M-ite™ Fre-Cut™ Paper Sheets 100/Sleeve 10 Sleeves/Case	6" 3M™ Stikit™ Tri-M-ite™ Fre-Cut™ Disc Rolls 125/Roll 8 Rolls/Case	6" 3M™ Stikit™ Tri-M-ite™ Fre-Cut™ Disc Rolls 250/Roll 4 Rolls/Case	4 1/2" X 5 1/2" 3M™ Softback Sanding Sponge Sheets 20/Box 6 Boxes/Case	3" X 1/2" X 3/8" 3M™ General Purpose Cut-Off Wheel	3" X 1/8" X 3/8" 3M™ General Purpose Cut-Off Wheel
								01987***	01988***
400				02342			02600		
360							02601		
320				02344		01465	02602		
280				02345		01466	02604		
240				02346		01467	02606		
220			02103	02347		01468			
180			02104	02348		01469			
150	02172		02112	02349		01470			
120	02173		02113	02350	01471				
100	02174		02114	02356	01472				
80	02175	02145	02115		01473				
60			02116						
50			02117						
40			02118						
36			02119						
24									
16									

***No Grade ***No Grade

3M Utility Class Abrasives

3M™ Kut-Down Discs

- Discs can be cut down for extended life.
- Handy, quick change disc for grinding small or hard-to-reach areas.
- Fits 1/4" drill or pistol type air grinder.
- Use adapter PN05533.
- See pages 43 and 54 for proper backup pad selection.

Part Number	Grade	Discs Per Box	Boxes Per Case
3" Diameter			
051131-01429	50	20	4
051131-01430	36	20	4
051131-01431	24	20	4

3M™ General Purpose Grinding Discs

- Designed for general purpose paint removal and metalwork.
- See pages 43 and 54 for proper backup pad selection.

Part Number	Grade	For Use with Disc/ Backup Pad	Discs Per Box	Boxes Per Case
5" x 7/8"				
051131-01932	50	PN05637	10	10
051131-01933	36	PN05637	10	10
051131-01934	24	PN05637	10	10
7" x 7/8"				
051131-01937*	50	PN05634	10	10
051131-01938	36	PN05634	10	10
051131-01939	24	PN05634	10	10

*Kut Item

3M™ General Purpose Cut-Off Wheels

- Used for cutting auto body sheet metal, frame rails, clamps and rusted bolts.
- For use on utility type cut-off tools.
- **NOTE: Read all warnings supplied with wheels. DO NOT use on tool without guards.**



Part Number	Size	Wheels Per Case
051131-01987	3" x 1/32" x 3/8"	50
051131-01988	3" x 1/16" x 3/8"	50

3M™ Type D Discs (Open Coat)

- Designed for paint removal and metal work.
- Resists loading on acrylics.
- Recommended speeds:
 - Size 5" – 7,650 RPM
 - Size 7" – 5,500 RPM
 - Size 9" – 4,200 RPM
- See pages 43 and 54 for proper backup pad selection.



Part Number	Grade	For Use with Disc/ Backup Pad	Discs Per Box	Boxes Per Case
5" x 7/8"				
051144-01818	36	PN05637	25	4
051144-01819	24	PN05637	25	4
051144-01820	16	PN05637	25	4
9-1/8" x 7/8"				
051144-01867	36	—	25	4
051144-01868	24	—	25	4
7" x 7/8"				
051144-01833	36	PN05634	25	4
051144-01834	24	PN05634	25	4
051144-01835	16	PN05634	25	4

3M Utility Class Abrasives

3M™ Tri-M-ite™ Resin Bond Cloth Discs

- Durable, long-lasting disc.
- Excellent for glass edge grinding.
- Silicon carbide mineral provides sharpness, resists dulling and is fast-cutting.
- See page 43 for proper backup pad selection.

Part Number	Grade	For Use with Disc/ Backup Pad	Discs Per Box	Boxes Per Case
7" x 7/8"				
051144- 01613	120X	PN05634	50	5
051144- 01614	80X	PN05634	50	5

3M™ Stikit™ Production™ Sheets (D Weight)

- Specially treated to prevent loading.
- Durable backing.
- Pressure-sensitive adhesive (PSA) backing.
- See pages 42 and 46 for proper backup pad selection.



Part Number	Grade	Sheets Per Box	Boxes Per Case
2-3/4" x 16-1/2"			
051144- 02241 †	80D	100	5
051144- 02248	40D	100	5

† 3M™ Fre-Cut™ Sheet

3M™ Production™ Paper Sheets

- Dry sanding only on machine or by hand.
- Open coat resists loading.
- Works well for shaping and finishing plastic filler and featheredging.
- See page 55 for proper backup pad selection.



Part Number	Grade	Sheets Per Box	Boxes Per Case
2-3/4" x 17-1/2"			
051144- 02134 **	100C	200	10
051144- 02135	80D	100	10
051144- 02136	60D	100	10
051144- 02138	40D	100	5
051144- 02139	36D	100	5
3-2/3" x 9"			
051144- 02172	150C	400	10
051144- 02173	120C	400	10
051144- 02174	100C	400	10
051144- 02175	80D	200	10
3" x 8"			
051144- 02145	80D	200	10

** 200 Sheets Per Sleeve; 10 Sleeves Per Case

Part Number	Grade	Sheets Per Sleeve	Sleeves Per Case
9" x 11"			
051144- 02103	220A	100	10
051144- 02104	180A	100	10
051144- 02112	150C	100	10
051144- 02113	120C	100	10
051144- 02114	100C	100	10
051144- 02115	80D	50	10
051144- 02116	60D	50	10
051144- 02117	50D	50	10
051144- 02118	40D	50	5
051144- 02119	36D	50	5

3M Utility Class Abrasives

3M™ Stikit™ Tri-M-ite™ Fre-Cut™ Disc Rolls

- Treated to minimize loading.
- Pressure-sensitive adhesive (PSA) backing.
- See pages 42, 44 and 45 for proper backup pad selection.



Part Number	Grade	Discs Per Roll	Rolls Per Case
6" Diameter			
051144-01471	120A	125	8
051144-01472	100A	125	8
051144-01473	80A	125	8
6" Diameter			
051144-01465	320A	250	4
051144-01466	280A	250	4
051144-01467	240A	250	4
051144-01468	220A	250	4
051144-01469	180A	250	4
051144-01470	150A	250	4

3M™ Softback Sanding Sponge Sheets

- Flexible abrasive coated foam sheets.
- Enable users to sand hard-to-reach areas.
- Help eliminate finger marks.
- Can be used wet or dry.



Part Number	Grade	Sponges Per Box	Boxes Per Case
4-1/2" x 5-1/2"			
051131-02600	Microfine 400	20	6
051131-02601	Ultrafine 360	20	6
051131-02602	Superfine 320	20	6
051131-02604	Fine 280	20	6
051131-02606	Medium 240	20	6

3M™ Tri-M-ite™ Fre-Cut™ Paper Sheets

- Treated to minimize loading.
- Pressure-sensitive adhesive (PSA) backing.
- See page 55 for proper backup pad selection.



Part Number	Grade	Sheets Per Sleeve	Sleeves Per Case
9" x 11"			
051144-02342	400A	100	10
051144-02344	320A	100	10
051144-02345	280A	100	10
051144-02346	240A	100	10
051144-02347	220A	100	10
051144-02348	180A	100	10
051144-02349	150A	100	10
051144-02350	120A	100	10
051144-02356	100C	100	10

3M™ Wetordry™ Abrasives

	9" X 11" 3M™ Imperial™ Wetordry™ Paper Sheets 50/Sleeve 5 Sleeves/Case	9" X 11" 3M™ Imperial™ Wetordry™ Paper Sheets 50/Sleeve 5 Sleeves/Case	5½" X 9" 3M™ Imperial™ Wetordry™ Paper Sheets 50/Sleeve 5 Sleeves/Case	5½" X 9" 3M™ Imperial™ Wetordry™ Paper Sheets C Wt., 50/Sleeve 5 Sleeves/Case	9" X 11" 3M™ Tri-M-Ite™ Wetordry™ Paper Sheets 50/Sleeve 5 or 10 Sleeves/Case	2¾" X 17½" 3M™ Tri-M-Ite™ Wetordry™ Paper Sheets 100/Box 10 Boxes/Case	1½" 3M™ Finesse-It™ Imperial™ Wetordry™ Scalloped Discs 10/Sleeve 10 Sleeves/Case
2500		02019	02045	02625			
2000		02020	02044	02624			
1500		02032	02023	02623			05921
1200		02033	02022	02622			
1000		02034	02021	02621			
800	02035						
600	02036				02000		
500	02037				02001		
400	02038				02002		
360	02039				02003		
320	02040				02004		
280	02041				02005		
240	02042				02006	02086	
220	02043				02007		
180					02014		
150					02015		
120					02016		
100					02017		
80					02018		

3M™ Wetordry™ Abrasives

3M™ Imperial™ Wetordry™ Paper Sheets

- Premium, aluminum oxide mineral, an improved paper backing and an optimized construction.
- Performance advantages: Improved rate of cut, increased abrasive life, increased flexibility and uniform, consistent finish.

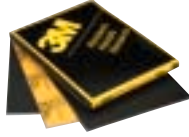

Part Number	Grade	Sheets Per Sleeve	Sleeves Per Case
9" x 11"			
051131-02035	P800	50	5
051131-02036	P600	50	5
051131-02037	P500	50	5
051131-02038	P400	50	5
051131-02039	P360	50	5
051131-02040	P320	50	5
051131-02041	P280	50	5
051131-02042	P240	50	5
051131-02043	P220	50	5

3M™ Imperial™ Wetordry™ Paper Sheets

- Designed for light sanding prior to compounding.
- Sheet size eliminates the need of tearing — entire sheet can be used.
- Durable backing resists tearing and wrinkling.



Part Number	Grade	Sheets Per Sleeve	Sleeves Per Case
5-1/2" x 9"			
051131-02045	Micro Fine 2500	50	5
051131-02044	Micro Fine 2000	50	5
051131-02023	Micro Fine 1500	50	5
051131-02022	Micro Fine 1200	50	5
051144-02021	Ultra Fine 1000	50	5
9" x 11"			
051131-02019	Micro Fine 2500	50	5
051131-02020	Micro Fine 2000	50	5
051131-02032	Micro Fine 1500	50	5
051131-02033	Micro Fine 1200	50	5
051131-02034	Ultra Fine 1000	50	5

3M™ Imperial™ Wetordry™ Paper Sheets (C Weight)

- Durable "C weight" backing resists tearing and wrinkling.
- Designed for light sanding prior to compounding.

Part Number	Grade	Sheets Per Sleeve	Sleeves Per Case
5-1/2" x 9"			
051131-02625	2500C	50	5
051131-02624	2000C	50	5
051131-02623	1500C	50	5
051131-02622	1200C	50	5
051131-02621	1000C	50	5

3M™ Wetordry™ Tri-M-ite™ Paper Sheets

- Use wet with water or dry for sanding old finishes, fine featheredging and surface sanding.
- 3M™ Wetordry™ stays flexible and cuts fast.



Part Number	Grade	Sheets Per Sleeve	Sleeves Per Case
9" x 11"			
051144-02000	600A	50	10
051144-02001	500A	50	5
051144-02002	400A	50	10
051144-02003	360A	50	5
051144-02004	320A	50	10
051144-02005	280A	50	5
051144-02006	240A	50	5
051144-02007	220A	50	10
051144-02014	180C	50	5
051144-02015	150C	50	5
051144-02016	120C	50	5
051144-02017	100C	50	5
051144-02018	80C	50	5

Part Number	Grade	Sheets Per Box	Boxes Per Case
2-3/4" x 17-1/2"			
051144-02086	240A	100	10

3M™ Finesse-It™ Imperial™ Wetordry™ Scalloped Discs

- Scalloped to eliminate edge cutting.
- Permits easy application to and removal from our 3M™ Finesse-It™ Hand Sanding Pad (PN13441).

Part Number	Diameter Size	Sheets Per Sleeve	Sleeves Per Case
051131-05921	1-3/8"	10	10

3M Abrasive Accessories

	3M™ Hookit™ II	3M™ Hookit™ II Dust-Free	3M™ Imperial™ Hookit™ II	3M™ Hookit™	3M™ Hookit™ Regalite™	3M™ Hookit™ Dust-Free	3M™ Stikit™	
Abrasive Organizer								
Air File Shoe 2 3/4" X 11"			05250					
Air File Shoe 2 3/4" X 16"	05248							
Air File Shoe 2 3/4" X 16 1/2"				05748			05448	
Backup Pad 5"								
Backup Pad 7"								
Bodyman Pad 6"	05276							
Bodyman Pad 8"	05279							
Bucket								
Disc Adapters 3"								
Disc Hand Pad 6"							05591	
Disc Pad 3"	05269, 05270			05769				
Disc Pad 5"				05775			05575	
Disc Pad 6"				05776			05576	
Disc Pad 8"	05280#	05380#			05779		05579	
5 Mounting Holes	05281	05381		05781		05881	05581	
6 Mounting Holes	05282, 05283	05382#		05782, 05783#			05582	
Disc Pad Assembly 1"								
Disc Pad Assembly 2"								
Disc Pad Assembly 3"								
Disc Pad Assembly 4"								
Disc Roll Dispenser							05450	
75 Disc Roll Dispenser							05451#	
Double Roll Dispenser							05452	
Half Round Soft Hand Pad 6"	05292							
Half Round Hand Pad 6"				05792				
Hand Block 2 3/4" X 5"	05240			05740			05440	
Hand Block 2 3/4" X 7 3/4"	05241			05741			05441	
Hand File Board 2 3/4" X 16"	05244			05744			05444	
Hand Pad 5"							05585	
Hand Pad 6"	05291			05791			05586	
Hub and Retainer Nut								
Retainer Nut								
Low Profile Backup Pad 5"		05355				05855		
Low Profile Backup Pad 6"		05356, 05357#				05856		
Low Profile Disc Pad 5"				05755			05555	
Low Profile Disc Pad 6"				05756			05556	
Low Profile Finishing Disc Pad 6"							05546	
Orbital Air File Shoe				05746#			05446#	
Painter Pad 6"	05286							
Primer Finishing Pad 5"	05275							
Primer Finishing Pad 6"	05251	05351						
Rubber Sanding Block 2 3/4" X 5"								
Rubber Sanding Block 2 3/4" X 8"								
Rubber Squeegee 2 3/4" X 4 1/2"								
Rubber Squeegee 3" X 2"								
Soft Disc Pad 8"	05268			05768			05568	
Soft Hand Block 2 3/4" X 5"	05242			05742			05442	
Soft Hand Pad 2 3/4" X 5 1/2"							05530	
Soft Interface Pad 3"	05271			05771				
Soft Interface Pad 5"	05273			05773				
Soft Interface Pad 6"	05274			05774				
Sponge Pad, No. 20								
Straight Line Air File Shoe		05348#		05750#		05848#		

To order call VLR at 1-800-843-0619 or access website at www.cmprovhi.com

3M Abrasive Accessories

3M™ Stikit™ Dust-Free	Dry	3M™ Roloc™	Fibre Disc	3M™ Kut-Down™	Glue On	3M™ Wetordry™	Misc.	
							02500	Abrasive Organizer
								Air File Shoe 2 3/4" X 11"
								Air File Shoe 2 3/4" X 16"
								Air File Shoe 2 3/4" X 16 1/2"
			05637					Backup Pad 5"
			05634					Backup Pad 7"
								Bodyman Pad 6"
								Bodyman Pad 8"
						02513		Bucket
				05533				Disc Adapters 3"
								Disc Hand Pad 6"
								Disc Pad 3"
					05577			Disc Pad 5"
					05578			Disc Pad 6"
								Disc Pad 8"
05681#								5 Mounting Holes
								6 Mounting Holes
		05538						Disc Pad Assembly 1"
		05539						Disc Pad Assembly 2"
		05540						Disc Pad Assembly 3"
		05541						Disc Pad Assembly 4"
								Disc Roll Dispenser
								75 Disc Roll Dispenser
								Double Roll Dispenser
								Half Round Soft Hand Pad 6"
								Half Round Hand Pad 6"
								Hand Block 2 3/4" X 5"
								Hand Block 2 3/4" X 7 3/4"
								Hand File Board 2 3/4" X 16"
								Hand Pad 5"
								Hand Pad 6"
			05633					Hub and Retainer Nut
			05632					Retainer Nut
								Low Profile Backup Pad 5"
								Low Profile Backup Pad 6"
05655								Low Profile Disc Pad 5"
05656								Low Profile Disc Pad 6"
05646								Low Profile Finishing Disc Pad 6"
								Orbital Air File Shoe
								Painter Pad 6"
								Primer Finishing Pad 5"
								Primer Finishing Pad 6"
	05519							Rubber Sanding Block 2 3/4" X 5"
	05520							Rubber Sanding Block 2 3/4" X 8"
						05517		Rubber Squeegee 2 3/4" X 4 1/2"
						05518		Rubber Squeegee 3" X 2"
								Soft Disc Pad 8"
								Soft Hand Block 2 3/4" X 5"
								Soft Hand Pad 2 3/4" X 5 1/2"
								Soft Interface Pad 3"
								Soft Interface Pad 5"
								Soft Interface Pad 6"
						05526		Sponge Pad, No. 20
								Straight Line Air File Shoe

3M Abrasive Accessories

3M™ Stikit™, 3M™ Hookit™ and 3M™ Hookit™ II 6" D/A Backup Pad Guide

	Filler	Rough Featheredging	Fine Featheredging	Primer	Clear Coat Scuffing	Paint Finishing
3M™ Stikit™ Low Profile Finishing Disc Pad (PN05546)				●	●	●
3M™ Stikit™ Low Profile Disc Pad (PN05556)	●	●	●	●	●	
3M™ Stikit™ Disc Pad (PN05576)	●	●	●	●		
3M™ Hookit™ Low Profile Disc Pad (PN05756)	●	●	●	●	●	●
3M™ Hookit™ Disc Pad (PN05776)	●	●	●	●	●	●
3M™ Hookit™ Soft Interface Pad for 6" Disc (PN05774)				●	●	●
3M™ Hookit™ II Standard Pad (PN05276)	●	●	●			
3M™ Hookit™ II Primer Pad (PN05251)*		●	●	●	●	●
3M™ Hookit™ II Painter's Pad (PN05286)		●	●	●	●	●
3M™ Hookit™ II Soft Interface Pad (PN05274)				●	●	●

* Part number 05351 is the dust-free version of part number 05251.









 = recommended pad for use

 = use together

NOTE: The painter's pad (PN05286) and the primer pad (PN05251) are the same hardness with only a profile difference.

3M Abrasive Accessories

3M™ Stikit™ 5", 6" & 8" Disc Pads

Part Number	Disc Size	Pads/Case	Max RPM	Features	Tool Types	
3M™ Stikit™ Low Profile Finishing Disc Pad						
051131- 05546	6"	10	10,000	<ul style="list-style-type: none"> • Soft foam — finer finish • Low profile design • For fine grade 3M™ Stikit™ Gold, Gold Film and 3M™ Stikit™ Finishing Film Discs 	Dual Action & Random Orbital	 05546
3M™ Stikit™ Low Profile Disc Pads						
051131- 05555	5"	10	10,000	<ul style="list-style-type: none"> • Low profile design • Very good edge support • Lightweight, sands flat 	Dual Action & Random Orbital	 05555
051131- 05556	6"	10	10,000			 05556
3M™ Stikit™ Soft Disc Pads						
051131- 05568	8"	1	3,000	<ul style="list-style-type: none"> • Excellent conformability • For finish sanding topcoats • For fine grade 3M™ Stikit™ Discs 	Variable speed polisher/grinders with 5/8" shaft	 05568
3M™ Stikit™ Disc Pads						
051144- 05575	5"	10	10,000	<ul style="list-style-type: none"> • Tapered edge • Conformable • Designed for 3M™ Stikit™ Discs 	Dual Action & Random Orbital	 05575
051144- 05576	6"	10	10,000			 05576
3M™ Stikit™ Disc Pad for 8" Discs						
051144- 05579	8"	1	3,000	<ul style="list-style-type: none"> • Tapered edge • Conformable • Designed for 3M™ Stikit™ Discs • Shaping, stripping 	Slow speed polisher/grinders with 5/8" shaft	 05579
3M™ Stikit™ 8" Replacement Disc Pads (for gear driven 8" sanders)						
051131- 05581 (For tools with 5 mounting holes)		1	1,500	<ul style="list-style-type: none"> • Designed for 3M™ Stikit™ Discs • For shape sanding PI Filler • Low profile design 	See reference chart on page 58.	 05581
051131- 05582 (For tools with 6 mounting holes)		1	1,500			 05582

3M Abrasive Accessories

3M™ Stikit™ Sheet & Roll Accessories

Part Number	Size	Qty./Case	Features	Tool Types
3M™ Stikit™ Air File Shoe				
051144- 05448	2-3/4" x 16"	5	<ul style="list-style-type: none"> • Designed for 3M™ Stikit™ Sheets and Rolls • Excellent support • Durable, long-wearing • Front clip aligns sheets 	For all standard straight line air files using two mounting bolts



05448

3M™ Stikit™ Hand & Sheet Roll Accessories

Part Number	Size	Qty./Case	Features
3M™ Stikit™ Hand Blocks			
051144- 05440	2-3/4" x 5"	10	<ul style="list-style-type: none"> • Designed for 3M™ Stikit™ Sheets and Rolls • Produces a true flat surface • Shaped to fit the hand • Tough, durable, long-wearing
051144- 05441	2-3/4" x 7-3/4"	10	
3M™ Stikit™ Soft Hand Block			
051144- 05442	2-3/4" x 5"	10	<ul style="list-style-type: none"> • Designed for 3M™ Stikit™ Sheets and Rolls • Durable foam enables contour and flat sanding • Shaped to fit the hand
3M™ Stikit™ Hand File Board			
051144- 05444	2-3/4" x 16"	1	<ul style="list-style-type: none"> • Designed for 3M™ Stikit™ Sheets and Rolls • Durable, resistant to most solvents • Can be used two- or one-handed • Embossed rubber face that allows good adhesion release
3M™ Stikit™ Hand Pads			
051144- 05585	5"	10	<ul style="list-style-type: none"> • For all grades of 3M™ Stikit™ Discs • Defined edges for body lines • Good for contour sanding • Abrasive support for blocking and featheredging
051144- 05586	6"	10	
3M™ Stikit™ Disc Hand Pad			
051131- 05591	6"	20	<ul style="list-style-type: none"> • Unique design enables full use of 3M™ Stikit™ Discs • Good support for fine grade sanding • Eliminates finger marks • Pad is 1/4" thick

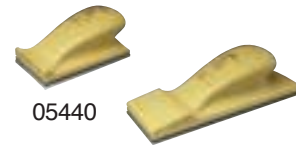

05440

05441

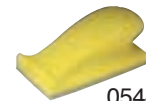

05442



05444



05585



05586



05591

3M Abrasive Accessories

3M™ Hookit™ and 3M™ Hookit™ II 3", 5", 6" & 8" Disc Pads

Part Number	Size	Qty./ Case	Max RPM	Features	Tool Types
3M™ Hookit™ Low Profile Disc Pads					
051131-05755	5"	10	12,000	• Designed for 3M™ Hookit™ Discs	Dual Action & Random Orbital
051131-05756	6"	10	12,000	• Low profile design • Good disc support edges	
3M™ Hookit™ and Hookit™ II Soft Disc Pads					
051131-05268	8"	1	3,000	• Designed for 8" 3M™ Hookit™ II Discs • Conformable	Slow speed sander/polisher with 5/8" shaft
051131-05768	8"	1	1,500	• Designed for 8" 3M™ Hookit™ Discs fine grades • Conformable • Produces finer finishes	
3M™ Hookit™ and Hookit™ II Disc Pads for Snap-On Sanders					
051131-05769	3"	5	15,000	• Use with 3M™ Hookit™ Soft Interface Pad (PN05771) for paint finishing and defect removal	Snap-On AT402, AT403P sanders
051131-05269	3"	5	15,000	• Use with 3M™ Hookit™ II Soft Interface Pad (PN05271) for paint finishing and defect removal	
3M™ Hookit™ Disc Pad					
051131-05775	5"	10	10,000	• Designed for 3M™ Hookit™ Discs	Dual Action & Random Orbital
051131-05776	6"	10	10,000	• Tapered edge • Durable, well-balanced	
3M™ Hookit™ Regalite™ Disc Pad					
051131-05779	8"	1	3,000	• Designed for 8" 3M™ Hookit™ Regalite™ Discs • Tapered edge for contours • Durable molded face	Slow speed sander/polisher with 5/8" shaft



05755



05756



05268



05768



05769



05775



05776



05779

3M Abrasive Accessories

3M™ Hookit™ and 3M™ Hookit™ II 3", 5", 6" & 8" Disc Pads (continued)

Part Number	Size	Qty./ Case	Max RPM	Features	Tool Types
3M™ Hookit™ II Disc Pads					
051131-05270	3"	5	15,000	<ul style="list-style-type: none"> Designed for use with 3" 3M™ Imperial™ Hookit™ II Discs 	All 3" D/A sanders
Primer Pads					
051131-05251	6"	10	12,000	<ul style="list-style-type: none"> Designed for 3M™ Hookit™ II Discs Tough, durable plastic and conformable foam body 	Slow speed sander/polisher with 5/8" shaft
051131-05275	5"	10	12,000	<ul style="list-style-type: none"> Designed for sanding primer 	
Bodyman Pads					
051131-05276	6"	10	12,000	<ul style="list-style-type: none"> Designed for sanding plastic filler and rough featheredging paint 	
051131-05279	8"	1	1,500		
Painter Pad					
051131-05286	6"	10	12,000	<ul style="list-style-type: none"> Designed for fine featheredging paint and sanding primer Use with 3M™ Hookit™ II Soft Interface Pad (PN05274) for primer, clear coats and paint finishing 	
3M™ Hookit™ II 8" Replacement Disc Pads					
051131-05280*		1	1,500	<ul style="list-style-type: none"> Designed for 8" 3M™ Hookit™ II Discs Lightweight, durable and well-balanced 	Hutchins Eliminator National Detroit 900
051131-05281 (For tools with 5 mounting holes)		1	1,500		
051131-05282 (For tools with 6 mounting holes)		1	1,500		Chicago Pneumatic 777
051131-05283 (For tools with 6 mounting holes)		1	1,500		Snap-On PS-200

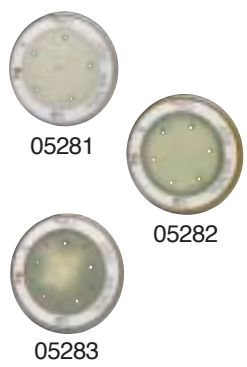

*To order call VLR at 1-800-843-0619 or access website at www.cmprovhi.com

3M Abrasive Accessories

3M™ Hookit™ and 3M™ Hookit™ II 3", 5", 6" & 8" Disc Pads (continued)

Part Number	Size	Qty./ Case	Max RPM	Features	Tool Types
3M™ Hookit™ 8" Disc Pads (for Gear Driven 8" Sanders)					
051131- 05781 (For tools with 5 mounting holes)		1	1,500	<ul style="list-style-type: none"> • Designed for 8" 3M™ Hookit™ Discs • Low profile design • Bolt on construction 	See reference chart on page 59.
051131- 05782 (For tools with 6 mounting holes)		1	1,500		
051131- 05783* (For tools with 6 mounting holes)		1	1,500		
*To order call VLR at 1-800-843-0619 or access website at www.cmprovhi.com					
3M™ Hookit™ II Soft Interface Pads					
051131- 05271	3"	10	15,000	<ul style="list-style-type: none"> • Designed for 3M™ Hookit™ II Discs • Improves abrasive cut and finish • Reduces vibration 	Dual Action and Random Orbital sanders using 3M™ Hookit™ II Disc Pads
051131- 05273	5"	10	12,000		
051131- 05274	6"	10	12,000		
3M™ Hookit™ Soft Interface Pads (Fine Grade Abrasives — P320–P1500)					
051131- 05771	3"	10	15,000	<ul style="list-style-type: none"> • Designed for 3M™ Hookit™ Discs • Improves abrasive cut and finish • Reduces vibration 	Dual Action and Random Orbital sanders using 3M™ Hookit™ Disc Pads
051131- 05773	5"	10	12,000		
051131- 05774	6"	10	12,000		
3M™ Hookit™ II Hand Pad					
051131- 05291	6"	20		<ul style="list-style-type: none"> • Designed for 3M™ Hookit™ II Discs • Strap holds pad on hand • Soft foam rubber spreads out sanding pressure 	
3M™ Hookit™ Hand Pad					
051131- 05791	6"	20		<ul style="list-style-type: none"> • Designed for 3M™ Hookit™ Discs • Strap holds pad on hand • Soft foam rubber spreads out sanding pressure 	
3M™ Hookit™ II Half Round Soft Hand Pad					
051131- 05292	6"	20		<ul style="list-style-type: none"> • Designed for 3M™ Hookit™ II Discs • Straight and curved edge • Very good support for leveling 	
3M™ Hookit™ Half Round Pad					
051131- 05792	6"	20		<ul style="list-style-type: none"> • Designed for 3M™ Hookit™ Discs • Straight and curved edge • Very good support for leveling 	

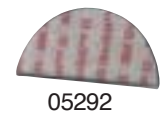
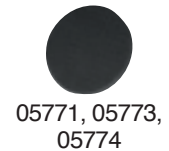
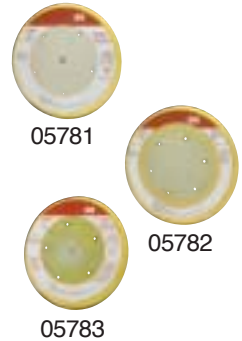

3M Abrasive Accessories





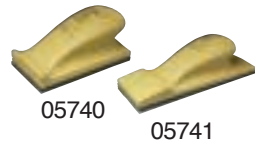
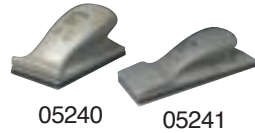

3M™ Hookit™ and 3M™ Hookit™ II Sheet — Hand Accessories

Part Number	Size	Qty./Case	Features
3M™ Hookit™ II Hand Blocks			
051131-05240	2-3/4" x 5"	10	<ul style="list-style-type: none"> • Designed for 3M™ Hookit™ II Sheets • Fits the hand — durable • Produces a true flat surface
051131-05241	2-3/4" x 7-3/4"	10	
3M™ Hookit™ Hand Blocks			
051131-05740	2-3/4" x 5"	10	<ul style="list-style-type: none"> • Designed for 3M™ Hookit™ Regalite™ Sheets • Fits the hand — durable • Produces a true flat surface
051131-05741	2-3/4" x 7-3/4"	10	
3M™ Hookit™ II Soft Hand Block			
051131-05242	2-3/4" x 5"	10	<ul style="list-style-type: none"> • Designed for 3M™ Hookit™ II Sheets • Durable foam — enables contour and flat sanding • Shaped to fit the hand
3M™ Hookit™ Soft Hand Block			
051131-05742	2-3/4" x 5"	1	<ul style="list-style-type: none"> • Designed for 3M™ Hookit™ Sheets • Durable foam — enables contour and flat sanding • Shaped to fit the hand
3M™ Hookit™ II Hand File Board			
051131-05244	2-3/4" x 16"	1	<ul style="list-style-type: none"> • Designed for 3M™ Hookit™ II Sheets • Durable with 3 handles • Produces a true flat surface
3M™ Hookit™ Hand File Board			
051131-05744	2-3/4" x 16"	1	<ul style="list-style-type: none"> • Designed for 3M™ Hookit™ Regalite™ Sheets • Durable with 3 handles • Produces a true flat surface



3M Abrasive Accessories

3M™ Imperial™ Hookit™ II, 3M™ Hookit™ II, 3M™ Hookit™ and 3M™ Stikit™ Accessories

Part Number	Size	Qty./ Case	Features	Tool Types	
3M™ Hookit™ II Air File Shoe					
051131-05248	2-3/4" x 16"	5	<ul style="list-style-type: none"> Designed for 3M™ Hookit™ II Sheets Excellent support, produces a true flat surface Durable rubber face 	Fits standard straight line air files with 2 bolts	 <p style="text-align: center;">05248</p>
3M™ Imperial™ Hookit™ II Air File Shoe					
051131-05250	2-3/4" x 11"	5	<ul style="list-style-type: none"> Designed for the Viking V101 mini type straight line air file with 3M™ Imperial™ Hookit™ II File Sheets Allows for easy attachment and removal, eliminating the need for mechanical clips 	Fits standard straight line air files with 2 bolts	 <p style="text-align: center;">05250</p>
3M™ Hookit™ Orbital Air File Shoe					
051131-05746*	2-3/4" x 16-1/2"	5	<ul style="list-style-type: none"> Features a tuck-in clip for easy insertion and application of 3M™ Hookit™ Regalite™ sheets to the pad face 	Designed for use on Hutchins, Rodac and Chicago Pneumatic Orbital Air Files	 <p style="text-align: center;">05746</p>
*To order call VLR at 1-800-843-0619 or access website at www.cmprovhi.com					
3M™ Hookit™ Air File Shoe					
051131-05748	2-3/4" x 16-1/2"	5	<ul style="list-style-type: none"> Specially designed for use on all straight air files with 3M™ Hookit™ Regalite™ File Sheets Allows for easy attachment and removal, eliminating the need for mechanical clips 	Fits standard straight line air files with 2 bolts	 <p style="text-align: center;">05748</p>
3M™ Hookit™ Straight Line Air File Shoe					
051131-05750*	2-3/4" x 11"	5	<ul style="list-style-type: none"> Designed for the Viking V101 mini type straight line air file with 3M™ Green Corps™ Hookit™ Regalite™ File Sheets Allows for easy attachment and removal, eliminating the need for mechanical clips 	Fits standard straight line air files with 2 bolts	 <p style="text-align: center;">05750</p>
*To order call VLR at 1-800-843-0619 or access website at www.cmprovhi.com					
3M™ Stikit™ Orbital Air File Shoe					
051144-05446*	2-3/4" x 16-1/2"	10	<ul style="list-style-type: none"> Features a tuck-in clip for easy insertion and quick application of file sheets plus the elimination of mechanical clips 	Designed for use on Hutchins, Rodac and Chicago Pneumatic Orbital Air Files	 <p style="text-align: center;">05446</p>
*To order call VLR at 1-800-843-0619 or access website at www.cmprovhi.com					

3M Abrasive Accessories

3M™ Imperial™ Hookit™ II, 3M™ Hookit™ II, 3M™ Hookit™ and 3M™ Stikit™ Accessories Dust-Free

Part Number	Disc Size	Qty./ Case	Max RPM	Features	Tool Types
-------------	-----------	------------	---------	----------	------------

3M™ Hookit™ II Straight Line Air File Shoe Dust-Free

051131- 05348*	2-3/4" X 16"	5		<ul style="list-style-type: none"> • Features a tuck-in clip for easy insertion and application of 3M™ Imperial™ Hookit™ sheets to the pad face 	Fits standard straight air files
-----------------------	--------------	---	--	--	----------------------------------

*To order call VLR at 1-800-843-0619 or access website at www.cmprovhi.com

3M™ Hookit™ II Primer Finishing Pad Dust-Free

051131- 05351	6"	10	12,000	<ul style="list-style-type: none"> • For 3M™ Hookit™ II Discs Dust-Free 	Dual Action and Random Orbital vacuum sanders
----------------------	----	----	--------	--	---

3M™ Hookit™ Low Profile Backup Pad Dust-Free

051131- 05355	5"	10	10,000	<ul style="list-style-type: none"> • For 3M™ Imperial™ Hookit™ II Discs Dust-Free 	Dual Action and Random Orbital vacuum sanders
051131- 05356**	6"	10	10,000		
051131- 05357*	6"	10	10,000		

051131-**05855** 5" 10 10,000
 051131-**05856** 6" 10 10,000
 (For tools with standard 6-hole pattern)

*To order call VLR at 1-800-843-0619 or access website at www.cmprovhi.com

**Dust-free pad, PN05356, is standard hardness but low profile.

3M™ Hookit™ II Disc Pads Dust-Free

051131- 05380*	8"	1	1,500	<ul style="list-style-type: none"> • For 3M™ Imperial™ Hookit™ II Discs Dust-Free 	Hutchins Eliminator Model 2001VA
-----------------------	----	---	-------	--	----------------------------------

051131-**05381** 8" 1 1,500
 (For sanders with 5 pad face attachment screws) • Lightweight, durable and well-balanced
 See reference chart on page 59.

051131-**05382*** 8" 1 1,500
 (For sanders with 6 pad face attachment screws) See reference chart on page 59.

*To order call VLR at 1-800-843-0619 or access website at www.cmprovhi.com



05351



05355



05356



05855



05856



05357



05380







05381



05382

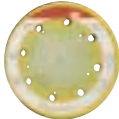



3M Abrasive Accessories

3M™ Imperial™ Hookit™ II, 3M™ Hookit™ II, 3M™ Hookit™ and 3M™ Stikit™ Accessories Dust-Free

Part Number	Disc Size	Qty./Case	Max RPM	Features	Tool Types
3M™ Hookit™ Straight Line Air File Shoe Dust-Free					
051131-05848*	2-3/4" X 16"	5		<ul style="list-style-type: none"> For 3M™ Green Corps™ Hookit™ Regalite™ File Sheets Dust-Free Easy attachment and removal of sheets 	Specially designed for use on all straight air files  05848
*To order call VLR at 1-800-843-0619 or access website at www.cmprovhi.com					
3M™ Hookit™ 8" Replacement Disc Pad Dust-Free (for 8" Gear Driven Sanders)					
051131-05881 (For tools with 5 mounting holes)		1	1,500	<ul style="list-style-type: none"> For 3M™ Hookit™ Discs Dust-Free Low profile design 	See reference chart on page 59.  05881
3M™ Stikit™ Low Profile Finishing Disc Pad Dust-Free					
051131-05646	6"	10	12,000	<ul style="list-style-type: none"> For 3M™ Stikit™ Gold Discs Dust-Free 	Random Orbital sanders only  05646
3M™ Stikit™ Low Profile Finishing Disc Pads Dust-Free					
051131-05655	5"	10	10,000	<ul style="list-style-type: none"> For 3M™ Stikit™ Discs Dust-Free 	Dual Action and Random Orbital vacuum sanders  05655
051131-05656	6"	10	10,000	<ul style="list-style-type: none"> Standard 6-hole pattern 	Random Orbital vacuum sanders  05656
3M™ Stikit™ 8" Replacement Disc Pad Dust-Free (for 8" Gear Driven Sanders)					
051131-05681*		1	1,500	<ul style="list-style-type: none"> For 3M™ Stikit™ Discs Dust-Free 	See reference chart on page 59.  05681
*To order call VLR at 1-800-843-0619 or access website at www.cmprovhi.com					

3M Abrasive Accessories

3M™ Grinding Disc Accessories

Part Number	Size	Qty./Case	Max RPM	Features	Tool Types
3M™ Kut-Down Disc Adapters					
051131- 05533	3" Dia. 1/4" Dia. Shaft	10 (2 adapters/pack)		<ul style="list-style-type: none"> Attaches directly to 3M™ Kut-Down™ discs (PNs 01429, 01430 and 01431) Easy-on/easy-off for quick change of disc 	One adapter for use with hand-held pneumatic grinders (7/16" —20 thread) and a 1/4" hex mandrel for use with automotive drill
					
05533					
3M™ Roloc™ Disc Pad Assembly					
051131- 05538	1" Dia. 1/4" Dia. Shaft	10	30,000	<ul style="list-style-type: none"> Includes Roloc™ Adapter 7/16" — 24 thread Hard rubber backup pad Firm support for Scotch-Brite™ Roloc™ Surface Conditioning Discs (PNs 07480–07516) and Scotch-Brite™ Roloc™ Bristle Discs (PNs 07524–07532) 	Adapts to most air and electric tools
051144- 05539	2" Dia. 1/4" Dia. Shaft	10	25,000		
051144- 05540	3" Dia. 1/4" Dia. Shaft	10	20,000		
051131- 05541	4" Dia. 1/4" Dia. Shaft	10	12,000		
					
05538, 05539, 05540, 05541					
3M™ Hub and Retainer Nut for 3M™ Fibre Grinding Disc Pads					
051131- 05632 *	Retainer Nut	10		<ul style="list-style-type: none"> Fits standard (5/8" shaft) grinders 	
051144- 05633 *	Hub and Retainer Nut	1			
*To order call VLR at 1-800-843-0619 or access website at www.cmprovhi.com					
3M™ Fibre Disc Backup Pad					
051144- 05634	7" Dia.	10	6,000	<ul style="list-style-type: none"> Firm support for grinding discs Conforms to surface contours Quick change from 7" to 9-1/8" 	
					
05634					
3M™ Fibre Disc Backup Pad					
051131- 05637	5" Dia.	10	18,000	<ul style="list-style-type: none"> Firm support for 5" 3M™ Fibre Discs (PNs 01913–01916) Conforms to surface contours Hard rubber backup pad Designed to resist chunking 	
					
05637					

3M Abrasive Accessories

3M™ Glue On Sanding Disc Accessories

Part Number	Size	Qty./ Case	Max RPM	Features	Tool Types
-------------	------	------------	---------	----------	------------

3M™ Disc Pads

051144-05577	5"	10	7,000	<ul style="list-style-type: none"> • For use with 3M™ Feathering Disc Adhesive (PN08051) • Cloth face — excellent Feathering Disc Adhesive bonding • Tough, durable construction • Tapered edge design • Fits all standard (5/8" shaft) slow-speed polishers 	Dual Action & Random Orbital
051144-05578	6"	10	7,000		



05577

05578

3M™ Wetordry™ and Dry Sandpaper Accessories

Part Number	Size	Qty./ Case	Features
-------------	------	------------	----------

3M™ Rubber Sanding Block 5"

051144-05519	2-3/4" x 5"	10	<ul style="list-style-type: none"> • Durable rubber sanding block • Slotted ends for holding sheets during wet or dry sanding • Generates a true flat surface for blocking • Conforms to body contours • Designed to be used with 2-3/4" x 9" sheets
--------------	-------------	----	---



05519

3M™ Rubber Sanding Block 8"

051131-05520	3" x 8"	10	<ul style="list-style-type: none"> • For use with 3M™ Wetordry™ and dry sanding sheets • Excellent for blocking, pliable for sanding mild contours • Designed to hold 3" x 11" sheets (9" x 11" sheets folded into thirds) securely during wet or dry sanding operations
--------------	---------	----	---



05520

3M™ Wetordry™ Sponge Pad No. 20

051131-05526	2-3/4" x 5-1/2"	50	<ul style="list-style-type: none"> • A firm hand sanding pad • Excellent for supporting a half sheet of 3M™ Wetordry™ or dry sanding sheet wrapped around the pad • Can use both sides • Dip entire sheet and pad into bucket for wet sanding
--------------	-----------------	----	---



05526

3M™ Stikit™ Soft Hand Pad

051144-05530	2-3/4" x 5-1/2"	50	<ul style="list-style-type: none"> • For use with 3M™ Stikit™ Tri-M-ite™ Sheet Rolls and 3M™ Imperial™ Color Sanding Paper Sheets • Eliminates finger marks and edge cutting into primer while providing a soft controlled touch • Excellent conformability; ideal for light scuff sanding
--------------	-----------------	----	---



05530

3M Abrasive Accessories

Miscellaneous

Part Number	Size	Qty./ Case	Features
-------------	------	------------	----------

3M™ Abrasive Organizer

051131-02500		1	<ul style="list-style-type: none"> • 13 adjustable shelves, 1 permanent shelf • Two hinged doors with clasp for locking up materials • Red in color with a white 3M logo on the door • Dimensions: 32-5/8" W x 12-1/8" D x 30-1/16" H • Weighs 54 lbs. • NOTE: PRODUCTS ARE NOT INCLUDED WITH ORGANIZER.
--------------	--	---	---



02500

3M™ Wetordry™ Bucket

051131-02513		10	<ul style="list-style-type: none"> • A durable rubber bucket • Designed for use when wet sanding • Each bucket has a tray packed inside to store 3M™ Wetordry™ paper, squeegees and blocks
--------------	--	----	---



02513

3M™ Wetordry™ Rubber Squeegees

051144-05517	2-3/4" x 4-1/2"	50	<ul style="list-style-type: none"> • Made of flexible rubber • 3" x 2" for removing sanding swarf and water from wet sanding
051144-05518	3" x 2"	50	<ul style="list-style-type: none"> • 2-3/4" x 4-1/2" for applying 2K body filler and glazing putty



05517

3M™ Stikit™ Disc Roll Dispenser

051144-05450		1	<ul style="list-style-type: none"> • Stores, carries and dispenses two rolls of 5" or 6" 3M™ Stikit™ Discs simultaneously • Fast, easy one-handed dispensing of a single disc • Lightweight, easy to carry — no moving parts, can see disc supply at a glance • NOTE: DISCS ARE NOT INCLUDED WITH THE DISPENSER.
--------------	--	---	---



05450

3M™ Stikit™ 75 Disc Roll Dispenser

051131-05451*		1	
---------------	--	---	--

*To order call VLR at 1-800-843-0619 or access website at www.cmprovh.com



05451

3M™ Stikit™ Double Roll Dispenser

051144-05452		1	<ul style="list-style-type: none"> • Holds two 3M™ Stikit™ Sheet Rolls for quick, easy dispensing • Keeps abrasive flat while protecting the adhesive backing • Enables technician to tear off desired length for each job • NOTE: ROLLS ARE NOT INCLUDED WITH THE DISPENSER.
--------------	--	---	--



05452

3M Abrasive Accessories/Sanding Tools — Reference Guide for R/O (Random Orbital) and D/A (Dual Action) Sanders

Tool Company	Size 6" Model Number	Type/Name	3M™ REPLACEMENT PADS—6"					
			3M™ Stikit™	3M™ Stikit™ Dust-Free	3M™ Hookit™	3M™ Hookit™ Dust-Free	3M™ Hookit™ II	3M™ Hookit™ II Dust-Free
Astro	303	R/O	05576		05776		05276	
	300T	R/O	05576		05776		05276	
Blue Dart	855	R/O	05576		05776		05276	
Chicago Pneumatic	CP-864, 870 & 890	Heavy-Duty R/O and Standard D/A	05576		05776		05276	
	CP-760, 761, 760P & 761P	R/O Dust-Free Sanding		05656		05856		05356
Dynabrade	10326	R/O	05556		05776		05276	
	10330	R/O Dust-Free		05656		05856		05356
	10329	R/O	05556		05756		05276	
	10424 10510	R/O Dust-Free Gear Driven	N/A	05656		05856		05356 05357*
FL Pneumatic	FP888	R/O	05576		05776		05276	
	FP889	R/O	05576		05776		05276	
	R915	R/O	05576		05776		05276	
Hutchins	3500	R/O	05576		05776		05276	
	4500	R/O	05576		05776		05276	
	4500-VA	R/O		05656		05856		05356
	4560	R/O	05576		05776		05276	
	2006	Rotary	05576		05776		05276	
Ingersol-Rand	IR310	R/O	05576		05776		05276	
	IR311	R/O	05576		05776		05276	
	IR351	R/O	05576		05776		05276	
	IR352	R/O	05576		05776		05276	
	IR354	R/O Dust-Free		05656		05856		05356
	IR355	R/O Dust-Free		05656		05856		05356
MAC Tool	IR3151	R/O	05576		05776		05276	
	AS4500	R/O	05576		05776		05276	
	AS155	R/O	05576		05776		05276	
	ASDAI	D/A	05556		05756		05276	
NAPA	NPT888	R/O	05576		05776		05276	
	NPT889	R/O	05576		05776		05276	
	NPT876	Palm Grip R/O	05576		05776		05276	
	NP-8800	Triple Action	05576		05776		05276	
	National-Detroit	D/A	D/A	05556		05756		05276
DA-DE		D/A		05656		05856		05356
DA-Q		D/A	05576		05776		05276	
DAQ-DE		D/A		05656		05856		05356
EZ-Q and EZLS		D/A	05576		05776		05276	
EZ-Q-DE and EZLS-DE		D/A		05656		05856		05356
9600 PG-6		Gear Driven D/A		N/A				05357* 05366
Rockford Tool	ASN300	R/O			05776		05276	
	ASN305	R/O			05776		05276	
Sioux	5558A	R/O	05576		05776		05276	
	760	R/O	05576		05776		05276	
	797V	R/O		05656				
	760VAC	R/O						
Snap-On	AT400A	R/O	05576		05776		05276	
	PS100	R/O	05576		05776		05276	
	PS100V	R/O		05656		05856		05356
Viking	V200	R/O	05576		05776		05276	
	V200 Dust-Free	R/O		05656				05356

*To order call VLR at 1-800-843-0619 or access website at www.cmprovhi.com

N/A = None Available

3M Abrasive Accessories/Sanding Tools — Reference Guide for Straight Line and Orbital Air Files

Tool Company	Model Number	Type	3M™ Stikit™ Shoe	3M™ Stikit™ Dust-Free	3M™ Hookit™	3M™ Hookit™ Dust-Free	3M™ Hookit™ II	3M™ Hookit™ II Dust-Free	
Acme Tool	7625	Str. Line	05448		05748		05248		
Astro	888C	Str. Line	05448		05748		05248		
Chicago Pneumatic	CP767	Str. Line	05448		05748		05248		
	CP768	Str. Line	05448		05748		05248		
	CP877	Str. Line	05448		05748		05248		
Desoutter	389	Str. Line	05448		05748		05248		
	322	Orbital	N/A		N/A		N/A		
FL Pneumatic	8222A	Str. Line	05448		05748		05248		
	R905	Str. Line	05448		05748		05248		
Hutchins	3800 and 8000 4932 VA/DF 2000 Hustler 2000 HustlerVA/DF	Orbital Orbital Str. Line Str. Line	Recommend Hutchins Pad. Please call Hutchins at (626) 792-8211 for the proper tool.						
Ingersol-Rand	315	Str. Line	05448		05748		05248		
MAC Tool	ASD1	Str. Line	05448		05748		05248		
	AS315	Str. Line	05448		05748		05248		
	AS800	Orbital					05246		
	ASD2	Str. Line - "Mini"					05250		
NAPA	NPT822A	Str. Line	05448		05748		05248		
National-Detroit	FB8	Orbital	N/A		N/A		N/A		
Rockford Tool	ASN392	Str. Line	05448		05748		05248		
	ASN396	Str. Line	05448		05748		05248		
Rodac	R8800	Str. Line	05448		05748		05248		
Snap-On	AT475A	Str. Line	05448		05748		05248		
Universal	UP5600	Str. Line	05448		05748		05248		
Viking	V-100	Str. Line	05448		05748		05248		
	V-101	Mini Str. Line	N/A		05750*		05250		

*To order call VLR at 1-800-843-0619 or access website at www.cmprovhi.com

N/A = None Available

3M Abrasive Accessories/Sanding Tools — Reference Guide for Gear Driven 8" Sanders

Tool Company	Model Number	Type	3M™ Stikit™	3M™ Stikit™ Dust-Free	3M™ Hookit™	3M™ Hookit™ Dust-Free	3M™ Hookit™ II	3M™ Hookit™ II Dust-Free
Astro	AP308	Orbital	05582		05782		05282	
Chicago Pneumatic	777	Orbital	05582		05782		05282	
Desoutter	390 390-DE	Gear-Dual Drive Gear-Dual Drive	05581	05681*	05781	05881	05281	05381
Dynabrade	10600 & 10700	Orbital	05582		05782		05282	
FL Pneumatic	FP8870-8 R-917	Orbital Orbital	05582 05582		05782 05782		05282 05282	05382*
Hutchins	2001	Orbital		N/A		N/A		05380*
Ingersol-Rand	328	Orbital	05582		05782		05282	
MAC Tool	A-SDF1	Orbital	05582		05782		05282	
NAPA	NPT888	Orbital	05582		05782		05282	
NAPA	8870-8	Orbital	05582		05782		05282	
National-Detroit	900 900DE	Orbital Orbital	05581		05781	05881	05281	05381
Rockford Tool	ASN308	Orbital	05582		05782		05282	
Snap-On	PS200	Orbital					05283	
Universal	UP5711	Orbital	05582		05782		05282	
Viking	V201	Orbital	05582		05782		05282	

*To order call VLR at 1-800-843-0619 or access website at www.cmprovhi.com

N/A = None Available

3M Abrasive Accessories/Sanding Tools — Reference Guide for Specialty Tools

Tool Company	Model Number	Name/Type	Pad Size	3M™ Stikit™	3M™ Stikit™ Dust-Free	3M™ Hookit™	3M™ Hookit™ Dust-Free	Tool Company Contacts
B&D	4011	Palm Oscillating	6"	40176		N/A	N/A	
	6160		6"	40176		N/A	N/A	
DeWalt	4112	Palm Oscillating	6"	DW4112		N/A	N/A	
Dynabrade	10104	Dynabug	3-2/3" x 7"	N/A		N/A		Jeff Gurbacki 716-631-0100, x138 Bill Koslowski 716-631-0100, x110 www.dynabrade.com/auto autoast@dynabrade.com
Hutchins	2024	Hustler II Str. Line	3-2/3" x 7"	2024	Hutchins 8624	2024-H	8624-H	Alme Hutchins 626-792-8211 www.hutchinsmfg.com
	8624	Hustler II D/F Str. Line	3-2/3" x 7"					
MAC Tool	AFS2	Mini Str. Line	2-3/4" x 11"					
National-Detroit	1100	Str. Line	2-3/4" x 8-1/4"		National-Detroit 8893		National-Detroit 8877	Gary Swanson 815-877-4041 www.NationalDetroit.com
	2200	Orbital	2-3/4" x 8-1/4"		National-Detroit 8890		National-Detroit 8877	
Viking	V101	Str. Line	2-3/4" x 11"	N/A				Ernie Torkilsen 847-362-1122 www.vikingindustriesllc.com

Manufacturer's part numbers are listed where 3M Stikit™ and Hookit™ accessories are not available. Contact manufacturer for samples.

N/A = None Available

3M Job-Packed Abrasives

3M™ Professional Job-Packed Abrasives

- 3M™ Professional Abrasives now available in smaller, job-size quantities.
- For the jobber: No need to open boxes to sell single sheets. Easier to display inventory and to sell.
- For the user: No need to buy full boxes to get the professional quality product. Buying by the pack makes it easier to buy, easier to store and reduces inventory costs.
- To convert the job-packed part number to the bulk-packed part number, simply substitute a "0" for the "3" at the beginning of the 5-digit part number. Exceptions are PNs 31509, 31510, 31511, 31512, 31519, 31520, 31521, 31522, 32568 and 32569.

3M™ Green Corps™ Roloc™ Discs

- The versatility of 3M™ Roloc™ with the premium quality of 3M™ Green Corps™.
- Handy quick change tool for disc grinding which fits any standard 1/4" drill or air tool.
- Quick 1/2 turn on, 1/2 turn off speeds disc changing and cuts down time.
- Color-coded.

Part Number	Grade	Discs Per Pack	Packs Per Case
3" Diameter			
051131- 31407	36	5	10
051131- 31408	24	5	10

3M™ Stikit™ Gold Discs

- Durable and longer lasting disc product.
- Available in "A" weight in a full range of grades.
- Discs have a pressure-sensitive adhesive for easy application and removal.



Part Number	Grade	Discs Per Pack	Packs Per Case
6" Diameter			
051131- 31434	P400	5	10
051131- 31435	P320	5	10
051131- 31437	P240	5	10
051131- 31438	P220	5	10
051131- 31439	P180	5	10
051131- 31440	P150	5	10
051131- 31441	P120	5	10
051131- 31442	P100	5	10
051131- 31443	P80	5	10
6" Diameter			
051131- 31512	P80	12	4
6" Diameter			
051131- 31519	P320	25	4
051131- 31520	P220	25	4
051131- 31521	P180	25	4
051131- 31522	P80	25	4

3M™ Stikit™ Green Fre-Cut™ Discs

- A more durable and longer lasting disc product.
- Pressure-sensitive adhesive backing for easy application.
- Come in roll form for easy dispensing from our 3M™ Stikit™ Disc Roll Dispenser (PN05450).

Part Number	Grade	Discs Per Pack	Packs Per Case
6" Diameter			
051131- 31506	80D	5	10

3M™ Green Corps™ Stikit™ Production™ Discs

- Pressure-sensitive adhesive backed.
- Tough mineral/bond construction.
- Tough "E" weight backing.
- Fast-cutting, long-lasting.
- Resists loading.



Part Number	Grade	Discs Per Pack	Packs Per Case
6" Diameter			
051131- 31547	40E	5	10
051131- 31548	36E	5	10
8" Diameter			
051131- 31549 †	80D	5	10
051131- 31550	40E	5	10
051131- 31551	36E	5	10

† 3M™ Fre-Cut™ Disc

3M Job-Packed Abrasives

3M™ Green Corps™ Fibre Discs

- All-purpose grinding discs for door skinning, grinding MIG welds or any kind of metal grinding.
- High-performance grinding discs.
- Long-lasting and fast-cutting.

Part Number	Grade	Discs Per Pack	Packs Per Case
5" x 7/8"			
051131-31914	36	2	10
051131-31915	24	2	10
7" x 7/8"			
051131-31922	36	2	10
051131-31923	24	2	10

3M™ Green Corps™ Cut-Off Wheels

- High-performance, long-lived cut-off wheel.
- Used for cutting auto body sheet metal, frame rails, clamps and rusted bolts.
- For use on utility type cut-off tools.

NOTE: Read all warnings supplied with wheels. Do not use on tool without guards.

Part Number	Size	Wheels Per Pack	Packs Per Case
Peggable Package			
051131-31990	3" x 1/16" x 3/8"	1	10

3M™ Wetordry™ Paper Sheets

- Use wet with water or dry for sanding old finishes, fine featheredging and surface sanding.
- 3M™ Wetordry™ stays flexible and cuts fast.

Part Number	Grade	Sheets Per Pack	Packs Per Case
9" x 11"			
051131-32015	150C	3	10

3M™ Imperial™ Wetordry™ Paper Sheets

- Designed for light sanding prior to compounding.
- Sheet size eliminates the need of tearing — entire sheet can be used.
- Durable backing resists tearing and wrinkling.



Part Number	Grade	Sheets Per Pack	Packs Per Case
9" x 11"			
051131-32021	Ultra Fine 1000	5	10
051131-32022	Micro Fine 1200	5	10
051131-32023	Micro Fine 1500	5	10
051131-32044	Micro Fine 2000	5	10

3M™ Imperial™ Wetordry™ Paper Sheets

- Premium, aluminum oxide mineral, an improved paper backing and an optimized construction.
- Performance advantages: Improved rate of cut, increased abrasive life, increased flexibility, and uniform, consistent finish.



Part Number	Grade	Sheets Per Pack	Packs Per Case
9" x 11"			
051131-32035	P800	5	10
051131-32036	P600	5	10
051131-32037	P500	5	10
051131-32038	P400	5	10
051131-32039	P360	5	10
051131-32040	P320	5	10
051131-32042	P240	5	10
051131-32043	P220	5	10

3M™ Production™ Paper Sheets (Open Coat)

- Dry sanding only on machine or by hand.
- Open coat resists loading.
- Works well for shaping and finishing plastic filler and featheredging.



Part Number	Grade	Sheets Per Pack	Packs Per Case
9" x 11"			
051131-32115	80D	5	10
051131-32118	40D	5	10

3M™ Green Corps™ Production™ Resin Paper Sheets

- Dry sanding only with hand file or air file.
- Unique mineral coating.
- Long-lasting, fast-cutting.
- Excellent for sanding plastic filler and for featheredging.

Part Number	Grade	Sheets Per Pack	Packs Per Case
2-3/4" x 17-1/2"			
051131-32220 †	80D	5	10
051131-32221	40E	5	10
051131-32222	36E	5	10

† 3M™ Fre-Cut™ Sheets

3M Job-Packed Abrasives

3M™ Green Corps™ Stikit™ Production™ Sheets

- Pressure-sensitive adhesive backing.
- Unique mineral coating.
- Long-lasting, fast-cutting abrasive life.

Part Number	Grade	Sheets Per Pack	Packs Per Case
2-3/4" x 16-1/2"			
051131- 32230 †	80D	5	10
051131- 32231	40E	5	10
051131- 32232	36E	5	10

† 3M™ Fre-Cut™ Sheet

3M™ Production™ Resinite™ Fre-Cut™ Gold Paper Sheets

- Utilizes a premium, aluminum oxide mineral and an improved paper backing and total construction.
- Performance advantages: Improved rate of cut, increased flexibility, increased abrasive life and uniform, consistent finish.



Part Number	Grade	Sheets Per Pack	Packs Per Case
9" x 11"			
051131- 32541	P320	5	10
051131- 32544	P220	5	10
051131- 32545	P180	5	10
2-3/4" x 17-1/2"			
051131- 32568	P180	5	10
051131- 32569	P150	5	10

3M Job-Packed Abrasives Accessories

3M™ Rubber Sanding Block

- For use with 3M™ Wetordry™ and dry 9" x 11" sanding sheets for block sanding.
- Pliable rubber block for mild contours.
- Eliminates highlights in work from finger pressure.
- Designed to hold sandpaper sheets securely during wet or dry sanding operations.
- 2-3/4" x 5" block utilizes a 9" x 11" sheet torn or folded into fourths to make 2-3/4" x 9" sheets or for convenience use 3M pre-cut 2-3/4" x 9" sheets.

Part Number	Block Size	Quantity Per Pack	Packs Per Case
Peggable Package			
051131- 35519	2-3/4" x 5"	1	5

3M™ Roloc™ Disc Pad Assembly

- Hard rubber backup pad.
- Provides firm support for Scotch-Brite™ Roloc™ Surface Conditioning Discs. (PNs 07480-07514).
- Pad assemblies come complete with a 2" steel shaft and adapter.

Part Number	Diameter	Assemblies Per Pack	Packs Per Case
Peggable Package			
051131- 35540	3"	1	5

3M™ Stikit™ Disc Pad

- Specially made for use with 3M™ Stikit™ Discs.
- Vinyl pad face provides good disc adhesion yet allows easy disc removal.
- Both pads are lightweight, shock resistant and well-balanced.
- Made with a tough, durable plastic hub and a conformable foam "body".
- Maximum operating speed for 5" and 6" pads — 10000 RPM.

Part Number	For Use With Disc Size	Pads Per Case
Peggable Package — 1 Pad Per Pack		
051131- 35576	6" diameter	5

3M Job-Packed Hand Pads

Scotch-Brite™ General Purpose Pad Maroon

- For scuffing before applying paint and primer-surfacer.
- For used car reconditioning, cleaning upholstery, headliners, doorpads, chrome and cleaning of white wall tires.
- Made of nylon web.
- Rinse clean.
- Can be used over and over again.

Part Number	Pads Per Pack	Packs Per Case
051131- 37447	3	10

Scotch-Brite™ Ultra Fine Pad Gray

- For final sanding of primer-surfacer.
- Made of nylon web.
- Rinse clean.
- Can be used over and over again.

Part Number	Pads Per Pack	Packs Per Case
051131- 37448	3	10

3M Retail Abrasives and Accessories Products

3M™ Imperial™ Wetordry™ Base Coat/Clear Coat Finishing Paper

- Ideal for final sanding of enamel/urethane refinish or factory applied paints.
- 3M™ Wetordry™ silicone carbide mineral construction.

Part Number	Grade	Size	Sheets Per Pack	Packs Per Case
051131-03001	1000	3-2/3" x 9"	5	40
051131-03002	1500	3-2/3" x 9"	5	40
051131-03003	2000	3-2/3" x 9"	5	40
051131-03012	1500	5-1/2" x 9"	4	20

3M™ Aluminum Oxide Automotive Sandpaper

- Ideal for hand or machine sanding.
- For use on metal, plastic, body filler and fiberglass.
- Contains sandpaper made with aluminum oxide mineral, a tough and versatile synthetic abrasive.



Part Number	Grade	Size	Sheets Per Pack	Packs Per Case
051144-03004	Fine	9" x 11"	3	40
051144-03005	Medium	9" x 11"	3	40
051144-03007	Coarse	9" x 11"	3	40
051131-03009	Assorted	9" x 11"	3	40
051144-03031	Fine	3-2/3" x 9"	6	40
051144-03035	Medium	3-2/3" x 9"	6	40
051144-03038	Coarse	3-2/3" x 9"	5	40

3M™ Imperial™ Wetordry™ Emery Cloth Sheets

- Designed for rust and corrosion removal or metal sanding.
- Cloth backing makes it strong and durable.
- For deburring and preparing metal surfaces.
- Assortment contains two sheets each: Fine, Medium and Coarse.

Part Number	Size	Sheets Per Pack	Packs Per Case
051131-03008	3-2/3" x 9"	6	40

3M™ Emery Cloth Sheets

- Designed for rust and corrosion removal or metal sanding.
- Cloth backing makes it strong and durable.
- For deburring and preparing metal surfaces.
- Assortment contains one sheet each: Fine, Medium, Coarse.



Part Number	Size	Sheets Per Pack	Packs Per Case
051144-03010	9" x 11"	3	20

3M™ Imperial™ Wetordry™ Finishing Paper

- For light sanding of acrylic lacquer paint prior to using rubbing compound.
- Effectively removes overspray, dust nibs, orange peel and other imperfections in painted surface.
- Specially designed micro fine mineral to eliminate chance of sanding through paint.
- Helps provide a higher luster finish on acrylic lacquer surfaces.



Part Number	Grade	Size	Sheets Per Pack	Packs Per Case
051144-03011	1000	5-1/2" x 9"	5	20

3M™ Silicon Carbide Wetordry™ Automotive Sandpaper

- Waterproof for wet sanding by hand.
- Excellent for sanding primed surfaces, removing orange peel, dust nibs and light sagging of the top coat.
- For use on metal, plastic, body filler and fiberglass surface.
- Assortment contains one sheet each: Ultra Fine, Super Fine, Extra Fine and Very Fine.



Part Number	Grade	Size	Sheets Per Pack	Packs Per Case
051144-03013	U. Fine (1000)	9" x 11"	4	40
051144-03015	S. Fine (P800)	9" x 11"	4	40
051144-03017	E. Fine (P400)	9" x 11"	4	40
051144-03019	V. Fine (P220)	9" x 11"	4	40
051144-03021	Assorted	9" x 11"	4	40

3M™ Imperial™ Wetordry™ Sandpaper

- Designed for today's car finishes.
- Premium, aluminum oxide mineral with an improved paper backing.
- Performance advantages: Improved rate of cut, increased abrasive life, increased flexibility and uniform consistent finish.

Part Number	Grade	Size	Sheets Per Pack	Packs Per Case
051131-03016	P320	3-2/3" x 9"	5	40
051131-03018	P400	3-2/3" x 9"	5	40
051131-03020	P600	3-2/3" x 9"	5	40
051131-03022	P800	3-2/3" x 9"	5	40
051131-03024	Assorted	3-2/3" x 9"	5	40

3M Retail Abrasives and Accessories Products

3M™ Quarter Sheet Abrasive Assortment Packs

- Custom cut for hand sanding operations.
- Just enough quantities for small jobs.
- Consumer-friendly packaging and instructions that make body repair projects easier.
- All sheets are 4-1/2" x 5-1/2".

Part Number	Description	Sheets Per Pack	Packs Per Case
051131- 03025	Silicon Carbide 3M™ Wetordry™ Sheets 1 Sheet Very Fine 240 1 Sheet Extra Fine 320 2 Sheets Super Fine 400	4	50
051131- 03026	Aluminum Oxide 1 Sheet Fine 180 2 Sheets Medium 80 1 Sheet Coarse 40	4	50

3M™ Aluminum Oxide Assortment

- Ideal for hand or machine sanding.
- For use on metal, plastic, body filler and fiberglass.
- Contains sandpaper made with aluminum oxide mineral, a tough and versatile synthetic abrasive.
- Pack contains assorted grades:
2 — 180A sheets, 2 — 80D sheets, 1 — 40D sheet.

Part Number	Size	Sheets Per Pack	Packs Per Case
051131- 03039	3-2/3" x 9"	5	40

3M™ Adhesive Backed Sanding Discs

- Adhesive backing makes sanding easy and convenient, just press the disc on the pad and sand.
- The disc peels off easily when the job is done.
- Long-lasting tough mineral, resists loading.
- Discs adhere securely to the 3M™ Disc Pad (PN03142).

Part Number	Grade	Discs Per Pack	Packs Per Case
5" Diameter			
051144- 03110	Fine	4	40
051144- 03111	Medium	4	40
051144- 03112	Coarse	3	40
6" Diameter			
051131- 03114	Fine	5	40
051131- 03115	Medium	5	40
051131- 03116	Asst. Fine and Medium	4	40

3M™ Abrasive Cloth Sanding Rolls

- Tough, flexible cloth backing for sanding hard-to-reach areas.
- Long-lasting, fast-cutting.

Part Number	Grade	Size	Rolls Per Pack	Packs Per Case
03130	Extra Fine	1" x 6'	1	10
03131	Fine	1" x 6'	1	10
051144- 03132	Medium	1" x 4-1/2'	1	10

3M™ Disc Pad

- Individually packaged flexible rubber pad with a removable center shaft.
- Sands flat or curved surfaces.
- Mounts in any tool accommodating a 1/4" shaft.



Part Number	Size	Packs Per Case
051144- 03140	5"	10

3M™ Press 'N Sand™ Disc Pad

- Provides maximum use of 3M™ Adhesive Backed Sanding Discs (PNs 03110-03112).
- Firm, but resilient for easy, uniform sanding.

Part Number	Size	Packs Per Case
051144- 03142	5"	10

3M™ Rubber Sanding Block

- Professional quality tool.
- The block is made of pliable rubber for easy, fast hand sanding.



Part Number	Size	Packs Per Case
051144- 03148	2-3/4" x 5"	10

3M™ Automotive Paint & Body Scuff Pad

- Scuff pad is designed for scuffing base, primed, or painted surfaces prior to applying primer or paint.
- Also excellent for removing light surface rust.
- Can be used wet or dry and rinses clean for repeat use.



Part Number	Size	Packs Per Case
051131- 03193	6" x 9"	20

Paint Finishing and Vehicle Appearance



Products

Body Shop Clean-Up	87–88
Buffing/Compounding Pads and Accessories	79–81, 85
Foam	80
Wool	79
Car Care Product Line	69–73
Cleaners/Conditioners	87
Detailing Products	89–91
Diluters	87–88, 91
Foam Discs and Disc Pads	82–83
Machine and Hand Applied Glazes	81–82, 85
Paint Booth Protection	69
3M™ Perfect-It™ 3000	74–78, 82, 85
Polishing Pads and Accessories	83–84
Putties	87
Retail Appearance Products	92
Rubbing Compounds	78
Scrubbers, Sponges, Wipes	86, 92
Surface Preparation	79
Waxes	86

Paint Finishing and Vehicle Appearance



3M *Innovation*

3M Paint Booth Protection

3M™ Dust Control Spray

- Designed to attract and trap dust and dirt found in paint booths.
- Creates a film which helps produce cleaner paint jobs. It is reapplied after every other car.



Part Number	Container Size	Containers Per Case
051131-06837	1 Gallon	4

3M™ Booth Coating

- Water-based liquid specifically designed to protect paint booth walls, lights, etc. from paint and primer overspray.
- Dries to a clear film.
- Can be applied with a conventional paint gun.
- Can be removed with water.



Part Number	Container Size	Containers Per Case
051131-06839	1 Gallon	4
051131-06840	5 Gallon Pail	1

3M Car Care Product Line

NOTE: VOC statements refer to products manufactured after January 1, 2005; consult local regulations.

3M™ Car Wash Shampoo

- Removes dirt and grime without removing your wax protection.
- Phosphate free.
- Clear coat safe.



Part Number	Container Size	Containers Per Case
39000*	16 oz.	6

* UPC Number is 051131-16816

3M™ Perfect-It™ II Rubbing Compound

- Our most versatile rubbing compound.
- Effectively removes grade 1200 or finer sand scratches, other fine scratches, medium oxidation, coarse swirl marks or water spots and leaves a fine finish.
- **Fine cut.**
- Excellent for hand or machine use.
- Contains no wax or silicone.
- Clear coat safe.
- VOC content less than 17%.



Part Number	Container Size	Containers Per Case
051131-39002	16 oz.	6

3M™ Imperial™ Microfinishing Rubbing Compound

- A **medium cut**, machine applied rubbing compound that effectively removes grade 1200 sand scratches, medium scratches, medium oxidation and water spots.
- Contains no wax or silicone.
- Clear coat safe.



Part Number	Container Size	Containers Per Case
051131-39001	16 oz.	6

3M™ Finesse-It™ II Finishing Material — Machine Polish

- Developed to quickly and effectively remove minor scratches producing a brilliant deep "wet look" shine.
- For best results use with machine.
- Contains no wax or silicone.
- Clear coat safe.
- VOC content less than 17%.



Part Number	Container Size	Containers Per Case
051131-39003	16 oz.	6

3M Car Care Product Line

NOTE: VOC statements refer to products manufactured after January 1, 2005; consult local regulations.

3M™ Super Duty Rubbing Compound

- A **heavy cut** (most aggressive), machine applied rubbing compound that effectively removes grade 1000 sand scratches, other coarse scratches and severe oxidation.
- Contains no wax or silicone.
- VOC content less than 17%.



Part Number	Container Size	Containers Per Case
051131-39004	16 oz.	6

3M™ One Step Cleaner Wax Light Oxidation Remover

- Removes most fine scratches, light oxidation, swirl marks and minor stains. (For medium oxidation see PN39066.)
- Leaves deep rich waxed finish.
- Excellent for hand or machine use.
- Clear coat safe.
- VOC content less than 15%.



Part Number	Container Size	Containers Per Case
051131-39006	16 oz.	6

3M™ Imperial™ Hand Glaze

- Developed using a unique combination of paint glossifiers to provide a brilliant, deep, "wet look" show car finish.
- **Show car finish.**
- Contains no wax or silicone.
- Clear coat safe.
- VOC content less than 15%.



Part Number	Container Size	Containers Per Case
051131-39007	16 oz.	6

3M™ Perfect-It™ Foam Polishing Pad Glaze Swirl Mark Remover

- Quickly removes light surface imperfections, swirl marks, light oxidation, or minor stains while producing a deep rich swirl-free finish.
- **For dark colored cars.** (For light colored cars see PN39109.)
- Excellent for hand or machine use.
- Contains no wax or silicone.
- Clear coat safe.
- VOC content less than 15%.



Part Number	Container Size	Containers Per Case
051131-39009	16 oz.	6
051131-39809	1 Gallon	4

3M™ Plastic Polish

- Removes hairline scratches or other minor imperfections from automotive plastics.
- Cleans and polishes.
- Restores optical clarity.
- VOC content less than 15%.



Part Number	Container Size	Containers Per Case
051131-39010	8 oz.	6

3M™ Perfect-It™ III Show Car Rubbing Compound (Extra Cut)

- Excellent rubbing compound for all paints.
- Fastest cutting rubbing compound designed to remove grade 1000 or finer sand scratches, medium oxidation, heavy swirl marks and fine scratches on even the hardest painted surfaces.
- Fast cut/excellent finish.
- Excellent for hand or machine use.
- Easy cleanup.
- Contains no wax or silicone.
- Clear coat safe.
- Replace with PN39018.
- Exceeds 17% VOC; consult local regulations.



Part Number	Container Size	Containers Per Case
051131-39011	16 oz.	6

3M Car Care Product Line

NOTE: VOC statements refer to products manufactured after January 1, 2005; consult local regulations.

3M™ Perfect-It™ III Show Car Machine Glaze

- Quickly removes compound swirl marks, very fine scratches and light oxidation from all automotive paints.
- Produces a high gloss, swirl free finish without filling.
- Durable high-gloss finish.
- Excellent for hand or machine use.
- Easy application and removal.
- Contains no wax or silicone.
- Clear coat safe.
- Replace with PN39019.
- Exceeds 15% VOC; consult local regulations.



Part Number	Container Size	Containers Per Case
051131-39012	16 oz.	6

3M™ Perfect-It™ III Show Car Finishing Glaze

- Designed to provide a durable high gloss finish to automotive paints.
- Can be applied by hand or D/A.
- Removes easily.
- Easy application and removal.
- Contains no wax or silicone.
- Clear coat safe.
- Replace with PN39020.
- Exceeds 15% VOC; consult local regulations.



Part Number	Container Size	Containers Per Case
051131-39013	16 oz.	6

3M™ Plastic Cleaner

- Removes fine scratches, stains, or haziness from automotive plastics.
- Follow-up with an application of 3M™ Plastic Polish (PN39010).
- Removes fine scratches.
- VOC content less than 17%.



Part Number	Container Size	Containers Per Case
051131-39017	8 oz.	6

3M™ Perfect-It™ Show Car Liquid Wax

- Shines and protects new and like new paint finishes, producing a deep rich high gloss, lustrous, durable, "wet look" finish.
- **Ultra high gloss finish.**
- Excellent for hand or machine use.
- Retards UV light damage.
- Clear coat safe.
- VOC content less than 15%.



Part Number	Container Size	Containers Per Case
051131-39026	16 oz.	6
051131-39826	1 Gallon	4

Paint Finishing and Vehicle Appearance

3M Car Care Product Line

NOTE: VOC statements refer to products manufactured after January 1, 2005; consult local regulations.

3M™ Perfect-It™ Gloss Enhancer

- A quick and easy “spray on/wipe off” product that can recapture that just waxed look and feel.
- Use on dry or wet surfaces.
- **Show car finish touch up.**
- Cleans and shines.
- Clear coat safe.
- VOC content less than 15%.



Part Number	Container Size	Containers Per Case
051131-39034	16 oz.	6
051131-39834	1 Gallon	4

3M™ Tire & Wheel Cleaner

- Quickly and beautifully cleans wheels and tires in one easy step.
- Leaves tires and wheels brilliantly clean.
- Removes brake dust, grease and grime.
- Clear coat safe.



Part Number	Container Size	Containers Per Case
051131-39036	16 oz.	6

3M™ Leather & Vinyl Cleaner

- Cleans and conditions vinyl, leather, rubber and plastic surfaces.
- Deep cleans dirt and grime.
- Enhances appearance.
- Restores natural sheen.
- Fresh lemon scent.



Part Number	Container Size	Containers Per Case
051131-39040	16 oz.	6

3M™ Rubber Treatment & Tire Dressing

- Restores that deep black “new” look to tires and restores a deep rich natural appearance to exterior rubber bumpers or vinyl moldings.
- Easy to use.
- Cleans and rejuvenates.



Part Number	Container Size	Containers Per Case
051131-39042	16 oz.	6

3M™ One Step Cleaner Wax — Medium Oxidation Remover

- Rapidly cleans and removes most fine and medium scratches, surface imperfections, oxidation, and stubborn stains.
- Leaves a deep rich waxed finish.
- Excellent for hand or machine use.
- Clear coat safe.
- VOC content less than 15%.



Part Number	Container Size	Containers Per Case
051131-39066	16 oz.	6

3M™ Perfect-It™ Foam Polishing Pad Glaze Swirl Mark Remover

- Quickly removes very fine scratches, swirl marks, light oxidation, or minor stains while producing a deep rich swirl-free finish.
- **For light colored cars.** (For dark colored cars use PN39809.)
- Excellent for hand or machine use.
- Contains no wax or silicone.
- Clear coat safe.
- VOC content less than 15%.



Part Number	Container Size	Containers Per Case
051131-39109	16 oz.	6
051131-39819	1 Gallon	4

3M™ Perfect-It™ Show Car Paste Wax

- Shines and protects new and like new paint finishes, producing a deep rich high gloss, lustrous, durable, “wet look” finish.
- Contains 3M™ A.S.P. (Acrylic Silicone Polymer) formulation.
- Provides exceptionally durable, **ultra high gloss finish.**
- Excellent for hand or machine use.
- Retards UV light damage.
- Clear coat safe.
- VOC content less than 45%.



Part Number	Container Size	Containers Per Case
051131-39526	10.5 oz. Net Wt.	6

3M Car Care Product Line

NOTE: VOC statements refer to products manufactured after January 1, 2005; consult local regulations.

3M™ Chrome & Metal Polish

- Removes surface rust, oxidation, corrosion, and tarnish from chrome, stainless steel and other automotive metals such as brass, bronze or copper.
- Restores luster to automotive metals.



Part Number	Container Size	Containers Per Case
051131-39527	10 oz.	6

3M™ Mag & Aluminum Polish

- Removes oxidation, water spots, stains, brake dust, and other residue from non-coated magnesium and aluminum wheels.
- Restores lustrous finish.
- Cleans and shines.



Part Number	Container Size	Containers Per Case
051131-39529	10 oz.	6

3M™ Car Care Counter Display

- Wash, wax, renew assortment.
- Holds three bottles each of 3M™ Car Wash Shampoo (PN39000), 3M™ Liquid Wax (PN39026) and 3M Glass Enhancer (PN39034).



Part Number	Displays Per Case
051131-39922	1

3M™ Car Care Products Display

- Free-standing metal gondola.
- Specifically designed to display 1 case (6 each) of all the 3M™ Car Care Products.
- Includes header card and shelf labeling strips.
- Requires a minimal amount of construction.
- Dimensions: 59" H x 25.5" W x 15" D.
- NOTE: PRODUCTS FOR THE DISPLAY MUST BE ORDERED SEPARATELY.

Part Number	Quantity Per Case
051131-39924	1

PERFECT-IT™ 30000



THE NEXT GENERATION IN PAINT FINISHING



**3M™ PERFECT-IT™
3000**



EXTRA CUT RUBBING COMPOUND

3M™ Perfect-It™ 3000 Extra Cut Rubbing Compound is designed to remove P1200 and finer sand scratches with a wool pad, or P1500 and finer sand scratches with a foam pad. Works on fresh or cured automotive paint surfaces leaving a fine swirl mark finish.

- Recommended for hard paints
- Effectively removes grade P1200 and finer sand scratches
- To reduce compound time, use P3000 3M™ Trizact™ abrasive discs
- Non-Gritty formula produces a fine compound swirl mark

**3M™ PERFECT-IT™
3000**



RUBBING COMPOUND

3M™ Perfect-It™ 3000 Rubbing Compound is designed for use on fresh or cured automotive paint surfaces to remove grade 1500 and finer sand scratches with a foam pad, and produce a very fine compound swirl mark finish.

- Effectively removes grade 1500 and finer sand scratches
- Produces a very fine compound swirl mark finish
- Good handling – easy cleanup

**3M™ PERFECT-IT™
3000**



SWIRL MARK REMOVER

3M™ Perfect-It™ 3000 Swirl Mark Remover is designed to quickly and effectively remove compound swirl marks from all types of automotive paints, and produce an outstanding high gloss finish.

- Quickly and effectively removes compound swirl marks
- Produces an outstanding finish – great for black cars
- Good handling – easy cleanup

**3M™ PERFECT-IT™
3000**



FINAL GLAZE

3M™ Perfect-It™ 3000 Final Glaze is body shop safe and designed to produce a durable, high gloss finish on fresh or cured automotive paints.

- Hand or D/A applied
- Durable high gloss finish
- Body shop safe
- Excellent removal characteristics when used with a 3M™ Perfect-It™ Detailing Cloth

**3M™ PERFECT-IT™
3000**



SPOT FINISHING MATERIAL

3M™ Perfect-It™ 3000 Trizact™ Spot Finishing Material is designed to remove grade P3000 3M™ Trizact™ Hookit™ II Abrasive Disc sand scratches, or to remove compound swirl marks and leave an excellent high gloss finish.

- Effectively removes 3M™ Trizact™ Hookit™ II Foam Disc grade P3000 sand scratches
- Ideal for spot repairs
- Quickly and effectively removes compound swirl marks
- Good handling – easy cleanup – high gloss finish

UPGRADE TO THESE GREAT NEW PRODUCTS

FROM THIS

TO THIS



PN 05940 / 05936
Gallon / Quart
**3M™ PERFECT-IT™ III
EXTRA CUT
RUBBING COMPOUND**

PN 06061 / 06060
Gallon / Quart
**3M™ PERFECT-IT™
3000 EXTRA CUT
RUBBING COMPOUND**



PN 05934 / 05933
Gallon / Quart
**3M™ PERFECT-IT™ III
RUBBING COMPOUND**

PN 06063 / 06062
Gallon / Quart
**3M™ PERFECT-IT™
3000 RUBBING COMPOUND**



PN 05938 / 05937
Gallon / Quart
**3M™ PERFECT-IT™ III
MACHINE GLAZE**

PN 06065 / 06064
Gallon / Quart
**3M™ PERFECT-IT™ 3000
SWIRL MARK REMOVER**



PN 05943 / 05941
Gallon / Quart
**3M™ PERFECT-IT™ III
FINISHING GLAZE**

PN 06067 / 06066
Gallon / Quart
**3M™ PERFECT-IT™
3000 FINAL GLAZE**



PN 05931 / 05930
Gallon / Quart
**3M™ PERFECT-IT™ III
TRIZACT™ MACHINE GLAZE**

PN 06071 / 06070
Gallon / Quart
**3M™ PERFECT-IT™
3000 TRIZACT™ SPOT
FINISHING MATERIAL**

ORDERING INFORMATION

Abrasives

D/A SANDING

Part No.	Description	Size	Grade	Discs/ Box	Boxes/ Case
00850	3M™ Hookit™ II Finishing Film Discs	6 in.	P1500	50	4
00868	3M™ Hookit™ II Finishing Film Discs	6 in.	P1200	50	4
00869	3M™ Hookit™ II Finishing Film Discs	6 in.	P1000	50	4
00750	3M™ Hookit™ II Finishing Film Discs – Dust Free	6 in.	P1500	50	4
00768	3M™ Hookit™ II Finishing Film Discs – Dust Free	6 in.	P1200	50	4
00769	3M™ Hookit™ II Finishing Film Discs – Dust Free	6 in.	P1000	50	4
02075	3M™ Trizact™ Hookit™ II Foam Disc	6 in.	P3000	15	4

Accessories

Part No.	Description	Size	Pads/ Case
05274	3M™ Hookit™ II Soft Interface Pad	6 in.	10
05251	3M™ Hookit™ II Disc Pad	6 in.	10
05356	3M™ Hookit™ II Low Profile Backup Pad – Dust Free	6 in.	10

WET SANDING

Part No.	Description	Grade	Sheets/ Sleeve	Sleeves/ Case
02021	3M™ Imperial™ Wetordry™ Paper Sheets	Ultra Fine 1000	50	5
02022	3M™ Imperial™ Wetordry™ Paper Sheets	Micro Fine 1200	50	5
02023	3M™ Imperial™ Wetordry™ Paper Sheets	Micro Fine 1500	50	5
02044	3M™ Imperial™ Wetordry™ Paper Sheets	Micro Fine 2000	50	5
02045	3M™ Imperial™ Wetordry™ Paper Sheets	Micro Fine 2500	50	5

Finishing System Products

COMPOUNDING

Pads				
Part No.	Description	Type	Pads/ Bag	Bags/ Case
05700	3M™ Superbuff™ Buffing Pad	100% Wool	1	24
05701	3M™ Superbuff™ 2 Plus 2 Buffing Pad	Blended Wool	1	24
05703	3M™ Superbuff™ III Buffing Pad	100% Wool	1	6
05704	3M™ Superbuff™ III 2 Plus 2 Buffing Pad	Blended Wool	1	6
05711	3M™ Hookit™ Plus Compounding Pad – 9 in.	Blended Wool	1	24
05719	3M™ Perfect-It™ III Compounding Pad – 9 in.	100% Wool	1	24
05723	3M™ Perfect-It™ Foam Compounding Pad – 8 in.	Convuluted Foam	2	12
05731	3M™ Perfect-It™ Plus Rounded Edge Foam Compounding Pad – 8½ in.	Convuluted Foam	1	6
05734	3M™ Perfect-It™ III Rounded Edge Foam Compounding Pad – 8 in.	Convuluted Foam	1	6
05737	3M™ Perfect-It™ Plus Foam Compounding Pad – 8 in.	Convuluted Foam	1	6
85078	3M™ Finesse-It™ Knit Buffing Pad – 3 in.	—	—	10

Compounds

Part No.	Description	Items/Unit	Qty/Case
06060	3M™ Perfect-It™ 3000 Extra Cut Rubbing Compound	1 Quart	6
06061	3M™ Perfect-It™ 3000 Extra Cut Rubbing Compound	1 Gallon	4
06062	3M™ Perfect-It™ 3000 Rubbing Compound	1 Quart	6
06063	3M™ Perfect-It™ 3000 Rubbing Compound	1 Gallon	4

Accessories

Part No.	Description	Items/Unit	Qty/Case
05710	3M™ Superbuff™ Adapter	1	10
38070	3M™ Perfect-It™ III Cleaner Clay	1	6

MACHINE GLAZES

Pads				
Part No.	Description	Type	Pads/ Bag	Bags/ Case
05705	3M™ Superbuff™ Polishing Pad – 9 in.	Blended Wool	1	24
05713	3M™ Hookit™ Polishing Pad – 9 in.	Single Sided Blended Wool	1	24
05725	3M™ Perfect-It™ Foam Polishing Pad – 8 in.	Convuluted Foam	2	12
05726	3M™ Perfect-It™ Hookit™ Foam Polishing Pad – 3 in.	Convuluted Foam	10	40
05735	3M™ Perfect-It™ Plus Rounded Edge Foam Polishing Pad – 8½ in.	Convuluted Foam	1	6
05738	3M™ Perfect-It™ Plus Foam Polishing Pad – 8 in.	Convuluted Foam	1	6

MACHINE GLAZES (cont.)

Swirl Mark Remover			
Part No.	Description	Items/Unit	Qty/Case
06064	3M™ Perfect-It™ 3000 Swirl Mark Remover	1 Quart	6
06065	3M™ Perfect-It™ 3000 Swirl Mark Remover	1 Gallon	4
06070	3M™ Perfect-It™ 3000 Trizact™ Spot Finishing Material	1 Quart	6
06071	3M™ Perfect-It™ 3000 Trizact™ Spot Finishing Material	1 Gallon	4

Accessories

Part No.	Description	Items/Unit	Qty/Case
05718	3M™ Perfect-It™ Backup Pad (for use on 3M™ Superbuff™ Adapter PN 05710)	1 pad	1 each

GLAZING

Pads			
Part No.	Description	Pads/ Bag	Bags/ Case
05729	3M™ Perfect-It™ Foam Polishing D/A Pad – 6 in.	2	12
05739	3M™ Perfect-It™ Hookit™ II Foam D/A Glazing Pad	2	12

Glazes

Part No.	Description	Items/Unit	Qty/ Case
06066	3M™ Perfect-It™ 3000 Final Glaze	1 Quart	6
06067	3M™ Perfect-It™ 3000 Final Glaze	1 Gallon	4

Accessories

Part No.	Description	Size	Pads/ Case
05251	3M™ Hookit™ II Disc Pad	6 in.	10
05356	3M™ Hookit™ II Low Profile Backup Pad – Dust Free	6 in.	10

Wipes

Part No.	Description	Cloths/ Pack	Packs/ Case
39016	3M™ Perfect-It™ III Show Car Detailing Cloth	1	12
06016	3M™ Perfect-It™ III Detailing Cloth	6	6
06017	3M™ Perfect-It™ III Detailing Cloth	50	1
06018	3M™ Perfect-It™ III Detailing Cloth	6	6

ACCESSORIES

Part No.	Description	Qty/Case
37720	3M™ Detailing Squeeze Bottle (Perfect-It™ 3000 labels available upon request from 3M Sales Representative)	24

3M Rubbing Compounds

NOTE: VOC statements refer to products manufactured after January 1, 2005; consult local regulations.

3M™ Perfect-It™ III Rubbing Compound

- Excellent cut combined with a high-gloss, ultra-fine finish.
- Completely removes sand scratches without filling.
- Easy to detail from doorjambes, cracks and moldings.
- Little spatter and sling makes cleanup a snap.
- Exceeds 17% VOC; consult local regulations.



Part Number	Suggested Replacement	Container Size	Containers Per Case
051131-05933	PN06062	1 Quart	12
051131-05934	PN06063	1 Gallon	4

3M™ Perfect-It™ III Extra Cut Rubbing Compound

- Fast-cutting/excellent finish.
- Excellent compound for cured/problem paints.
- Easy cleanup.
- Exceeds 17% VOC; consult local regulations.



Part Number	Suggested Replacement	Container Size	Containers Per Case
051131-05936	PN06060	1 Quart	12
051131-05940	PN06061	1 Gallon	4

3M™ Super Duty Rubbing Compound

- Aggressive compound.
- Remains wet on the job with little or no mess.
- Maintains high rate of cut with constant pressure.
- Buffs to high gloss with minimum of swirl marks.
- Excellent for hand or machine use.
- VOC content less than 17%.



Part Number	Container Size	Containers Per Case
051131-05954	1 Quart	12
051144-05955	1 Gallon	4

3M™ Perfect-It™ II Rubbing Compound

- Specially designed medium-cutting compound for removing grade 1200, 1500 and 2000 color sanding scratches in automotive paints including clear coats.
- Unique formulation.
- Produces minimal compound swirl marks while buffing to a high gloss.
- When followed by the 3M™ Perfect-It™ Foam Polishing Pad Glaze, this two-step system delivers a showcar luster in record time.
- Use with 3M™ Perfect-It™ Foam Compounding Pad (PN05723).
- VOC content less than 17%.



Part Number	Container Size	Containers Per Case
051131-05973	1 Quart (Liquid)	12
051131-05974	1 Gallon (Liquid)	4
051131-05983	1 Gallon (Paste)	4

3M™ Imperial™ Microfinishing Compound

- Specially formulated medium cut compound.
- For removing grade microfine 1200, 1500 and 2000 sand scratches in automotive paints including clear coat finishes.
- Available in either liquid or paste form.
- Exceeds 17% VOC; consult local regulations.



Part Number	Suggested Replacement	Container Size	Containers Per Case
051131-06011	PN05973	1 Quart (Liquid)	12
051131-06021	PN05974	1 Gallon (Liquid)	4
051131-06031	PN05983	1 Gallon (Paste)	4

3M™ Imperial™ Ultrafinishing Rubbing Compound — Paste

- Aggressive cutting paste compound.
- Use on refinished acrylic lacquer, to remove ultra fine 1000 sand scratches.
- Exceeds 17% VOC; consult local regulations.



Part Number	Suggested Replacement	Size	Gallons Per Case
051131-06032	PN05983	1 Gallon	4

3M™ Perfect-It™ 3000 Extra Cut Rubbing Compound

- Excellent cutting compound combined with a fine finish.
- Removes grade P1200 and finer sand scratches without filling.
- Easy to detail from door jambes, cracks and moldings.
- Excellent handling characteristics.
- VOC content less than 17%.
- Replaces PN05936 (Quart) and PN05940 (Gallon) effective April 1, 2005.



Part Number	Container Size	Containers Per Case
051131-06060	1 Quart	6
051131-06061	1 Gallon	4

3M™ Perfect-It™ 3000 Rubbing Compound

- Fast cutting compound combined with an ultra-fine finish.
- Removes grade P1500 and finer sand scratches without filling.
- To reduce compounding time, use grade P3000 3M™ Trizact™ abrasive discs before compounding.
- Easy to detail from door jambes, cracks and moldings.
- Excellent handling characteristics.
- VOC content less than 17%.
- Replaces PN05933 (Quart) and PN05934 (Gallon) effective April 1, 2005.



Part Number	Container Size	Containers Per Case
051131-06062	1 Quart	6
051131-06063	1 Gallon	4

3M Surface Preparation

3M™ Tack Pad Dispenser

- Clean storage.
- Easy dispensing.
- Stores up to fourteen pads.
- Convenient wall mounting.



Dispensers
Per Case

Part Number
051131-07909

1

3M™ Tack Pad

- A three-dimensional pad that absorbs dust particles.
- Has good conformability, excellent dust collection and leaves no adhesive transfer.
- Specifically designed for the final step in surface preparation before spraying primers, base coat or clear coat paints.



Part Number	Pads Per Box	Boxes Per Case
051131-07910	10	6

3M Compounding Pads

3M™ Superbuff™ Buffing Pad — 9"

- Unique double face construction.
- Allows both sides of the pad to be used.
- Built-in lightweight support pad eliminates the need for heavy backup pads.
- Soft usable edge means those hard-to-get-at areas are no longer a problem.
- Edge burn is virtually eliminated.
- Use with 3M™ Superbuff™ Adapter (PN05710).
- Fits all standard (5/8" shaft) slow-speed polishers.



Part Number	Pads Per Case
051144-05700	24

3M™ Superbuff™ 2 Plus 2 Pad — 9"

- "2 plus 2" features 2 sides to buff with, plus 2 major advantages:
 - More flexible — Gets into tight areas and reverse curves more easily.
 - Longer life — Provides greater economics to your buffing operation.
- Heavy backup pads are eliminated.
- Lightweight support system built in the pads.
- Use with 3M™ Superbuff™ Adapter (PN05710).
- Fits all standard (5/8" shaft) slow-speed polishers.



Part Number	Pads Per Case
051144-05701	24

3M™ Superbuff™ III Buffing Pad

- 100% untwisted wool.
- Aggressive, fast-cutting pad.
- Stiffer center hub for more cutting power.
- Double-sided pad.
- Excellent for hard paints.
- Use with 3M™ Superbuff™ Adapter (PN05710).
- Fits all standard (5/8" shaft) slow-speed polishers.



Part Number	Pads Per Case
051131-05703	6

3M™ Superbuff™ III 2 Plus 2 Buffing Pad

- Blended untwisted wool.
- Stiffer center hub for more cutting power.
- Double-sided pad.
- Less aggressive than 100% wool.
- Use with 3M™ Superbuff™ Adapter (PN05710).
- Fits all standard (5/8" shaft) slow-speed polishers.



Part Number	Pads Per Case
051131-05704	6

3M™ Hookit™ SBS™ Plus Compounding Pad — 9"

- New and improved compounding pad.
- New untwisted wool blend.
- Provides faster rate of cut, better finish and longer pad service life.
- Provides quick change advantages while producing exceptional finishes on today's paint systems.
- Designed to provide easy attachment and removal.
- Accurate centering to either the 3M™ Hookit™ SBS™ Backup Pad (PN05717) or 3M™ Perfect-It™ Backup Pad (PN05718).
- Fits all standard (5/8" shaft) slow-speed polishers.



Part Number	Description	Pads Per Case
051131-05711	Compounding Pad	24

3M™ Perfect-It™ III Compounding Pad — 9"

- Single-sided.
- 100% wool pad.
- Untwisted yarn.
- Excellent for hard paints.
- Aggressive fine cutting pad.



Part Number	Description	Pads Per Case
051131-05719	Compounding Pad	24

3M Compounding Pads

3M™ Perfect-It™ Hookit™ II Foam Compounding Pad — 3"

- 3M™ Hookit™ II attachment system.
- Designed for use with compounds or medium cutting glazes.
- Use with 3" 3M™ Perfect-It™ Hookit™ Foam Polishing Pad (PN05726) for finer finishing.
- Available early 2005.

Part Number	Pads Per Bag	Bags Per Case
051131-05721	2	6

3M™ Perfect-It™ Foam Compounding Pad — 8"

- Utilizes a 3M patented convoluted foam face.
- When used with 3M™ Perfect-It™ II Rubbing Compound (PNs 05973 or 05974), micro fine 2000 grade scratches are effectively removed from any automotive paint finish leaving an extremely fine finish.
- Easily attaches to 3M™ Backup Pads (PNs 05717 or 05718).
- Fits all standard (5/8" shaft) slow-speed polishers.



Part Number	Description	Pads Per Bag	Bags Per Case
051131-05723	Foam Compounding Pad	2	12

3M™ Perfect-It™ Plus Rounded Edge Foam Compounding Pad — 8-3/4"

- Utilizes a 3M patented convoluted foam face.
- New rounded edges for added protection.
- Attaches to either 3M™ Hookit™ SBS™ Backup Pad (PN05717) or 3M™ Perfect-It™ Backup Pad (PN05718).
- Fits all standard (5/8" shaft) slow-speed polishers.



Part Number	Description	Pads Per Case
051131-05731	Foam Compounding Pad	6

3M™ Perfect-It™ III Rounded Edge Foam Compounding Pad — 8"

- Utilizes a 3M patented convoluted foam face.
- Aggressive, fast-cutting pad.
- User friendly lint-free system.
- 3M patented design.



Part Number	Description	Pads Per Case
051131-05734	Foam Compounding Pad	6

3M™ Perfect-It™ Plus Foam Compounding Pad — 8"

- Utilizes a 3M patented convoluted foam face.
- New reduced diameter loop attachment backing for added edge protection.
- Attaches to either 3M™ Hookit™ Backup Pad (PN05717) or 3M™ Perfect-It™ Backup Pad (PN05718).
- Fits all standard (5/8" shaft) slow-speed polishers.



Part Number	Description	Pads Per Case
051131-05737	Foam Compounding Pad	6

3M™ Finesse-It™ Knit Buffing Pad — 3"

- Hook-and-Loop attachment.
- For compounding and polishing in hard-to-access areas.
- Use with 3M™ Hookit™ Disc Pad (PNs 05769 or 05770) and 3M™ Perfect-It™ II Rubbing Compound (PN05967) or 3M™ Finesse-It™ II Finishing Material (PN05928).
- For applying wax by machine in hard-to-access areas use with 3M™ Premium Paste Wax (PN06055).
- For machine glazing use with 3M™ Imperial™ Microfinishing Glaze (PN05992).
- For machine use in small areas use with 3M™ Chrome & Metal Polish (PN39527) or 3M™ Mag & Aluminum Polish (PN39529).



Part Number	Pads Per Case
051144-85078	10

3M Compounding Pads Accessories

3M™ Superbuff™ Adapter

- Adapter for the 3M™ Superbuff™ Buffering Pads (PNs 05700, 05701, 05703, 05704 and 05705).
- Works with 3M™ Perfect-It™ Backup Pad (PN05718).



Part Number	Adapters Per Case
051144-05710	10

3M™ Hookit™ SBS™ Backup Pad

- Designed to be used with 3M™ Compounding Pads (PNs 05711, 05719, and all foam pads).
- Designed to be used with 3M™ Polishing Pads (PNs 05713 and all foam pads).



Part Number	Pads Per Case
051131-05717	1

3M™ Perfect-It™ Backup Pad

- Specially designed backup pad for use with the 3M™ Superbuff™ Adapter (PN05710).
- Enables 3M™ Superbuff™ Compound Pad users to use the 3M™ Perfect-It™ Foam Polishing Pad without having to remove the 3M™ Superbuff™ Adapter from the shaft of the polisher.
- Fits all standard (5/8" shaft) slow-speed polishers.



Part Number	Pads Per Case
051131-05718	1

3M Machine Applied Glazes

NOTE: VOC statements refer to products manufactured after January 1, 2005; consult local regulations.

3M™ Finesse-It™ II Finishing Material

- Designed for use on O.E.M. and fully cured automotive paints.
- Can remove Grade Microfine 1500 3M™ Imperial™ Wetordry™ sand scratches.
- Removes swirl marks after compounding, while leaving a glazed finish.
- VOC content less than 17%.



Part Number	Container Size	Containers Per Case
051131-05928	1 Quart	12
051131-05929	1 Gallon	4

3M™ Perfect-It™ III Machine Glaze

- Quickly removes compound swirl marks.
- Produces a high-gloss, swirl-free finish quickly.
- Easy cleanup.
- Optimized for today's automotive paints.
- Exceeds 15% VOC; consult local regulations.



Part Number	Suggested Replacement	Container Size	Containers Per Case
051131-05937	PN06064	1 Quart	12
051131-05938	PN06065	1 Gallon	4

3M™ Perfect-It™ III Trizact™ Machine Glaze

- Use with 3M™ Trizact™ Hookit™ II Foam Discs (PNs 02075 or 02077).
- Removes 3M™ Trizact™ Hookit™ II Foam Disc sand scratches (grade P3000).
- Ideal for spot/small area repairs.
- Easy handling and excellent finish.
- Exceeds 15% VOC; consult local regulations.



Part Number	Suggested Replacement	Container Size	Containers Per Case
051131-05930	PN06070	1 Quart	12
051131-05931	PN06071	1 Gallon	4

3M™ Perfect-It™ III Finishing Glaze

- Hand or D/A applied.
- Apply by D/A to save time and effort.
- Silicone free.
- Produces a high-gloss, deep-luster durable finish.
- Exceeds 15% VOC; consult local regulations.



Part Number	Suggested Replacement	Container Size	Containers Per Case
051131-05941	PN06066	1 Quart	12
051131-05943	PN06067	1 Gallon	4

3M Machine Applied Glazes

NOTE: VOC statements refer to products manufactured after January 1, 2005; consult local regulations.

3M™ Imperial™ Machine Glaze

- Non-silicone, non-wax machine glaze.
- Possesses excellent scratch removal characteristics.
- Excellent depth of shine and luster.
- Use by machine to remove swirl marks after compounding acrylic lacquer.
- Formulated to work on all vehicle colors.
- Exceeds 15% VOC; consult local regulations.



Part Number	Suggested Replacement	Container Size	Containers Per Case
051131-05991	PN05995/05996	1 Quart	12
051131-06001	PN39809/39819	1 Gallon	4

3M™ Imperial™ Microfinishing Glaze

- Machine applied glaze.
- For use on automotive refinish acrylic enamel and urethane paints, air dried from 24 to 48 hours.
- Removes swirl marks left from compounding with 3M™ Imperial™ Microfinishing compounds.
- Use on base coat/clear coat paint systems.
- Exceeds 15% VOC; consult local regulations.



Part Number	Suggested Replacement	Container Size	Containers Per Case
051131-05992	PN05995/05996	1 Quart	12

3M™ Perfect-It™ Foam Polishing Pad Glaze

- Uniquely formulated to remove compound swirl marks.
- Leaves a mark-free finish when applied with the 3M™ Perfect-It™ Foam Polishing Pad.
- Compatible with all types of paint; glazes contain no wax or silicones.
- Both glazes are clear coat safe.
- Identical performance characteristics.
- 3M™ PN05996 provides easier detailing and cleanup on dark colored paints.
- VOC content less than 15%.



Part Number	Size	For Use On Paint Color	Containers Per Case
051131-05995	1 Quart	Light	12
051131-05996	1 Quart	Dark	12

3M™ Perfect-It™ 3000 Swirl Mark Remover

- Quickly and effectively removes compounding swirl marks.
- Produces a high-gloss and swirl-free finish.
- Excellent for dark colored cars, especially black!
- Easy clean up.
- VOC content less than 17%.
- Replaces PN05937 (Quart) and 05938 (Gallon) effective April 1, 2005.



Part Number	Container Size	Containers Per Case
051131-06064	1 Quart	6
051131-06065	1 Gallon	4

3M™ Perfect-It™ 3000 Trizact™ Spot Finishing Material

- Excellent for Paint Finishing spot repairs.
- Designed to effectively remove grade P3000 Trizact™ abrasive sand scratches for spot repairs.
- Removes compounding swirl marks.
- Easy handling and clean-up characteristics.
- VOC content less than 17%.
- Replaces PN05930 (Quart) and PN05931 (Gallon) effective April 1, 2005.



Part Number	Container Size	Containers Per Case
051131-06070	1 Quart	6
051131-06071	1 Gallon	4

3M Foam Discs

3M™ Trizact™ Hookit™ II Foam Discs

- A foam disc used for removing P3000 grade sand scratches prior to using 3M™ Perfect-It™ III Trizact™ Machine Glaze (PN05930 and 05931).
- This system is designed as a "spot repair" system for minimal amounts of paint imperfections on panels.



Part Number	Size	Discs Per Box	Boxes Per Case
051131-02077	3"	15	4
051131-02075	6"	15	4

3M Polishing Pads

3M™ Hookit™ Conversion Face Pad

- Must use with 3M™ Hookit™ Disc Pads (PNs 05769 and 02700) to use Hookit™ II discs.

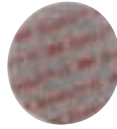

Part Number	Size	Quantity Per Case
051131-02322	3"	10

3M™ Hookit™ Disc Pad

- Must be converted to Hookit™ II by use of 3M™ Hookit™ Conversion Face Pad 3" (PN02322).
- Use with Trizact™ Hookit™ II Foam Disc 3" (PN02077).
- Fits most dual-action sanders (male stud).
- Use with 3M™ Hookit™ Soft Interface Pad 3" (PN05771) and with 3M™ Perfect-It™ Hookit™ Foam Polish Pads 3" (PN05726).



Part Number	Size	Quantity Per Case
02700*	3"	10

* UPC Bar Code 051111-55764

3M™ Superbuff™ Polishing Pad – 9"

- A double-sided, soft edge polishing pad.
- Specially designed for use with a polisher and glaze.
- Made of extremely fine fibers.
- Produces a high-gloss finish on paint surfaces.
- Features long life, flexibility, lightweight and balance.
- Fits all standard (5/8" shaft) slow-speed polishers.
- Use with 3M™ Superbuff™ Adapter (PN05710).



Part Number	Pads Per Case
051144-05705	24

3M™ Hookit™ Polishing Pad – 9"

- New and improved polishing pad.
- New untwisted wool blend.
- Provides faster rate of cut, better finish and longer pad service life.
- Provides quick change advantages while producing exceptional finishes on today's paint systems.
- Designed to provide easy attachment and removal.
- Accurate centering to the 3M™ Hookit™ Backup Pad (PNs 05717 or 05718).
- Fits all standard (5/8" shaft) slow-speed polishers.



Part Number	Pads Per Case
051131-05713	24

3M™ Perfect-It™ Hookit™ II Foam Polishing Pad – 3"

- 3M™ Hookit™ II attachment system.
- Designed for use with fine compounds or machine glazes.
- Use 3M™ Perfect-It™ Hookit™ II Foam Compounding Pad (PN05921) for more aggressive cut.
- Available early 2005.

Part Number	Pads Per Bag	Bags Per Case
051131-05722	2	6

3M™ Perfect-It™ Foam Polishing Pad – 8"

- Utilizes a 3M patented convoluted foam face.
- Produces a mark-free automotive paint surface when used in conjunction with 3M™ Perfect-It™ Foam Polishing Pad Glazes.
- Attaches to either 3M™ Hookit™ Backup Pad (PN05717) or 3M™ Perfect-It™ Backup Pad (PN05718).
- Fits all standard (5/8" shaft) slow-speed polishers.



Part Number	Pads Per Bag	Bags Per Case
051131-05725	2	12

3M™ Perfect-It™ Hookit™ Foam Polishing Pad – 3"

- Convoluted foam face for cool and swirl-free polishing.
- Easy-on/easy-off 3M™ Hookit™ attachment. Ideal size for getting into hard to reach areas.
- Designed to be used with 3M™ Hookit™ 3" Disc Pad (PNs 05769, 05770) and the 3M™ Finesse-It™ Roloc™ Finishing Pad (PN05924).
- Fits all standard (5/8" shaft) slow-speed polishers.



Part Number	Pads Per Bag	Bags Per Case
051131-05726	10	40

3M™ Perfect-It™ Foam Polishing D/A Pad

- Evenly applies finishing glaze.
- Faster glaze application.
- Utilizes a 3M patented gentle convoluted foam face.
- Use with 6" dual action sander.
- Use with 3M™ Hookit™ Disc Pad 6".



Part Number	Pads Per Bag	Bags Per Case
051131-05729	2	12

3M™ Perfect-It™ Plus Rounded Edge Foam Polishing Pad – 8-3/4"

- Utilizes a 3M patented convoluted foam face.
- New rounded edges for added protection.
- Attaches to either 3M™ Hookit™ Backup Pad (PN05717) or 3M™ Perfect-It™ Backup Pad (PN05718).
- Fits all standard (5/8" shaft) slow-speed polishers.



Part Number	Pads Per Case
051131-05735	6

3M Polishing Pads

3M™ Perfect-It™ Plus Foam Polishing Pad – 8"

- Utilizes a 3M patented convoluted foam face.
- New reduced diameter loop attachment backing for added edge protection.
- Attaches to either 3M™ Hookit™ Backup Pad (PN05717) or 3M™ Perfect-It™ Backup Pad (PN05718).
- Fits all standard (5/8" shaft) slow-speed polishers.



Part Number	Pads Per Case
051131-05738	6

3M™ Perfect-It™ Hookit™ II Foam D/A Glazing Pad

- 3M™ Hookit™ II compatible.
- Evenly applies finishing glaze.
- Faster glaze applications.
- Gentle convoluted foam.
- Use with 6" dual-action sander.
- Use with 6" 3M™ Hookit™ II Painter's Pad (PN05286).



Part Number	Pads Per Bag	Bags Per Case
051131-05739	2	12

3M™ Finesse-It™ Roloc™ Finishing Pad

- For use with standard 3M™ Roloc™ Disc Pads and slow-speed air or electric drills for fine grade sanding (3000 RPM).
- Face designed for 3" 3M™ Finesse-It™ Buffing Pad (PN05925).
- Also can be used with 3" diameter 3M™ Hookit™ Discs.



Part Number	Diameter Size	Pads Per Bag	Bags Per Case
051131-05924	3"	12	5

3M™ Finesse-It™ Buffing Pad

- Excellent for buffing and polishing in hard-to-reach areas.
- Use with 3M™ Perfect-It™ Wax (PNs 39026 and 39526), Glaze (PNs 39009 and 39109), and Compound (PNs 39002 and 39502).
- Use with slow-speed (3000 RPM) tools.



Part Number	Diameter Size	Pads Per Bag	Bags Per Case
051131-05925	3"	20	5

3M™ Finesse-It™ Hand Sanding Pad

- Solid rubber hand sanding pad holds 3M™ Finesse-It™ sanding discs firmly in place.
- Provides touch-up without finer marks.
- Designed for removing dust and dirt nibs.
- Fits the hand; provides excellent control for light sanding.



Part Number	Diameter Size	Pads Per Bag	Bags Per Case
051144-13441	1-1/4"	20	1

3M™ Finesse-It™ Knit Buffing Pad – 3"

- Hook-and-Loop attachment.
- For compounding and polishing in hard to access areas.
- Use with 3M™ Hookit™ Disc Pad (PNs 05769 or 05770) and 3M™ Perfect-It™ II Rubbing Compound (PN05967) or 3M™ Finesse-It™ II Finishing Material (PN05928).
- For applying wax by machine in hard to access areas use with 3M™ Premium Paste Wax (PN06055).
- For machine glazing use with 3M™ Imperial™ Microfinishing Glaze (PN05992).
- For machine use in small areas use with 3M™ Chrome & Metal Polish (PN39527) or 3M™ Mag & Aluminum Polish (PN39529).



Part Number	Pads Per Case
051144-85078	10

3M Polishing Pad Accessories

3M™ Hookit™ SBS™ Backup Pad

- Designed to be used with 3M™ Compounding Pads (PNs 05711 and 05723).
- Designed to be used with 3M™ Polishing Pads (PNs 05713 and 05725).
- Fits all standard (5/8" shaft) slow-speed polishers.



Part Number	Pads Per Case
051131-05717	1

3M™ Perfect-It™ Backup Pad

- Specially designed backup pad for use with the 3M™ Superbuff™ Adapter (PN05710).
- Enables 3M™ Superbuff™ Compound Pad users to use the 3M™ Perfect-It™ Foam Polishing Pad without having to remove the 3M™ Superbuff™ Adapter from the shaft of the polisher.
- Fits all standard (5/8" shaft) slow-speed polishers.



Part Number	Pads Per Case
051131-05718	1

3M Hand Applied Glazes/Polishes

NOTE: VOC statements refer to products manufactured after January 1, 2005; consult local regulations.

3M™ Detail Wax

- Produces a deep, rich, high-gloss, lustrous and durable “wet look” finish.
- Clear coat safe.
- Contains Carnuba Wax.
- Good replacement for 3M™ Liquid Polish (PN05993) and 3M™ Prep Team™ Liquid Polish (PN05939).
- VOC content less than 15%.



Part Number	Container Size	Containers Per Case
38111*	1 Gallon	4

*UPC Bar Code 051131-38211

3M™ Imperial™ Hand Glaze

- Non-silicone, non-wax hand glaze.
- Excellent depth of shine.
- Outstanding luster.
- Use by hand to refine and fill swirls after machine glazing refinish or factory applied paints.
- Specially formulated to work on all colors and can be painted over.
- VOC content less than 15%.



Part Number	Container Size	Containers Per Case
051131- 05990	1 Quart	12
051131- 06000	1 Gallon	4

3M™ Detail Polish 108

- Light cutting, very-fine finishing polish.
- High gloss finish on all automotive finishes.
- Produces a deep, rich, high-gloss and durable “wet look” finish.
- Contains Carnuba Wax.
- Excellent replacement for 3M™ Liquid Polish (PN05993), 3M™ Prep Team™ Liquid Polish (PN05939) and 3M™ Fill 'n Glaze Pink (PN05977).
- VOC content less than 15%.



Part Number	Container Size	Containers Per Case
38133*	1 Gallon	4

*UPC Bar Code 051131-39533

3M™ Perfect-It™ III Finishing Glaze

- Hand or D/A applied.
- Apply by D/A to save time and effort.
- Silicone free.
- Produces a high-gloss, deep-luster durable finish.
- Exceeds 15% VOC; consult local regulations.



Part Number	Suggested Replacement	Container Size	Containers Per Case
051131- 05941	PN06066	1 Quart	12
051131- 05943	PN06067	1 Gallon	4

3M™ Perfect-It™ 3000 Final Glaze

- Produces a high-gloss, deep luster and durable finish.
- Protects new finishes and is body shop safe.
- Hand or D/A applied.
- Easy on/easy off characteristics.
- VOC content less than 15%.
- Replaces PN05941 (Quart) and PN05943 (Gallon) effective April 1, 2005.



Part Number	Container Size	Containers Per Case
051131- 06066	1 Quart	6
051131- 06067	1 Gallon	4

3M Buffing Apron

3M™ Perfect-It™ 3000 Buffing Apron

- Sturdy construction.
- Comfortable to wear.
- Washable.
- Replacement for Buffing Apron PN05709.

Part Number	Each Per Case
051131- 06059	6

3M Waxes

NOTE: VOC statements refer to products manufactured after January 1, 2005; consult local regulations.

3M™ Premium Liquid Wax

- Clear coat safe wax.
- Use on all cured paint finishes.
- For use by hand or with an orbital polisher.
- Produces a high-gloss, deep-luster, durable finish on both new and used car paints.
- Special formulation is capable of removing road film or light oxidation from car finishes.
- Heavily oxidized finishes may require compounding with 3M™ Super Duty Rubbing Compound (PN39004) prior to applying wax.
- VOC content less than 15%.



Part Number	Container Size	Containers Per Case
051131-06005	1 Quart	12
051131-06006	1 Gallon	4

3M Wipes

3M™ Perfect-It™ Wax and Glaze Wipe

- Soft, non-linting wipe.
- Designed for easy application and removal of 3M hand-applied waxes and glazes.
- Special non-woven construction will not scratch sensitive dark automotive finishes which have been machine polished with the 3M™ Perfect-It™ Foam Polishing Pad System.

Part Number	Wipes Per Box	Boxes Per Case
051131-06010	120	6

3M™ Perfect-It™ Detailing Cloth

- Safe, chemical-free, streak-free and non-linting vehicle surface cleaning.
- Microfiber design quickly and easily removes oily and filmy residues.
- Use damp or dry on paint, chrome, glass or any other vehicle surface.
- Safe on clear coat paint.
- Washable, reusable and durable.



Part Number	Cloths Per Package	Packages Per Case
051131-06016	6	6

Part Number	Cloths Per Case
051131-06017	50

3M™ Perfect-It™ Jumbo Detailing Cloth

- New and improved detailing cloth! Jumbo 16" x 16" cloths.
- Safe, chemical-free, streak-free and non-linting vehicle surface cleaning.
- Microfiber design quickly and easily removes oily and filmy residues including waxes, polishes, glazes and fingerprints.
- Use damp or dry on paint, chrome, glass or any other vehicle surface.
- Safe on clear coat paint.
- Washable, reusable and durable.



Part Number	Cloths Per Package	Packages Per Case
051131-06018	6	6

3M™ Perfect-It™ Show Car Detailing Cloth

- New and improved detailing cloth!
- Chemical-free, streak-free and non-linting vehicle surface cleaning.
- Microfiber design quickly and easily removes oily and filmy residues including waxes, polishes, glazes and fingerprints.
- Use damp or dry on paint, chrome, glass or any other vehicle surface.
- Safe on clear coat paint.
- Washable, reusable and durable.



Part Number	Each Per Case
051131-39016	12

3M Cleaners/Conditioners

3M™ Prep Solvent-70

- A water-based solvent used to remove oil, wax, grease and silicone from surfaces prior to coating.
- Effectively cleans metal, primed metal and painted surfaces prior to the application of primer or paint.
- Rated at 70 grams per liter of volatile organic compounds (VOC).
- Currently meets regulations governing VOC emissions of surface preparation solvents.



Part Number	Container Size	Containers Per Case
051135-08983	1 Gallon	4

3M™ Perfect-It™ III Cleaner Clay

- Safely removes overspray and paint contaminants.
- Use with water-based lubricants.
- Effective on paint, glass and chrome.
- Packed in convenient storage tub.



Part Number	Each Per Case
051131-38070	6

3M Putties

3M™ Acryl-Green Spot Putty

- Fast-drying, easy-sanding putty.
- Designed for spot repairs.
- Spreads easily.



Part Number	Size/Net Wt.	Tubes Per Case
051144-05960	21 oz. Tube	12

3M™ Acryl-Red Glazing Putty

- Good general purpose putty.
- Fills small pinholes and scratches.
- Fills larger areas of imperfections.



Part Number	Size/Net Wt.	Tubes Per Case
051144-05966	21 oz. Tube	12

3M™ Acryl-Blue Glazing Putty

- Slow-drying, easy-spreading putty.
- Recommended for filling minor low areas and deeper sand scratches.
- Provides more working time.



Part Number	Size/Net Wt.	Tubes Per Case
051144-05964	21 oz. Tube	12

3M™ Super Red Putty

- Self-leveling, easy-to-spread putty.
- Excellent glazing putty.
- Designed to flow into and fill pinholes and scratches.
- A nitrocellulose putty.
- "Long working time" with minimal shrinkage.
- Feathers out to a smooth surface.
- Flows out to eliminate ridges and squeegee lines.
- Sands easily, even after overnight drying.
- Cuts down on extra sanding steps.



Part Number	Size/Net Wt.	Tubes Per Case
051144-05972	21 oz. Tube	12

3M Body Shop Clean-Up

3M™ Detailing Diluter — Single Product

- Mixes one product to proper dilution ratio.
- Cost-effective, controlled mixing.
- Adjust to mix 3M water-based products.
- For 3M™ Glass Cleaner, modify PN37712 with Kit #PD111, available from Shopware 1-800-877-9344; or use Glass Cleaner portion of 3M™ Detailing Diluter (PN37721).
- Includes tips to reset concentration ratios.



Part Number	Quantity Per Case
051131-37712	1

3M™ Detailing Spray Bottle

- 32-ounce fluorinated bottle.
- Use with 3M™ Spray Trigger Nozzle Head (PN37717) or 3M™ Solvent Spray Trigger Nozzle Head (PN37718).



Part Number	Quantity Per Case
051131-37716	1

3M Body Shop Clean-Up

3M™ Detailing General Purpose Spray Trigger Nozzle Head

- Use with water-based 3M Detailing Products.
- Long-lasting, adjustable sprayer.
- Red and white color.



Part Number	Quantity Per Case
051131-37717	1

3M™ Solvent Spray Trigger Nozzle Head

- Excellent for 3M solvent-based products.
- Long-lasting, adjustable sprayer.
- Blue and silver color.



Part Number	Quantity Per Case
051131-37718	24

3M™ Detailing Squeeze Bottle

- 12-ounce ketchup-style bottle.
- Includes spout top.
- Use for dispensing compounds, glazes, polishes and liquid wax.
- See 3M Sales Representative for product labels.



Part Number	Quantity Per Case
051131-37720	24

3M™ Detailing Diluter (CWS, APC&D, GC)

- Automatically mixes to proper dilution ratios for cost-effective, controlled mixing.
- Preset for three 3M detailing products:
 - 3M™ Glass Cleaner at 1 to 14
 - 3M™ Car Wash Soap at 1 to 100
 - 3M™ All Purpose Cleaner and Degreaser at 1 to 15
- Replaces previous 3M™ Detailing Diluter (PN37711).
- Includes tips to reset concentration ratios.



Part Number	Quantity Per Case
051131-37721	1

3M™ Silicone-Free Tire Dressing

- Contains no silicone; designed for paint shop environment.
- Conditions exterior rubber and vinyl surfaces.
- Produces a deep black, glossy appearance on newer tires.
- Produces a deep black, natural appearance on older tires.
- Apply via applicator pad or spray bottle (PN37718).
- **Important: Read and follow product use instructions.**
- Greater than 80% VOC; check local regulations.



Part Number	Container Size	Containers Per Case
051131-38327	1 Gallon	4
051131-38328	5 Gallon Pail	1

3M™ All Purpose Cleaner & Degreaser — Concentrate

- Cleaner/degreaser concentrate for exterior and interior cleaning.
- Use for vinyl, cloth or carpet cleaning.
- Contains no silicones; designed for paint shop environment.
- Dilution — 1 part product to 15 parts water (makes 16 gallons) for degreasing, doorjamb and pre-spotting carpets.
- Dilution — 1 part product to 30 parts water (makes 31 gallons) for general purpose interior cleaning.



Part Number	Container Size	Quantity Per Case
051131-38350	1 Gallon	4
051131-38351	5 Gallon Pail	1

3M™ Heavy Duty Wheel Cleaner — Concentrate

- Does not contain Hydrofluoric or other strong acids.
- Contains no silicones; designed for paint shop environment.
- Removes brake dust from wheels and rims.
- Use with 3M™ All Purpose Cleaner and Degreaser for removal of dirt, grease and oil from wheels and rims.
- Effective for removing water spots from exterior painted vehicle surfaces.
- Do not use on non-coated wheels, engines or glass.
- Dilution — 1 part product to 2 parts concentrate (makes 3 gallons).



Part Number	Container Size	Quantity Per Case
051131-38374	1 Gallon	4
051131-38375	5 Gallon Pail	1

3M™ Car Wash Soap — Concentrate

- Removes dirt and grime without removing wax protection.
- Lubricant for 3M™ Perfect-It™ III Cleaner Clay.
- Phosphate-free.
- Contains no silicones; designed for paint shop environment.
- Excellent for wet sanding lubricant.
- Dilution — 1 part product to 100 parts water (makes 101 gallons).



Part Number	Container Size	Quantity Per Case
051131-38377	1 Gallon	4
051131-38378	5 Gallon Pail	1

3M™ Glass Cleaner — Concentrate

- Non-streaking formula.
- Ammonia-free.
- Contains no silicones; designed for paint shop environment.
- Dilution — 1 part product to 14 parts water (makes 15 gallons).



Part Number	Container Size	Quantity Per Case
051131-38399	1 Gallon	4
051131-38300	5 Gallon Pail	1

3M Detailing Products

3M™ All Purpose Cleaner (APC) and Degreaser

- Use for engines, door jams and general degreasing.
- Dilution — 1 part product to 15 parts water (makes 16 gallons) for degreasing or higher for general purpose cleaning.
- Dilution — 1 part product to 30 parts water (makes 31 gallons) for general purpose interior cleaning.



Part Number	Container Size	Containers Per Case
38050*	1 Gallon	4
051131- 38051	5 Gallon Pail	1
38052**	55 Gallon Drum	1

* UPC Bar Code 051131-39150

** UPC Bar Code 051131-39152

3M™ Heavy Duty Wheel Cleaner — Concentrate

- Does not contain Hydrofluoric or other strong acids.
- Removes brake dust from wheels and rims.
- Do not use on non-coated wheels, glass or engine compartments!
- Not recommended for use on non-coated wheels.
- Effective for removing water spots from exterior vehicle surfaces.
- Dilution — 1 part product to 2 parts water (makes 3 gallons).



Part Number	Container Size	Containers Per Case
051131- 38074	1 Gallon	4
051131- 38075	5 Gallon Pail	1
051131- 38076	55 Gallon Drum	1

3M™ Car Wash Soap — Concentrate

- Safely removes dirt and grime without removing wax protection.
- Lubricant for 3M™ Perfect-It™ III Cleaner Clay (PN38070).
- Phosphate-free.
- Dilution — 1 part product to 100 parts water (makes 101 gallons).



Part Number	Container Size	Containers Per Case
051131- 38077	1 Gallon	4
051131- 38078	5 Gallon Pail	1
051131- 38079	55 Gallon Drum	1

3M™ Adhesive Remover

- Specially blended solvent.
- Quickly removes adhesive residue.
- Will not harm most thoroughly cured automotive paints, vinyls or plastics when properly used.
- 100% VOC; check local requirements.



Part Number	Container Size	Containers Per Case
051131- 38080	1 Gallon	4
051131- 38081	5 Gallon Pail	1
051131- 38082	55 Gallon Drum	1

3M™ Engine and Tire Dressing

- Uniformly coats and shines engine hoses, plastics and moldings.
- Does not harm vehicle or rubber parts.
- Dilution — 1 part product to 1 part water (makes 2 gallons).
- Tire and rubber dressing for low VOC requirements.



Part Number	Container Size	Containers Per Case
051131- 38124	1 Gallon	4
051131- 38125	5 Gallon Pail	1
051131- 38126	55 Gallon Drum	1

3M™ Tire Dressing

- Gives a deep black, lustrous appearance to vehicle tires, door and trunk moldings.
- Also effective on exterior trim moldings and bumpers.
- Exceeds 80% VOC; check local requirements (see PNs 38124, 38125 and 38126 for low VOC product).



Part Number	Container Size	Containers Per Case
051131- 38127	1 Gallon	4
051131- 38128	5 Gallon Pail	1
051131- 38129	55 Gallon Drum	1

3M Detailing Products

3M™ Silicone-Free Tire Dressing — Concentrate

- Contains no silicone, designed for paint shop environment.
- Conditions exterior rubber and vinyl surfaces.
- Produces a deep black, glossy appearance on newer tires.
- Produces a deep black, natural appearance on older tires.
- Apply via applicator pad or spray nozzle (PN37718).
- **Important: Read and follow product use instructions.**
- Greater than 80% VOC; check local regulations.



Part Number	Container Size	Containers Per Case
051131- 38327	1 Gallon	4
051131- 38328	5 Gallon Pail	4

3M™ Extraction Cleaner — Concentrate

- Cleans carpet and upholstery.
- Specifically designed for use in extraction equipment.
- Recommend pre-spotting stains with 3M™ All-Purpose Cleaner (APC) and Degreaser (PNs 38050, 38350, 38051, 38351 and 38052).
- Dilution — 1 part product to 250 parts water (makes 251 gallons).



Part Number	Container Size	Containers Per Case
051131- 38095	1 Gallon	4

3M™ Glass Cleaner — Concentrate

- Non-streaking formula.
- Ammonia-free.
- Dilution — 1 part product to 14 parts water.
- Use with 3M™ Detailing Diluter (PN37712) with kit (PD111) or glass portion on PN37721.
- VOC content less than 4% at 1:14 dilution ratio.



Part Number	Container Size	Containers Per Case
051131- 38099	1 Gallon	4
051131- 38100	5 Gallon Pail	1
051131- 38101	55 Gallon Drum	1

3M™ Premium Glass Cleaner — Concentrate

- Excellent for high humidity conditions.
- Non-streak formula.
- Ammonia-free.
- Dilution — 1 part product to 14 parts water.
- Use with 3M™ Detailing Diluter (PN37712) with kit (PD111) or glass portion on PN37721.
- VOC content less than 4% at 1:14 dilution ratio.



Part Number	Container Size	Containers Per Case
051131- 38221	1 Gallon	4
051131- 38222	5 Gallon Pail	1

3M™ Interior Dressing

- For use on interior vinyl, plastic and rubber surfaces.
- Produces a deep color, natural gloss appearance.
- VOC content less than 15%.



Part Number	Container Size	Containers Per Case
051131- 38086	1 Gallon	4
051131- 38087	5 Gallon Pail	1

3M™ Detail Wax

- Produces a deep, rich, high-gloss, lustrous and durable “wet look” finish.
- Clear coat safe.
- Contains Carnuba Wax.
- Good replacement for 3M™ Liquid Polish (PN05993) and 3M™ Prep Team™ Liquid Polish (PN05939).
- VOC content less than 15%.



Part Number	Container Size	Containers Per Case
38111*	1 Gallon	4

*UPC Bar Code 051131-38211

3M Detailing Products

3M™ Detail Polish #108

- Light cutting, very-fine finishing polish.
- High gloss finish on all automotive finishes.
- Produces a deep, rich, high-gloss and durable “wet look” finish.
- Contains Carnuba Wax.
- Excellent replacement for 3M™ Liquid Polish (PN05993), 3M™ Prep Team™ Liquid Polish (PN05939) and 3M™ Fill ‘n Glaze Pink (PN05977).
- VOC content less than 15%.



Part Number	Container Size	Containers Per Case
38133*	1 Gallon	4

*UPC Bar Code 051131-39533

3M™ Detail Compound #308

- Fast cutting.
- Removes medium to heavier oxidation and scratches.
- Works great on cured paint.
- VOC content less than 17%.



Part Number	Container Size	Containers Per Case
051131- 38105	1 Gallon	4

3M™ Gloss Enhancer

- Quick and easy “spray-on/wipe-off” product.
- Cleans and adds shine and depth to painted surfaces.
- Clear coat safe.
- VOC content less than 15%.



Part Number	Container Size	Containers Per Case
051131- 38113	1 Gallon	4
051131- 38114	5 Gallon Pail	1

3M™ Detail Polish #208

- Medium cutting finish polish.
- Removes light to medium oxidation and fine scratches.
- Leaves an excellent high-gloss finish on all types of automotive paints.
- Clear coat safe.
- VOC content less than 15%.



Part Number	Container Size	Containers Per Case
051131- 38116	1 Gallon	4

Miscellaneous Diluter and Accessory Parts

- Available from Shopware Inc.
Phone # 1-800-877-9344
Fax # 952-392-2018 for order form
- Other accessories parts/service available.
- Shopware part numbers below.
- Pay via Visa, MasterCard or American Express.

Part Number	Description
PD100	Diluter tip kit (5 kits with 14 sizes)
PD101	Viton® foot valve (blue color 5/kit)
PD102	In-line check valve (blue color 3/kit)
PD103	Pickup tube kit (1 tube, 3 weights, 3 Viton® foot valve)
PD104	Diluter (PN37711) selector switch
PD105	Glass cleaner foot valve (gray color 5/kit)
PD106	Rieke Spout Spigot (for 5 gallon round and one gallon plastic 2/kit)
PD107	Male NPT Spigot (for 5 gallon cubes 2/kit)
PD108	Utility funnel (16 oz. 3/kit)
PD109	Glass Cleaner in-line valve (gray color 3/kit)
PD110	5-Shelf Stack Rack (for 5-gallon cubes; black color) Price includes shipping and handling.
PD111	Conversion kit (PN37712) to Glass Cleaner

Viton® is a registered trademark of Dupont Dow Elastomers L.L.C. Corporation.

Scrubbers and Sponges

3M™ Scrubbers

- Ideally suited for camping and cleanup.
- Available in two colors:
 - Black, for "tough jobs" like cleaning cooking grills.
 - White, for "light jobs" like removing bugs from RV's, cleaning fiberglass plastic tubs and showers, sinks and counter tops plus RV window frames.



Part Number	Color	Scrubbers Per Case
7721	Black	12
7723	White	12

O-Cel-O™ StayFresh Home, Car and Boat Sponge

- Great for big jobs around the house and washing the car and boat.
- Excellent boat bailer.



Part Number	Size	Sponges Per Case
053200-07220	9" x 4-1/2" x 1-3/4"	12

3M™ Niagara™ Sponge Cloth

- Cleans like a sponge, wipes like a cloth, and outlasts paper towels.



Part Number	Size	Sponges Per Case
053200-07330	8" x 7-1/8" x 1/8"	24

3M™ Commercial Sponge

- Commercial-sized for big jobs when you need a long-lasting, industrial product.

Part Number	Size	Sponges Per Case
053200-07449	6" x 4-1/4" x 1-5/8"	12

Retail Appearance Products

3M™ All-Purpose Tack Cloth

- Excellent for cleanup just before painting.
- Use to remove dirt, lint, dust and sanding particles from metal, plastic, fiberglass and wood surfaces without smearing.
- Use again and again.
- Stays soft.
- Non-toxic.



Part Number	Size	Cloths Per Pack	Packs Per Case
051144-03192	16" x 20"	1	40

3M™ Polishing Pads

- Two-sided polishing pad with the backup pad built right in.
- Backup pad prevents slippage, means less weight.
- Gives twice the polishing surface.
- Handy 6" diameter can be used on 1/4" or 3/8" drill.



Part Number	Pads Per Case
051144-05720	12

3M™ Upholstery and Carpet Cleaner

- Unique formula gently loosens tough stains and dirt.
- Effectively cleans high-traffic and heavily soiled areas.
- Restores and brightens carpet and upholstery.



Part Number	Size	Cans Per Case
051131-03574	19 oz. Aerosol	6

Tapes



Products

Adhesive Transfer Tape and Dispenser	108
Attachment Tapes	98–99
Duct Tapes	100–101
Electrical Tapes	108–109
Fastening Tapes	107
3M™ Scotchmate™	
Hook-and-Loop	107
3M™ Dual Lock™	107
Foam Tapes	100
Masking Tapes	95–97
Application Guide	95
233 and 233+	96
2727	97
2308	97
Packaging Tapes	101–105
Box Sealing	102–104
Dispensers	104–105
Filament	101
Label Protection	102
Paint Striping (Fine Line) Tapes	98
Retail Tape Products	110
Soft Edge Foam Masking Tapes (S.E.F.M.T./D.A.R.T.)	96
Specialty and Specialty Packaging Tapes	106
Vinyl Tape (471)	106

Tapes

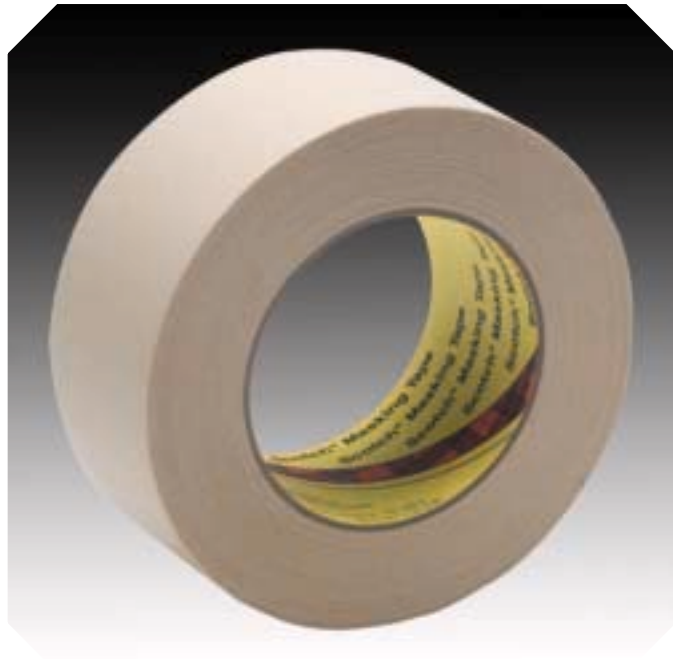



Automotive Masking Systems Application Guide

Products

Application— Area To Be Protected	Scotch® Performance Masking Tape 233+ PN26330-26344, 46334, 46338	Scotch® Automotive Refinish Masking Tape 233 PN06330-06346	3M™ Masking Papers PN06503- PN06738	3M™ Overspray Protective Sheeting/ 3M™ Paintable Plastic Sheeting PN06727-06728 PN06742	Scotch® Hand- Masker™ Prefolded Masking Film PN06845-06846 PN06848-06849	3M™ Overspray Masking Liquid PN06847- PN06857	3M™ Soft Edge Foam Masking Tape (D.A.R.T.) PN06296-06299	3M™ Trim Masking Tape PN06342, PN06345 PN06347-06349	Scotch® Fine Line Tape 218 PN06300-06308	Scotch® Plastic Tape 471 Blue PN06404-06409	Scotch® Fine Line Paint Striping Tape PN06312, 06314
Hood and Trunk	■	■	■	■	■	■	■				
Doors	■	■	■	■	■	■	■				
Grills and Bumpers	■	■	■	■	■	■					
Windshields and Windows	■	■	■	■	■	■		■			
Wheel Wells and Tires	■	■	■	■	■	■					
Door Jamb, Gas Caps, and Other Openings	■	■	■	■			■				
Mirrors and Hardware	■	■	■	■		■				■	
Lights, Reflectors and Moldings	■	■	■	■		■		■		■	
Graphics and Ornaments	■	■	■	■		■			■	■	
Painting Pinstripes	■	■	■	■					■	■	■
Open Areas	■	■	■	■	■						
Engine Compartment	■	■	■	■	■	■*					■

* 3M™ Overspray Masking Liquid-Wet formula only.

Masking Tapes

3M™ Universal Soft Edge Foam Masking Tape

- A 28 mm wide foam tape to be used for masking A-posts, door jambs, tailgates and all aperture openings of a vehicle which need to be sealed during the painting operation.
- Provides a “soft edge” to prevent tape lines in the jamb areas.



Part Number	Roll Size	Quantity Per Case
051131-06296	28mm x 20m 1" x 21.8 yds.	6

3M™ Soft Edge Foam Masking Tape (D.A.R.T.)

- A foam tape designed to be used in masking door jambs, hood or deck lid openings or other areas of a vehicle which need to be sealed during the painting operation.
- Provides a “soft edge” to prevent tape lines in the jamb areas.



Part Number	Diameter	Roll Size	Boxes Per Case
051131-06297	12mm (1/2")	54.6 yds. (50m)	6
051131-06298	19mm (3/4")	27.3 yds. (25m)	6

Scotch® Automotive Refinish Masking Tape 233

- Designed expressly for the professional auto refinish painter.
- Conformable, hugs curves and contours.
- Goes on quickly and easily, sticks at a touch and stays put.
- Every feature perfectly balanced to give outstanding masking results.



Part Number	Size	Rolls Per Case
021200-06330	1/4" x 60 yds. Bulk	144
021200-06332	1/2" x 60 yds. Bulk	72
021200-06334	3/4" x 60 yds. Bulk	48
021200-06335	7/8" x 60 yds. Bulk	48
021200-06336	1" x 60 yds. Bulk	36
021200-06338	1-1/2" x 60 yds. Bulk	24
021200-06340	2" x 60 yds. Bulk	24
021200-06341	3" x 60 yds. Bulk	12
021200-06343	1/8" x 60 yds. Boxed	12
021200-06344	1/4" x 60 yds. Boxed	12
021200-06346	1/2" x 60 yds. Boxed	12

Scotch® Performance Masking Tape 233+

- High performance masking tape designed to exceed the needs of today's collision repair shops.
- Highly conformable and has a specially formulated adhesive system which offers improved adhesive transfer resistance on rubber moldings and painted surfaces.
- Performs consistently under a variety of climactic conditions.
- Provides outstanding paint lines and a controlled, consistent unwind.



Part Number	Size	Rolls Per Case
051131-26330	6mm x 55m Bulk (1/4" applications)	96
051131-26332	12mm x 55m Bulk (1/2" applications)	48
051131-26334	18mm x 55m Bulk (3/4" applications)	48
051131-26335	21mm x 55m Bulk (7/8" applications)	40
051131-26336	24mm x 55m Bulk (1" applications)	24
051131-26338	36mm x 55m Bulk (1-1/2" applications)	16
051131-26340	48mm x 55m Bulk (2" applications)	12
051131-26341	72mm x 55m Bulk (3" applications)	8
051131-26343	3mm x 55m Boxed (1/8" applications)	12
051131-26344	6mm x 55m Boxed (1/4" applications)	12

Scotch® Performance Masking Tape 233+

- Highly conformable.
- Improved adhesive transfer resistance on rubber and plastic moldings.
- Controlled, consistent unwind.
- Outstanding paint lines.
- Individually wrapped.

Part Number	Size	Rolls Per Case
051131-46334	18mm x 55m	48
051131-46338	36mm x 55m	24

Masking Tapes

3M™ Trim Masking Tape

- Designed to lift the molding from the vehicle and protect the backside from paint, allowing complete paint coverage under the molding.
- Works particularly well on flush mount windshield, sidelight and back glass moldings.
- Saves time, labor, and the cost of removing and installing new moldings.



Part Number	Description	Kits Per Case
051131-06342	Introductory Kit — Consists of 1 Roll Each of PN06345, 06347, 06348 and 06349	1

Part Number	Size	Rolls Per Case
051131-06345	2" x 10.94 yds. (5mm hard band)	6
051131-06347	2" x 10.94 yds. (7mm hard band)	6
051131-06348	2" x 10.94 yds. (15mm hard band)	6
051131-06349	2" x 10.94 yds. (10mm hard band)	6

Tartan™ Paper Tape 000

- General use masking tape.
- Seaming masking paper and film.
- Tacking masking paper and film.



Part Number	Size	Rolls Per Case
051131-06532	3/4" x 60 yds. (18mm x 55m) Bulk	48
051131-06534	1-1/2" x 60 yds. (36mm x 55m) Bulk	24
051131-06535	2" x 60 yds. (48mm x 55m) Bulk	24

Highland™ Masking Tape 2727

- An automotive refinish masking tape designed with balanced construction for consistent unwind, conformability and easy tear.
- Available through authorized distributors. Please inquire with your distributor, contact your local 3M Sales Representative or contact 3M.



Part Number	Size	Rolls Per Case
051131-06541	18mm x 55m	48
051131-06542	36mm x 55m	24
051131-06543	48mm x 55m	24
051131-06544	24mm x 55m	36

3M™ Masking Tape 2308

- General purpose paint masking tape.
- Designed for non-critical area applications.
- Crepe backing provides good handling and conformability.
- Available through authorized distributors. Please inquire with your distributor, contact your local 3M Sales Representative or contact 3M.



Part Number	Size	Rolls Per Case
051131-06545	18mm x 55m	48
051131-06547	36mm x 55m	24
051131-06548	48mm x 55m	24

3M™ Masking Tape 2308

- Consistent adhesive coating.
- Adhesive transfer resistance.
- Consistent unwind.
- Leaves and excellent paint edge.
- Individually wrapped.

Part Number	Size	Rolls Per Case
051131-46545	18mm x 55m	48
051131-46547	36mm x 55m	24

Scotch-Blue™ Painter's Tape for Multi-Surfaces 2090

- Designed for short-term vehicle storage applications.
- Synthetic adhesive system provides UV stability and adhesive transfer resistance for up to seven days after application.
- Controlled crepe paper backing makes tape conformable and smooth for use when masking around damaged window, door and trunk openings.
- Ideal for use with the 3M™ Hand-Masker™ Dispenser (PN06799) and Scotch® Prefolded Draping Film Rolls (PNs 06844, 06848, 06852, and 06853).



Part Number	Size	Rolls Per Case
051115-06817	3/4" x 60 yds.	48
051115-06818	1" x 60 yds.	36
051115-06819	1-1/2" x 60 yds.	24
051115-06820	2" x 60 yds.	24

Paint Striping Tapes

Scotch® Fine Line Tape 218

- Has a special processed film backing that allows taping over freshly painted acrylic lacquer or enamel surfaces sooner and with less chance of imprint damage.
- This polypropylene film tape provides the finest color separation line possible in multi-color striping applications.
- Can be used for lettering, striping, and two-tone separation lines in all types of trucks and auto refinishing accounts.
- **NOT** designed for outdoor application.



Part Number	Size	Rolls Per Case
021200-06300	1/8" x 60 yds.	12
021200-06301	1/4" x 60 yds.	12
021200-06302	3/8" x 60 yds.	12
021200-06303	1/2" x 60 yds.	12
021200-06305	3/4" x 60 yds.	12
021200-06306	1/16" x 60 yds.	12
021200-06307	3/16" x 60 yds.	12
021200-06308	3/32" x 60 yds.	12

Scotch® Fine Line Paint Striping Tape

- A specially engineered tape that is slit to provide pull-out pieces for paint striping.
- Can be applied over freshly painted acrylic lacquer or enamel surfaces sooner and with less chance of imprinting.
- This polypropylene film tape is excellent for multi-color striping application.
- Each roll is 1" x 550".



Part Number	Size	Rolls Per Case
021200-06312	2 Pull-Outs 1/16" and 3/32"	12
021200-06314	8 Pull-Outs 1/16" Each	12

Scotch® Plastic Tape 471 Blue

- This uniquely constructed vinyl backed tape offers outstanding paint line definition along with excellent holding power for critical masking operations including sharp curves, over rivets and into seams.
- Tape is packaged in individual poly bags.



Part Number	Size	Rolls Per Case
051131-06404	1/8" x 36 yds.	12
021200-06405	1/4" x 36 yds.	12
051131-06408	1/2" x 36 yds.	12
051131-06409	3/4" x 36 yds.	12

Attachment Tapes

3M™ Automotive Attachment Tape

- A gray, closed-cell acrylic foam tape with a red release liner.
- Attaches emblems, nameplates, badges, lightweight moldings and trim.
- Individually packaged in recyclable plastic storage container.
- Not recommended for medium to heavyweight trim attachment. For medium to heavyweight trim attachment 3M recommends our thicker 3M™ Automotive Acrylic *Plus* Attachment Tapes (PNs 06382-06384, 06386 and 06397).



Part Number	Color	Size	Thick-ness	Rolls Per Case
021200-06377	Gray	1/2" x 20 yds.	.8mm .030"	12
021200-06378	Gray	7/8" x 20 yds.	.8mm .030"	12

3M™ Automotive Attachment Tape

- White acrylic foam tape that is .045" thick.
- O.E.M approved for the attachment of body side moldings, fascia nerf strips, bumper trim, wheel lip and door edge moldings and a wide variety of other trim components.
- More durable and stronger than PNs 06377 and 06378.
- Resists stress.
- Gives good initial and cold temperature adhesion.
- Individually packaged in a recyclable plastic container.
- For optimum adhesion to plastic parts use 3M™ Automotive Adhesion Promoter (PN06396).



Part Number	Color	Size	Thick-ness	Rolls Per Case
021200-06380	White	1/2" x 20 yds.	1.2mm .045"	12
021200-06381	White	7/8" x 20 yds.	1.2mm .045"	12

Attachment Tapes

3M™ Automotive Acrylic Plus Attachment Tape

- Black Acrylic Plus Tape that is .045" thick.
- O.E.M. approved for the attachment of body side moldings, fascia nerf strips, bumper trim, wheel flares rocker panel moldings, claddings and a wide variety of other medium to heavyweight trim components.
- More durable and much stronger than other foam tapes.
- Resists stress.
- Gives excellent initial and cold temperature adhesion.
- Individually packaged in a recyclable plastic container.
- For optimum adhesion to plastic parts use 3M™ Automotive Adhesion Promoter (PN06396).



Part Number	Color	Size	Thick-ness	Rolls Per Case
051131-06382	Black	1/2" x 20 yds.	1.2mm .045"	12
051131-06383	Black	7/8" x 20 yds.	1.2mm .045"	12
051131-06384	Black	1/2" x 5 yds.	1.2mm .045"	12
051131-06386	Black	1/4" x 20 yds.	1.2mm .045"	12

3M™ Nameplate Repair Tape

- Gray acrylic foam tape that is .030" thick.
- Adheres emblems, nameplates, and door edge trim to vehicle surfaces.
- Thinner to offer a flush fit of emblems and nameplates to the vehicle surface.
- For lightweight parts only.
- Not recommended for the repair of body side moldings and heavier weight trim components. For medium to heavyweight trim attachment, 3M recommends our thicker (45-60 mils thick) repair tapes (PNs 06382-06384, 06386 and 06397).
- Individually packaged in a recyclable plastic container.



Part Number	Color	Size	Thick-ness	Rolls Per Case
051131-06385	Gray	.236" x 5 yds.	.8mm .030"	12

3M™ Automotive Adhesion Promoter

- Liquid primer packaged in convenient, single-use applicator packets.
- Strongly recommended for use with all automotive attachment tapes for the repair of larger exterior body side moldings, trim, claddings, etc. made of injection molded plastics such as TPO and RIM.
- Can be applied on common low surface energy plastics used for automotive dash and interior trim applications (TPO, PPO, PP, PC, PC + ABS, etc.).
- One packet covers approximately 150 square inches of substrate at the recommended coating thickness.



Part Number	Container Size	Quantity Per Box	Boxes Per Case
051131-06396	2.5 cc	25	4

3M™ Automotive Acrylic Plus Attachment Tape

- Black acrylic foam tape that is .060" thick.
- Intended for more demanding attachment applications requiring a thicker tape.
- Ideally suited for attachment of large exterior moldings and claddings such as the injection-molded plastic trim made of TPO and/or painted RIM materials.
- O.E.M. approved for the attachment of body side moldings, bumper trim, wheel flares, claddings and a wide variety of other heavyweight trim components.
- More durable and much stronger than other foam tapes.
- Resists stress with high conformability to compensate for part-to-body mismatch.
- Gives excellent initial and cold temperature adhesion.
- Individually packaged in a recyclable plastic container.
- Use of PN06396 Adhesion Promoter is recommended for plastic and injection-molded parts for optimum adhesion.



Part Number	Color	Size	Thick-ness	Rolls Per Case
051131-06397	Black	1/2" x 10 yds.	1.5mm .060"	12

Foam Tapes

3M™ Scotchfoam™ Black Vinyl Foam Tape

- A bulk packed tape which is used to shim up weather stripping and seals dust, air and water leaks on trunks, doors and station wagon tailgates.
- Can also be used in truck repair shops for sealing repair panels.



Part Number	Tape No.	Size	Thick-ness	Rolls Per Case
051131-06370	4504	3/4" x 18 yds.	1/4"	12
021200-03320	4504	1" x 18 yds.	1/4"	9
051131-06375	4508	3/4" x 36 yds.	1/8"	12

3M™ EPDM Rubber Weatherstrip (One Step), with Self Adhesive

- For use on car doors, trunks, hatchbacks or wherever a supplemental weatherstrip is needed.
- Keeps out water, wind noise, dust, dirt, etc.
- OEM approved 3M™ Acrylic Foam Tape for easy installation.
- No glues or cements needed.
- Two styles, "bulb" and "L".

Part Number	Description/ Size	Rolls Per Case
079996-08650	Hollow "Bulb" Style 7/8" x 3/4" x 8'	6
079996-08651	Solid "L" Style 11/16" x 1/2" x 8'	6

3M™ Scotch-Mount™ Double-Coated Urethane Foam Tape White

- Applies to any clean, dry, solid surface with instant adhesion and high holding power.
- Resists loosening due to vibration.
- Retains high strength even under extreme cold conditions.



Part Number	Size	Thick-ness	Rolls Per Case
021200-06450	1/2" x 36 yds.	1/8"	18
021200-06451	3/4" x 36 yds.	1/8"	12
021200-06452	1" x 36 yds.	1/8"	9
021200-06453	1/2" x 36 yds.	1/16"	18
021200-06454	3/4" x 36 yds.	1/16"	12
021200-06455	1" x 36 yds.	1/16"	9
021200-06456	1/2" x 72 yds.	1/32"	18
021200-06457	3/4" x 72 yds.	1/32"	12
021200-06458	1" x 72 yds.	1/32"	9

Duct Tapes

Scotch® Automotive Transparent Duct Tape

- Makes your repair less obvious.
- Will not fall apart in extreme temperatures and harsh UV conditions.
- Lasts six times longer than other ordinary duct tapes.



Part Number	Size	Quantity Per Case
051131-03408	1-1/2" x 4 yds.	24
051131-03451	1.88" x 15 yds.	12

3M™ Duct Tape 6969

- An industrial strength cloth duct tape used for demanding duct tape applications.
- Strong backing, abrasion resistant, tears straight and easy without curling.
- Tack-free edges.
- Designed for applications such as reinforcing, bundling, sealing, holding, moisture proofing and various miscellaneous applications.



Part Number	Color	Size	Rolls Per Case
051131-06969	Silver	2" x 60 yds.	24

Scotch® Automotive Transparent Duct Tape — Gravity Feed Display



Part Number	Tape Size	Displays Per Case
051131-86741	1.88" x 15 yds.	1

Duct Tapes

Scotch® Cloth Tape 390

- Designed for medium strength and moisture resistance applications.
- High instant adhesion.
- Used for sealing, patching and a variety of repair applications where flexibility, conformability and a moisture-proof tape is required.
- The silver tape can also be used for a variety of automotive air conditioning and heater line sealing applications.



Part Number	Color	Size	Rolls Per Case
021200-06970	Olive	2" x 60 yds. Bulk	24
021200-06971	Silver	2" x 60 yds. Bulk	24

3M™ Duct Tape 3939

- A heavy-duty cloth duct tape.
- Tears straight and easy without curling.
- Tack-free edges.
- Designed for applications such as patching, bundling, sealing and temporary repair.

Part Number	Color	Size	Rolls Per Case
051131-06975	Silver	48mm x 54.8m	24

3M™ Duct Tape 3900

- A general purpose cloth duct tape.
- Offers strong tack, good adhesion and conformability.
- Designed for applications such as wrapping, sealing, bundling and holding applications.



Part Number	Color	Size	Rolls Per Case
051131-06976	Silver	48mm x 54.8m	24
021200-49828	Yellow	48mm x 54.8m	24
021200-49829	White	48mm x 54.8m	24
021200-49830	Red	48mm x 54.8m	24
021200-49831	Olive	48mm x 54.8m	24
021200-49832	Blue	48mm x 54.8m	24
021200-49833	Black	48mm x 54.8m	24

Scotch® Automotive Cloth Tape

- A cotton cloth tape with a polycoated backing.
- Used for sealing air conditioning lines, interior door panels, access holes and various other automotive body sealing applications.
- Highly conformable, moisture resistant.
- Very good for patching and reinforcing applications on vinyl and canvas material.

Part Number	Color	Size	Rolls Per Case
06980*	Olive	2" x 20 yds.	24

*UPC Number is 021200-95723

3M™ Vinyl Duct Tape 3903

- Easy to unwind.
- Easy to tear.
- Leaves fewer residues.
- Use for sealing, protection from moisture, identification and fixturing.



Part Number	Color	Size	Rolls Per Case
051131-06984	Gray	2" x 50 yds.	24

Scotch® Color Cloth Tape

- Economical 9 mil thick tape.
- Constructed of polyethylene film bonded to a strong polycotton blend cloth.
- Conformable.
- Provides good weather and moisture resistance.
- For mending vinyl seat cushions, canvas boat covers, plastic tarps, etc.

Part Number	Cat #	Color	Size	Rolls Per Case
051131-58709	330	Black	2" x 60 yds.	8

Filament Tapes

Scotch® Filament Tape 898

- Super strength.
- High performance.
- Adheres instantly.
- Excellent for bundling tail pipes and sealing and reinforcing cartons containing heavy automotive parts for shipment.



Part Number	Size	Rolls Per Case
051131-06893	12mm x 55m Boxed	12
051131-06894	18mm x 55m Boxed	12
051131-06895	24mm x 55m Boxed	12
051131-06896	12mm x 55m Bulk	72
051131-06897	18mm x 55m Bulk	48
051131-06898	24mm x 55m Bulk	36

Scotch® Filament Tape 893

- An economical filament tape.
- For utility and miscellaneous packaging where non-critical application is apparent.



Part Number	Size	Rolls Per Case
051131-06937	12mm x 55m Bulk	72
051131-06938	18mm x 55m Bulk	48
051131-06939	24mm x 55m Bulk	36

Label Protection Tapes

Scotch® Labelgard™ Film Tape 821

- Write-on surface.
- Acetate film.
- Matte finish.
- Acrylic adhesive.
- Pink tint.
- Use with Scotch® Packaging List Tape Dispenser M-727 (PN06944).

Part Number	Size	Rolls Per Case
021200- 04134	5" x 72 yds.	8

Scotch® Labelgard™ Tape 8210

- Attach and protect address labels.
- Non-glare, matte finish.
- Writable surface.
- Use with Scotch® Label Protection Dispenser M-707 (PN06923).



Part Number	Size	Quantity Per Case
021200- 06888	4" x 72 yds.	8

Scotch® Packing List Tape 8240

- Attach and protect packing lists.
- Resists scuffing, moisture and abrasion.
- See-through, adhesive-free window.
- Use with Scotch® Pouch Tape Dispenser M-727 (PN06944).



Part Number	Pouch Size	Pouches Per Roll	Rolls Per Case
021200- 06947	5" x 6"	500	8

3M™ ScotchPad™ Packing List Tape Pad 8240P

- Attach and protect packing lists.
- Convenient pad form.
- Portable, requires no dispenser.
- "Packing List Enclosed" printed in bright orange border.
- See-through, adhesive-free window.
- 5" x 6" sheets, 25 applications per pad.

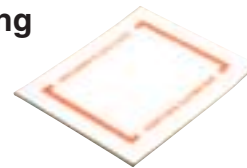

Part Number	Sheets Per Pad	Pads Per Carton	Cartons Per Case
051131- 06954	25	40	5

Packaging Tapes

Scotch® Packaging Tape Bonus Packs

- Designed with quality tapes and dispensers to meet your customers' packaging needs.
- Value-added, saving both time and money.



Part Number	Description	Quantity Per Case
051131- 06632	2 Rolls Scotch® Premium Heavy Duty Packaging Tape 3750 Clear 48mm x 50m with Scotch® Dispenser H-180 (BP1)	18
051131- 06635	12 Rolls Scotch® Premium Heavy Duty Packaging Tape 3750 Clear 48mm x 50m with Scotch® Dispenser H-122 (BP-6TC)	3
021200- 45287	4 Rolls Scotch® Heavy Duty Box Sealing Tape 375 Clear 48mm x 50m with Reusable Dispenser (PSD-2)	24

Scotch® Premium Heavy Duty Packaging Tape 3750

- Strong and thick for heavy duty package applications.
- Resists center seam splitting and tearing.
- Seals out moisture, dust and dirt.
- Aggressive packaging adhesive allows tape to stick instantly and hold tightly.
- Excellent performance in a wide range of environments and applications.
- Meets U.S. Postal and UPS regulations for standard packages.



Part Number	Color	Size	Rolls Per Case
051131- 06640	Clear	48mm x 50m	36
051131- 06642	Tan	48mm x 50m	36

Packaging Tapes

Scotch® Box Sealing Tape 355

- A thick, tough box sealing tape.
- Easy to handle.
- Sticks instantly to most boxes and cartons.
- This tape can be substituted for 3" gum sealing tape, staples or glue.

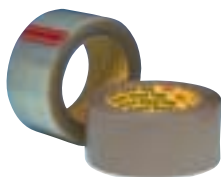

Part Number	Color	Size	Rolls Per Case
051131- 06650	Tan	36mm x 50m	48
051131- 06651	Tan	48mm x 5m	36

Scotch® Box Sealing Tape 371

- Conforms to box surfaces for a consistent, uniform seal with no water or sticky cleanup.
- Resists center seam splitting and seals out moisture, dust and dirt.
- Ideal for most packaging needs.



Part Number	Color	Size	Rolls Per Case
021200- 15872	Tan	48mm x 100m	36

Scotch® Packaging Tape 3710

- A strong film tape.
- Conforms to box surfaces for a consistent, uniform seal with no water or sticky cleanup.
- Resists center seam splitting and seals out moisture, dust and dirt.
- Ideal for most packaging needs.
- Meets U.S. Postal and UPS regulations for standard packages.



Part Number	Color	Size	Rolls Per Case
021200- 14765	Tan	48mm x 50m Bulk	36
021200- 14766	Clear	48mm x 50m Bulk	36
021200- 18813	Clear	48mm x 100m Bulk	36

Tartan™ Box Sealing Tape 3690

- A general purpose box sealing tape for light duty packaging, storage and sealing applications.
- A strong film tape.
- Conforms to box surfaces for a consistent uniform seal with no water or sticky cleanup.
- Resists center seam splitting and seals out moisture, dust and dirt.
- Ideal for most packaging needs.
- Meets U.S. Postal and UPS regulations for standard packages.



Part Number	Color	Size	Rolls Per Case
021200- 82862	Tan	48mm x 50m	36
021200- 82863	Tan	48mm x 100m	36
021200- 82864	Clear	48mm x 50m	36
021200- 82865	Clear	48mm x 100m	36

Scotch® Extreme Application Packaging Tape 8959 and 8959RD

- Extreme application packaging tape reinforced with continuous glass yarn in both the horizontal and vertical direction for added strength.
- Strong backing provides excellent abrasion, moisture and scuff resistance.
- Special formulated adhesive provides good adhesion to a wide variety of surfaces including metallic, plastic and fiberboard.
- Use for heavyweight shipping (up to 70 lbs., double-wall box) and overseas/export shipments.
- Use with Scotch® Heavy-Duty Dispenser H128 (PN06909).



Part Number	Size	Rolls Per Case
021200- 48140	50mm x 20m with Reusable Dispenser	12
021200- 55181	50mm x 20m Refill Roll	24
Bulk		
021200- 88228	50mm x 50m	18

Packaging Tape Dispensers

Scotch® Box Sealing Tape Dispenser H-320

- A quick, easy and inexpensive method for sealing cartons.
- Accommodates 2" rolls of box sealing tape.
- Lightweight, quick loading.
- Features a metal cutting edge for long life.

Part Number	For Use With Roll Size	Dispensers Per Case
021200-06908	2" width	6

Scotch® Box Sealing Tape Dispenser H-128

- For use with Scotch® Extreme Application Packaging Tapes shown above.
- For package sealing/closing operations.



Part Number	Dispensers Per Case
021200-06909	6

Scotch® Filament Tape Dispenser H-10

- Accommodates all listed widths of filament tapes shown on page 101.



Part Number	Dispensers Per Case
021200-06910	6

Scotch® Label Protection Dispenser M-707

- For address label applications.
- Applies and protects labels in one operation.
- Accommodates tape up to 4" wide.



Part Number	Dispensers Per Case
021200-06923	6

Scotch® Heavy-Duty Dispenser C-25

- A rugged, high-impact construction dispenser.
- Built-in tape drum that stays with the dispenser.
- Dispenses and cuts most filament, paper and aluminum tapes up to 1" wide.



Part Number	Dispensers Per Case
021200-06924	3

Scotch® Box Sealing Tape Dispenser H-122

- A lightweight and durable hand dispenser.
- For box sealing tapes up to 2" wide.



Part Number	Dispensers Per Case
021200-06925	6

Scotch® Pouch Tape Dispenser M-727

- Accommodates both our Scotch® Pouch Tape and our Scotch® Labelgard™ Tape.
- Accepts tape up to 5" wide.
- Unique streamline construction.
- Can be wall or bench mounted.

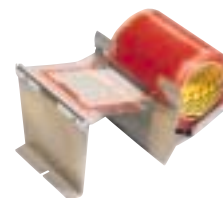

Part Number	Dispensers Per Case
021200-06944	6

Scotch® Filament Tape Hand Dispenser H-12

- Features a hand brake in the core.
- For box reinforcement and bundling applications.
- Made from high-impact, durable plastic.
- Handles filament tapes up to 1" wide.



Part Number	Dispensers Per Case
021200-06953	6

Packaging Tape Dispensers

Scotch® Box Sealing Tape Dispenser H-171

- Quick and easy dispensing of box sealing tape.
- Accommodates tape up to 2" wide.



Part Number
021200-06955

Dispensers Per Case
6

Scotch® Mainline Dispensers P-56 and P-56W

- Economical and versatile dispensers.
- For use with Scotch® paper and transparent tapes.
- Holds multiple rolls of tape up to a 6" wide capacity.
- Dispenser P-56W has the added benefit of a weight kit.



Part Number
051131-06964
051131-06965

Dispensers Per Case
1
1

Scotch® Box Sealing Tape Dispenser H-180

- Quickly and economically seals center seams of regular slotted containers.
- Easy to use, pistol grip, roll-on dispenser.
- Adjustable brake mechanism to control tape tension and delivery.
- Accommodates tape up to 2" wide on 3" core.
- Heavy-duty plastic and metal construction.



Part Number
021200-19008

Quantity Per Case
6

Tartan™ Tabletop Tape Dispenser HB-900

- Ideal for mailing, shipping and wrapping stations.
- Weighted for convenient one-hand dispensing.
- Tape capacity up to 1" wide.
- Accommodates 1" or 3" core tape rolls.
- Refillable.



Part Number
051131-06993

Dispensers Per Case
12

Tartan™ Hand-Held Filament Tape Dispenser HB-901

- Lightweight, heavy-duty construction.
- Dispenses tape up to 1" wide on a 3" core.
- Refillable.



Part Number
051131-06994

Dispensers Per Case
12

Tartan™ Hand-Held Box Sealing Tape Dispenser HB-902

- Compact, lightweight and easy to control.
- Handles tape rolls up to 2" wide by 60 yards long on a 3" core.
- Refillable.



Part Number
051131-06996

Dispensers Per Case
12

Tartan™ Pistol Grip Box Sealing Tape Dispenser HB-903

- Easy to use, one-hand box sealing tape dispenser.
- Has an adjustable braking mechanism.
- Holds tape up to 2" wide on a 3" core.
- Refillable.



Part Number
051131-06997

Dispensers Per Case
24

Specialty Tapes

Scotch® Thread Sealant and Lubricant Tape 48

- Rolls on dry; molds into pipe threads forming a leak-proof seal.
- Works on any automotive line, eliminates messiness of conventional materials.
- Unaffected by oils, transmission fluid or freon.
- Never dries out.
- Permanently lubricated joints never stick.



Part Number	Size	Rolls Per Case
054007-06192	1/4" x 260"	12
054007-06195	1/2" x 260"	12
054007-06196	1/2" x 520"	12

3M™ Squeak Reduction Tape 5430

- An ultra-high molecular weight polyethylene film tape designed for the automotive industry.
- Controls squeaks and rattles due to vibration or wear of metal and plastic materials.



Part Number	Size	Rolls Per Case
051131-06356	1" x 3 yds.	12

Scotch® Auto Body Repair Tape

- A practical, easy to use backup material for plastic filler on rust-out areas.
- Has extremely high-strength adhesive.
- Strong and rigid.
- Withstands weathering well.
- Thick aluminum backing.



Part Number	Size	Rolls Per Case
021200-06930	2" x 125"	12

Post-it® Labeling Tape 695 White

- A white, general purpose labeling tape that is easily removable.
- Use for shelf and bin marking and package identification.
- Works great for correction and cover-up work.



Part Number	Size	Rolls Per Case
051131-06950	3/4" x 36 yds.	48
051131-06951	2" x 36 yds.	24

Specialty Packaging Tapes

3M™ Vinyl Tape 471

- For lane and stall marking, protecting, mending, color-coding parts and pipe or hose lines.
- Retains true color brightness for prolonged periods.
- Twelve rolls per case.



Part Number	Color	Size
021200-06415	Black	1" x 36 yds. Boxed
021200-06420	Yellow	2" x 36 yds. Boxed
021200-06421	White	2" x 36 yds. Boxed
021200-06423	Green	2" x 36 yds. Boxed
021200-06424	Red	2" x 36 yds. Boxed
021200-06425	Black	2" x 36 yds. Boxed
021200-06466	White	3" x 36 yds. Bulk
021200-06467	Black	3" x 36 yds. Bulk
021200-06468	Green	3" x 36 yds. Bulk
021200-06469	Red	3" x 36 yds. Bulk
021200-06470	Yellow	3" x 36 yds. Bulk

Scotch® Transparent Tape 600

- An economical, general purpose tape.
- Crystal clear, non-yellowing transparent tape.
- Used for a variety of sealing, protecting and holding applications.



Part Number	Size	Rolls Per Case
051131-06681	1" x 72 yds. Bulk	36
051131-06821	1/2" x 72 yds. Boxed	12
021200-06941	3/8" x 72 yds. Boxed	12
021200-06943	3/4" x 72 yds. Boxed	12

Scotch® Printable Flatback Tape

- To be used for shelf labeling, bin marking and packaging identification.



Part Number	Color	Size	Rolls Per Case
021200-06875	White	3/4" x 60 yds.	48

3M™ Scotchmate™ and Dual Lock™ Fastening Systems

3M™ Scotchmate™ and Dual Lock™ Assortment Pack

- An assortment consisting of 1 each of three 3M™ Scotchmate™ Hook-and-Loop Mini-Packs and three 3M™ Dual Lock™ Mini-Packs.
- Each mini-pack has both sides of the interlocking fastener together in a single, convenient dispenser box.
- You can never run out of ways to use 3M™ Scotchmate™ Hook-and-Loop and Dual Lock™ Fasteners:
 - Hold down boat covers.
 - Attach carpets and upholstery.
 - Attach electronics (even marine).
 - Secure boat cushions.
 - Attach down floor mats.
 - Hold down floor mats.
 - Hold work lights and tools.
 - Mount picture frames on cabin walls.
- Assortment Pack includes 1 each of the 3M™ Scotchmate™/Dual Lock™ Fasteners:
 - White Hook-and-Loop Sew-on 3M™ Scotchmate™ Fasteners.
 - Black Hook-and-Loop Sew-on 3M™ Scotchmate™ Fasteners.
 - Black Hook-and-Loop Pressure-Sensitive 3M™ Scotchmate™ Fasteners.
 - Black 3M™ Dual Lock™ Very-high-bond Adhesive, UV and Plasticizer Resistant Fasteners.
 - Clear 3M™ Dual Lock™ Very-high-bond Adhesive, UV and Plasticizer Resistant Fasteners.
 - Black 3M™ Dual Lock™ Pressure Sensitive Fasteners.



3M™ Scotchmate™ Hook-and-Loop Fastening Systems



3M™ Dual Lock™ Fastening Systems

Part Number	Description	Assortments Per Case
051131-06462	Assortment Pack	1

3M™ Scotchmate™ Hook-and-Loop Mini-Pack Rolls

- Premium performance adhesive system.
- Attractively packaged for counter display.
- Comprised of two woven nylon strips, one of hook material and one of loop material.
- Five rolls per case.
- Roll size is 1" x 4.9 yds./1 roll each of both sides included.
- Pressure-sensitive rubber adhesive on PNs 06481 and 06488 bonds to most surfaces.



Part Number	Product/Color	Description	Temperature
051131-06464	MP-3401/02 White	Sew-On	250°F Continuous
051131-06465	MP-3401/02 Black	Sew-On	250°F Continuous
051131-06481	MP-3526/27	Pressure-Sensitive	120°F Continuous 158°F Intermittent
051131-06488	MP-3526/27 White	Pressure-Sensitive	120°F Continuous 158°F Intermittent

3M™ Scotchmate™ Hook-and-Loop Fastening System

- Premium performance adhesive system.
- Includes twelve 1" x 12" mated strips.
- Attractively packaged for counter or pegboard display.
- Comprised of two woven nylon strips, one of hook material and one of loop material.



Part Number	Strips Per Box	Boxes Per Case
051131-06480	12	6

3M™ Dual Lock™ Mini-Pack Fastening Systems

- Available with pressure-sensitive adhesive.
- Improved tensile strength.
- Best when hundreds of closures are anticipated.
- Solvent and water resistant.
- Available in black or clear.
- Five rolls per case.
- Roll size is 1" x 4.9 yds./1 roll each of both sides included.
- Pressure-sensitive adhesive bonds to most surfaces.



Part Number	Product/Color	Description	Temperature
051131-06483	MP-3541/42 Black	Pressure-Sensitive	120°F Continuous 158°F Intermittent
051131-06484	MP-3551/52 Black	Very High Bond Scotch® VHB Adhesive, UV and Plasticizer Resistant	Up to 200°F
051131-06463	MP-3560 Clear	Very High Bond Scotch® VHB Adhesive, UV and Plasticizer Resistant	Up to 200°F

Tapes

Adhesive Transfer Tape and Dispenser

Scotch® ATG Adhesive Systems

- Hold, attach, bond, laminate, tab, join, fasten, mount, splice or seal nearly any surface — paper, foils, films, fabrics, glass, foams, plastics, metal, painted surfaces and wood.
- Thin and tacky on both sides; one side adheres to applied surface, the other side is immediately ready to join a second surface.
- Provides instant tack and strong constant bond.



Scotch® ATG Dispenser 752

- Designed for use with our Scotch® ATG Adhesive Transfer Tape (PNs 06491-06494) for easy dispensing.



Part Number
021200-**06927**

Dispensers Per Case
6

Part Number	Tape No.	Mil Thickness	Size	Rolls Per Case
051131- 06491	924	2.0	1/2" x 36 yds.	72
051131- 06492	924	2.0	3/4" x 36 yds.	48
051131- 06493	969	5.0	1/2" x 18 yds.	72

Electrical Tapes

Scotch® Vinyl Plastic Electrical Tape Super 33+

- The first and only 7 mil “one tape for all jobs.”
- It wraps and holds in all weather and will continue to perform in sub-zero temperatures or in continuous temperature environments up to 105°C (220°F).
- Conforms remarkably well.
- Resistant to oil, water, wear, chemicals and solvents.
- U.L. listed.
- The professional’s choice.

Part Number	Size	Rolls Per Box	Rolls Per Case
054007- 06130	3/4" x 20'	10	100
054007- 06132	3/4" x 66'	10	100
054007- 06133	3/4" x 52'	10	100

Scotch® Vinyl Plastic Electrical Tape Super 88

- Handles well in sub-zero temperatures (-18°C to -105°C).
- Excellent conformability.
- Faster build-up.
- 8.5 mil thickness.
- U.L. listed.
- The professional’s choice.



Part Number	Size	Rolls Per Box	Rolls Per Case
054007- 06143	3/4" x 66'	10	100

Electrical Tapes

Scotch® Electrical Tape Displays

- Scotch® Vinyl Plastic Electrical Tape Super 33+ and Scotch® Vinyl Plastic Electrical Tape Super 88 now available in 20 roll displays.

Part Number	Individual Roll Size/ Part Number	Rolls Per Display
051128- 55385	3/4" x 66' (06132)	20
051128- 55386	3/4" x 66' (06143)	20

Scotch® 700 Commercial Black Tape

- Temperature range of -10°C to -90°C.
- Moisture proof.
- Abrasion resistant.
- Flame retardant
- Flexible and conformable.
- U.L. listed.

Part Number	Size	Rolls Per Case
054007- 04218	3/4" x 66'	100

Highland™ Vinyl Plastic Electrical Tape

- Abrasion and moisture resistant.
- Flame retardant.
- Flexible and conformable.
- Economical.
- 7 mil thickness.
- U.L. listed.



Part Number	Size	Rolls Per Box	Rolls Per Case
054007- 06138	3/4" x 66'	10	100

Tartan™ Vinyl Electrical Tape 1710

- Economical, general purpose vinyl electrical tape.
- 7 mil thickness.
- U.L. listed.
- Flame retardant.



Part Number	Size	Rolls Per Case
49656*	3/4" x 60'	100

* UPC Number is 054007-50588

Scotch® Vinyl Plastic Electrical Tape 81

- Specially designed for auto repairs.
- Excellent for splicing wires, harnessing cable, wrapping hose and more.



Part Number	Size	Rolls Per Box	Rolls Per Case
054007- 06100	3/4" x 20'	10	100
054007- 06101	3/4" x 60'	10	100

Scotch® 130C Premium Linerless Rubber Splicing Tape

- Designed to offer ultimate in protection of electrical wiring and connectors from shorts and failures caused by moisture and corrosion.
- Self-bonding, moisture resistant, weather resistant.
- Will not crack or embrittle in ultraviolet light or cold temperature.
- High degree of stretch allows tight, conformable wrapping of wires and connectors.

Part Number	Size	Rolls Per Case
054007- 41717	3/4" x 30'	10

3M™ Linerless Electrical Rubber Tape 2242

- Designed to offer ultimate in protection of electrical wiring and connectors from shorts and failures caused by moisture and corrosion.
- Self-bonding, moisture resistant, weather resistant.
- Will not crack or embrittle in ultraviolet light or cold temperature.
- High degree of stretch allows tight, conformable wrapping of wires and connectors.



Part Number	Size	Rolls Per Case
054007- 06165	3/4" x 15'	24

Scotch® Electrical Moisture Sealant Tape

- Quick and easy method of moisture-proofing electrical connections.
- Protects against vibration, road grime and abrasion.
- Self-fusing, rubber-based thin insulating mastic compounds laminated to a flexible, all-weather PVC backing.
- Designed for moisture sealing of electrical connections up to 600 volts.

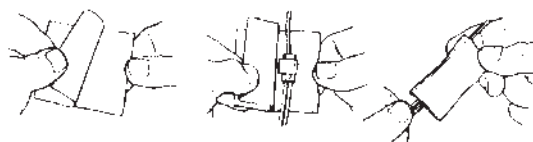

Part Number	Patch Size	Patches Per Box	Boxes Per Case
054007- 06149	2-1/2" x 2-1/2"	25	10

Retail Tape Products

Scotch® Automotive Tapes — Retail

- A variety of Scotch® tapes packaged especially for the Retail Automotive Market.
- Each roll is individually packaged in an attractive pegboardable pack for easy display.
- The following tapes are now available:

Scotch® Clear Repair Tape

- Repairs torn vinyl car covers.
- Offers tight, water resistant seals on many surfaces.



Part Number	Size	Rolls Per Case
051131-03405	1" x 150"	24

Scotch® Mounting Tape

- Mounts small items to dashboard or other interior surfaces.
- Self-sticking adhesive on both sides.



Part Number	Size	Rolls Per Case
051131-03410	1/2" x 75"	24

3M™ Automotive Pickup Camper Tape

- Seals gaps between pickup truck cab and bed rails.
- Helps to insulate.
- Adhesive-backed foam seals out dust, moisture and vibrations.

Part Number	Size	Rolls Per Case
051131-03420	1-1/4" x 10 yds.	6

3M™ Lens Repair Tape

- Designed for the temporary repairs of broken or cracked taillights, parking lights and side directional lights.



Part Number	Size	Color	Rolls Per Case
051131-03441	1-7/8" x 60"	Red	24
051131-03442	1-7/8" x 60"	Amber	24

3M™ Scotch-Mount™ Molding Tape

- Ideal for attaching vehicle body side moldings, trim and emblems.
- Strong bonding.
- Easy to use.
- Cut to size, no mess.



Part Number	Size	Rolls Per Case
051131-03609	1/2" x 5'	24
051131-03614	1/2" x 15'	24
051131-03615	7/8" x 5'	24
051131-03616	7/8" x 15'	24

Scotch® Super 33+ Electrical Tape

- Professional grade.
- A general purpose, flame-retardant, vinyl tape.
- Resists abrasion, weather, water, solvent splashes and many chemicals.
- U.L. listed.



Part Number	Size	Rolls Per Case
054007-03744	3/4" x 300"	24

3M™ ScotchPad™ Hang Tabs

- Clear, sturdy plastic and pressure-sensitive adhesive that sticks to most surfaces.
- Comes on a convenient, self-sticking pad.
- Handy for hanging shrink-wrap packages, as well as in-store repair of damaged packaging.



Part Number	Description	Hang Tabs Per Pad	Pads Per Case
021200-62013	3M™ ScotchPad™ 1075 2" x 2" Delta Hole Hang Tab	10	500
021200-62014	3M™ ScotchPad™ 1076 2" x 2" Round Hole Hang Tab	10	500
021200-62225	3M™ ScotchPad™ 1074 1" x 2" Mini Hang Tab	10	1000

Masking Systems



Products

Hand Masking.....	115–116
Blades	115
Dispensers	115–116
Films	116
Kits.....	116
Masking Equipment....	114–115
Apron Tapers	114–115
Maskers.....	114–115
Masking Paper.....	113
Overspray Masking Liquid... ..	116
Overspray Protective Sheeting (Plastic Sheeting)	113

Masking Systems



3M *Innovation*

Masking Paper

Scotch® Steel Gray Masking Paper

- Strong, flexible and pliable.
- Formulated to resist penetrations of solvents, lacquers or enamels.
- Variety of sizes: 12" to 18" widths for general masking — 3" or 6" widths for headlights, taillights, door jambs and bumpers.



Part Number	Size	Rolls Per Case
021200-06503	3" x 1000'	6
021200-06506	6" x 1000'	6
021200-06509	9" x 1000'	4
021200-06512	12" x 1000'	3
021200-06515	15" x 1000'	2
021200-06518	18" x 1000'	2
021200-06524	24" x 1000'	1
021200-06530	30" x 1000'	1
021200-06536	36" x 1000'	1

3M™ White Masking Paper

- Specifically manufactured for the automotive aftermarket.
- Offers excellent protection against bleed-thru from urethane, enamels, lacquers and base coat/clear coat paint systems.
- Tightly bonded paper protects against fiber contamination and conforms excellently.



Part Number	Size	Rolls Per Case
051131-06508	12" x 180'	12
051131-06537	6" x 750'	6
051131-06538	12" x 750'	3
051131-06539	18" x 750'	2
051131-06540	36" x 750'	1

Scotch® Bold Brick Masking Paper

- A high-density masking paper specifically manufactured for the automotive aftermarket.
- Offers very good paint penetration resistance from all solvents used in today's sealers, lacquer and enamel paints and clear coat systems.
- Protects against dust contamination from paper fibers.
- Provides excellent conformability.
- Holds up well under wet sanding conditions.



Part Number	Size	Rolls Per Case
051131-06603	3" x 750'	6
021200-06606	6" x 750'	6
051131-06609	9" x 750'	4
021200-06612	12" x 750'	3
021200-06618	18" x 750'	2
051131-06624	24" x 750'	1
021200-06636	36" x 750'	1

3M™ Scotchblok™ Masking Paper

- A tightly bonded, specially coated masking paper specifically manufactured for the automotive aftermarket.
- Offers the ultimate penetration resistance from all solvents used in today's sealers, lacquer and enamel paints and clear coat systems.
- Eliminates dust contamination from paper fibers.
- Provides excellent conformability.
- Holds up well under wet sanding conditions.
- Distinctive gold color for easy identification.



Part Number	Size	Rolls Per Case
051131-06706	6" x 750'	6
051131-06712	12" x 750'	3
051131-06715	15" x 750'	2
051131-06718	18" x 750'	2
051131-06736	36" x 750'	1
051131-06726	6" x 180'	12
051131-06729	9" x 180'	12
051131-06732	12" x 180'	12
051131-06738	18" x 180'	12

3M™ Overspray Protective Sheeting (Now Paintable)

- Uniquely formulated to provide excellent paint adherence.
- High-density, tear-resistant, clear film.
- Durable film that is treated for excellent paint overspray adhesion.
- Twelve foot film folded to three feet for easy one-person application.
- Sixteen foot width accommodates larger vehicles (i.e. mini-vans, sport utilities, pick-up trucks, etc.) for more effective overspray protection.
- Use with Masker PN06780.



Part Number	Size	Rolls Per Case
051131-06727	12' x 400'	1
051131-06728	16' x 400'	1
051131-06742	20' x 250' Bulk	1

Masking Equipment

3M™ Overspray Protective Sheeting Masker



- Portable masker designed to dispense 3M™ Overspray Protective Sheeting (PN06727 or 06728) and 3M™ Paintable Plastic Sheeting (PN06739 or 06740).
- Can be used horizontally, vertically or wall mounted.
- Spring loaded end frame designed for easy loading of 3M™ Overspray Protective Sheeting.
- **NOTE: PAPER IS NOT INCLUDED WITH MASKER.**

Part Number	Quantity Per Case
051131-06780	1

Scotch® Cart Masker 18"



- Dispenses one roll of masking paper up to 18" wide on each of the two levels.
- With the purchase of Scotch® Conversion Kit (PN06782), it becomes a three-roll capacity masker.
- Has large, deep storage trays on the top and bottom.
- The narrow width, large handle, and 8" wheels make moving it very easy.
- Has a built-in storage rack for spray guns, and two hooks for masking tape.
- Very easy to assemble.
- **NOTE: PAPER IS NOT INCLUDED WITH MASKER.**

Part Number	Each Per Case
051131-06781	1

Scotch® Conversion Kit

The kit includes:

- One Paper roll double hub bracket assembly.
- Two Paper roll bracket assemblies.
- One Spring brake.
- One Tape drum for converting Scotch® Maskers (PNs 06781, 06783, and 06784).
- One Tape drum for converting Scotch® Tapers/Maskers (PNs 06865, 06866, and 06869).



Part Number	Each Per Case
051131-06782	1

Scotch® Tray Masker 18" or 36"



- Dispenses single rolls of masking paper.
- Built into the top is a handy large storage tray.
- Can be wall mounted.
- Very easy to assemble.
- With the purchase of Scotch® Conversion Kit (PN06782), it becomes a two-roll masker.
- Available in either an 18" or 36".
- **NOTE: PAPER IS NOT INCLUDED WITH MASKER.**

Part Number	Maximum Width of Masking Paper	Each Per Case
051131-06783	36"	1
051131-06784	18"	1

Scotch® Utility Masker 12"

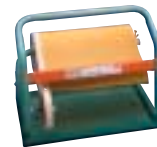

- Provides the means for dispensing masking paper up to 12" wide.
- Incorporates a large handy storage tray.
- **NOTE: PAPER IS NOT INCLUDED WITH MASKER.**

Part Number	Each Per Case
021200-06810	1

Scotch® Handy Masker 12"



- Step-stool top for reaching vehicle roofs.
- Dispenses 3", 6", 9" or 12" masking paper.
- **NOTE: PAPER IS NOT INCLUDED WITH MASKER.**

Part Number	Each Per Case
021200-06814	1

Scotch® Slimline Apron Taper 18"



- Dispenses three rolls of masking paper up to 18" wide.
- Can be easily moved from job to job with one hand mobility.
- Maintains proper tape and paper alignment.
- Doesn't require adjusting.
- **NOTE: PAPER IS NOT INCLUDED WITH MASKER.**

Part Number	Each Per Case
021200-06864	1

Masking Equipment

Scotch® Apron Taper 18"

- Masking jobs are faster and easier.
- Dispenses masking paper up to 18" wide.
- Adapts for any combination of two paper widths up through 18" with Scotch® Conversion Kit (PN06782).
- **NOTE: PAPER IS NOT INCLUDED WITH MASKER.**



Part Number	Each Per Case
021200-06865	1

Scotch® Apron Taper 36"

- Dispenses masking paper up to 36" wide.
- Adapts for any combination of two paper widths up through 36" with Scotch® Conversion Kit (PN06782).
- **NOTE: PAPER IS NOT INCLUDED WITH MASKER.**



Part Number	Each Per Case
021200-06866	1

Scotch® Multi-Mobile Masker

- Reduces labor costs.
- Fast and convenient.
- Two-roll capacity with top and bottom dispensing system.
- Dispenses single aprons through 18" wide, laminates tape to paper as paper is dispensed.
- Comes easy to assemble — insert two bolts to complete frame and four bolts to mount lower cutter blade.
- With purchase of Scotch® Conversion Kit (PN06782), it becomes a three-roll capacity dispenser.
- **NOTE: PAPER IS NOT INCLUDED WITH MASKER.**



Part Number	Each Per Case
021200-06869	1

Scotch® Mobile Frame

- Designed to have the Scotch® Apron Taper (PN06866) added to the top.
- This frame is for those wishing to build a mobile 36" dispenser.
- Preassembled except for insertion of two bolts to make frame operative.



Part Number	Each Per Case
021200-06871	1

For 3M replacement masking machine parts, call 1-800-344-9883 or fax 715-268-8153.

Hand Masking

3M™ Hand-Masker™ Pre-Taped Plastic Drop Cloth PT2090

- A convenient, pre-taped plastic film which unfolds to cover and protect various surfaces while painting.
- Specially treated film clings to surfaces and is easy to cleanup.
- Pre-taped with Scotch-Blue™ Painter's Tape for Multi-Surfaces 2090, which is sunlight stable and gives the user seven-day clean removal.



Part Number	Size	Rolls Per Case
051131-06696	24" x 30 yds.	12

3M™ Hand-Masker™ Paper Blade

- Use in conjunction with all 3M™ Hand-Masker™ Dispensers.



Part Number	Size	Blades Per Case
051131-06794	6"	6
051131-06795	9"	6
051131-06796	12"	6
051131-06798	18"	6

3M™ Hand-Masker™ Film Blade

- Use in conjunction with all 3M™ Hand-Masker™ Dispensers.
- Use to cut 3M™ Hand-Masker™ Pre-Folded Masking Film (PNs 06845, 06846, 06848, 06849 and 06860).



Part Number	Size	Blades Per Case
051131-06802	12"	6
051131-06804	6"	6

3M™ Hand-Masker™ Tack Down Tape Dispenser

- Attachment for the 3M™ Hand-Masker™ Dispenser (PN06788).
- Accommodates an additional roll of masking tape for tacking down the loose end of masking paper during masking applications.
- **NOTE: PRODUCT IS NOT INCLUDED WITH DISPENSER.**



Part Number	Dispensers Per Case
051131-06787	6

Hand Masking

3M™ Hand-Masker™ Dispenser Kit M3000K

- Tape guide pin molded into the frame.
- Bayonet mount for the 3M™ Hand-Masker™ Tack Down Tape Dispenser (PN06787).
- Guide pin aids tracking of the masking tape onto masking paper while dispensing.
- 3M™ Hand-Masker™ Tack Down Tape Dispenser (PN06787) allows easy-on/easy-off mounting.
- Provides fingertip access to an extra roll of masking tape.
- Includes 12" cut-off blade.
- **NOTE: PRODUCT IS NOT INCLUDED WITH DISPENSER.**



Part Number	Dispensers Per Case
051131-06788	4

3M™ Hand-Masker™ Pre-Folded Masking Film

- High-density, non-porous film.
- Designed for paint masking and paint overspray protection.



Part Number	Size	Rolls Per Case
051131-06845	6" x 180' (folds down to 24")	12
051131-06846	9" x 90' (folds down to 72")	12
051131-06848	12" x 180' (folds down to 48")	12
051131-06849	12" x 90' (folds down to 99")	12
051131-06860	6" x 90' (folds down to 36")	12

Liquid Masking

3M™ Overspray Masking Liquid Dry

- Water-based masking liquid.
- Dries to a non-tacky film.
- Protects against paint and primer overspray.
- Traps dust and dirt under its protective film.
- Safe to use on all thoroughly cured paint surfaces.



Part Number	Container Size	Containers Per Case
051131-06847	1 Gallon	4
051131-06851	5 Gallon	1
051131-06856	15 Gallon	1
051131-06857	55 Gallon	1

3M™ Overspray Masking Liquid

- Specially designed sprayable liquid to provide overspray protection to vehicles.
- Remains tacky.
- Traps dust and dirt under its protective film and airborne dust and dirt on top of its protective film.



Part Number	Container Size	Containers Per Case
051131-06854	15 Gallon	1
051131-06855	55 Gallon	1

Safety



Products

Air-Supplied
Respirator Systems 127–131

Head, Eye and
Face Protection 133–136

Hearing Protection 124

3M™ Nomad™
Carpet Matting 137

Oil Spill and Fluid
Recovery Sorbents 132

Personal Care/
Comfort Products 124

Respirators and
Dust Masks . . .119–123, 125–126

Retail Safety Products 140

Safety Glasses 133–134

Safety Helmets 133

3M™ Safety-Walk™ Products
and Accessories 138–139

3M™ Speedglas™
Welding Lenses
and Accessories 134–136

3M™ Vanguard™ Lenses 140

Safety

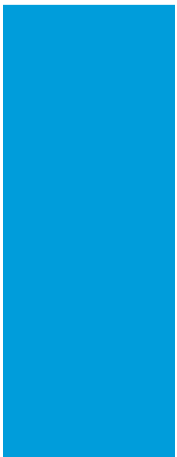

3M *Innovation*

Respirators

3M™ Particulate Respirator N95

- 3M recommended for use in applications where short duration protection from particulate exposures is needed.
- Disposable, lightweight.
- NIOSH 42 CFR 84 approved.
- Applications include scuffing, buffing and sweeping.



Part Number	Respirators Per Box	Boxes Per Case
051131-07027	30	4

3M™ Particulate Respirator N95

- New braided straps for increased comfort.
- NIOSH 42 CFR 84 approved.
- **3M recommended for grinding and sanding.**
- Lightweight completely disposable dust respirator.
- Easy to talk through.
- At least 95% filtration efficiency against solid and liquid aerosols that do not contain oil.



Part Number	Respirators Per Box	Boxes Per Case
051131-07048	20	8

3M™ Particulate Respirator N95

- NIOSH 42 CFR 84 approved.
- **3M recommended for grinding, sanding and buffing.**
- 3M™ Cool Flow™ exhalation valve improves comfort.
- “M” nose clip adjusts to many face shapes.
- Stapled straps improve durability.
- At least 95% filtration efficiency against solid and liquid aerosols that do not contain oil.



Part Number	Respirators Per Box	Boxes Per Case
051131-07185	10	8

3M™ Particulate Respirator N95

- Three-panel respirator.
- Increases worker comfort and convenience.
- Feels comfortable against skin.
- Resistance to collapse.
- Folded/individually packaged.
- NIOSH 42 CFR 84 approved.



Part Number	Respirators Per Box	Boxes Per Case
051131-37021	20	12

3M™ Particulate Respirator N95

- Three-panel respirator valved.
- Increased worker comfort and convenience.
- 3M™ Cool Flow™ Valve reduces breathing resistance.
- Feels comfortable against skin.
- Resistance to collapse.
- Folded/individually packaged.
- NIOSH 42 CFR 84 approved.



Part Number	Respirators Per Box	Boxes Per Case
051131-37022	10	12

3M™ Particulate Respirator R95

- NIOSH 42 CFR 84 approved.
- **3M recommended for undercoating and rustproofing.**
- Can also be used for grinding, sanding and buffing.
- 3M recommended for nuisance level organic vapor relief.**
- At least 95% filtration efficiency against solid and liquid aerosols that do not contain oil.



Part Number	Respirators Per Box	Boxes Per Case
051131-07186	20	6

3M™ Particulate Respirator N95

- NIOSH 42 CFR 84 approved.
- **3M recommended for welding applications.**
- 3M recommended protection for up to 10X OSHA PEL of ozone.
- Removes nuisance level organic vapors and odors.**
- 3M™ Cool Flow™ exhalation valve improves comfort.
- Adjustable straps and faceseal ring provide secure face fit.
- At least 95% filtration efficiency against solid and liquid aerosols that do not contain oil.



Part Number	Respirators Per Box	Boxes Per Case
051131-07187	10	8

3M™ Particulate Welding Respirator N95

- **3M recommended for welding applications.**
- 3M™ Cool Flow™ exhalation valve improves comfort.
- “M” noseclip adjusts for fewer pressure points and greater comfort.
- Black valve distinguishes the respirator.
- Braided headband provides comfort and durability.
- NIOSH 42 CFR 84 approved.



Part Number	Respirators Per Box	Boxes Per Case
051131-07189	10	8

NOTE: See Selection Guide on pages 125–126 for warnings and use limitations.

**Nuisance level organic vapor relief refers to reducing the irritating effects of concentrations not exceeding OSHA PEL or applicable government standard, whichever is lower.



WARNING:

Each respirator must be properly selected based on the contaminant and concentration levels to which the worker is exposed.

Failure to follow the use and fitting instructions and warnings for proper use contained on the respirator packaging and/or failure to wear the respirator during all times of exposure can reduce respirator effectiveness and may result in sickness or death. For proper use, see your supervisor. For more information, call 3M OH&ESD Technical Service at 1-800-243-4630. In Canada, call 1-800-267-4414.

Respirators

3M™ Bodyman Respirator Packout P100

- Facepiece respirators may be used up to 10X OSHA PEL or applicable government standard, whatever is lower. If exposure levels are not known, use a 3M Fresh Air system.
- NIOSH 42 CFR 84 approved.
- Reusable design — changeable filters.
- **3M recommended for grinding, sanding, welding and asbestos.**
- Activated carbon layer removes nuisance level organic vapors and odors.**
- At least 99.97% filtration efficiency against solid and liquid aerosols including oils.
- Packout includes: 1 facepiece and 4 (2-pack) P100 filters (PN07184).



Part Number	Description	Packouts Per Case
051131-07181	Small Packout	20
051131-07182	Medium Packout	20
051131-07183	Large Packout	20

Replacement Parts

Part Number	Description	Quantity Per Case
051131-07024	Small Facepiece	24
051131-07025	Medium Facepiece	24
051131-07026	Large Facepiece	24

Part Number	Description	Quantity Per Pack/Bag	Packs/Bags Per Case
051131-07184	P100 Filter	2	50
051131-07000	P100 Particulate Filter	2	50

3M™ Half Facepiece Respirator Assembly, P100

- 3M™ Half Facepiece Respirator Assembly, P100, is designed for use in applications such as brake and clutch repair where a technician requires a P100 level particulate filter for protection against asbestos fibers and other lining related dusts.
- Lightweight P100 disc type filters (PN07000) are designed to be easy to breathe through and are easily replaced because of their bayonet style attachment.
- **3M recommended for brake and clutch repair applications where asbestos may be present.**
- Assembly includes: 1 facepiece and 2 (2-pack) P100 filters (PN07000).
- NIOSH 42 CFR 84 approved.

Part Number	Description	Quantity Per Case
051131-07001	Small Assembly	24
051131-07002	Medium Assembly	24
051131-07003	Large Assembly	24

3M™ Disposable Organic Vapor Half Facepiece Respirator Assembly P95

- Half Facepiece respirators may be used up to 10X OSHA PEL or applicable government standard, whatever is lower. If exposure levels are not known, use a 3M Fresh Air system.
- NIOSH 42 CFR 84 approved.
- Maintenance free design.
- **3M recommended for paint spray applications.**
- At least 95% filtration efficiency against solid and liquid aerosols including oils.
- Assembly includes: 1 organic vapor respirator, 2 P95 filters and 2 filter retainers.



Part Number	Description	Assemblies Per Case
051131-07191	Small Assembly	12
051131-07192	Medium Assembly	12
051131-07193	Large Assembly	12

Replacement Parts

Part Number	Description	Quantity Per Box	Boxes Per Case
051131-07194	P95 Filter	10	10
051131-07054	Filter Retainer	20	5

NOTE: See Selection Guide on pages 125–126 for warnings and use limitations.

**Nuisance level organic vapor relief refers to reducing the irritating effects of concentrations not exceeding OSHA PEL or applicable government standard, whichever is lower.



WARNING:

Each respirator must be properly selected based on the contaminant and concentration levels to which the worker is exposed.

Failure to follow the use and fitting instructions and warnings for proper use contained on the respirator packaging and/or failure to wear the respirator during all times of exposure can reduce respirator effectiveness and **may result in sickness or death**. For proper use, see your supervisor. For more information, call 3M OH&ESD Technical Service at 1-800-243-4630. In Canada, call 1-800-267-4414.

Monitoring of exposure levels in applications such as paint spray must be done to determine cartridge change-out schedules.

Respirators

3M™ Organic Vapor/P95 Low-Maintenance Half Facepiece Respirator Packout



- Half Facepiece respirators may be used up to 10X OSHA PEL or applicable government standard, whatever is lower. If exposure levels are not known, use a 3M Fresh Air system.
- NIOSH 42 CFR 84 approved.
- **3M recommended for paint spray applications.**
- Reusable design on changeable filters and cartridges.
- At least 95% filtration efficiency against solid and liquid aerosols including oils.
- Packout includes: 1 reusable facepiece, 2 organic vapor cartridges, 4 P95 filters and 2 filter retainers.

Part Number	Description	Packouts Per Case
051131-07177	Small Packout	4
051131-07178	Medium Packout	4
051131-07179	Large Packout	4

Replacement Parts

Part Number	Description	Quantity Per Case
051131-07024	Small Facepiece	24
051131-07025	Medium Facepiece	24
051131-07026	Large Facepiece	24

Part Number	Description	Quantity Per Box	Boxes Per Case
051131-07046	Organic Vapor Cartridge	2	30
051131-07194	P95 Filter	10	10
051131-07195	Cartridge/Filter Packout	1	5
051131-07054	Cartridge/Filter Retainer	20	5

3M™ Automotive Professional Series Half Facepiece Paintspray Packout



- Designed for those respirator users who desire a maintainable respirator, the Professional Series from 3M is the latest innovation in comfort and durability for the automotive technician.
- Incorporates innovative design features to increase respirator comfort for the automotive technician.
- Made of a liquid silicone material, it is designed for use with replacement as necessary of cartridges, filters and spare parts.
- Lightweight with a swept-back cartridge design for unobstructed vision and excellent balance.
- Facepiece is also adaptable to the 3M Dual Airline Supplied Air “Fresh Air” systems.
- NIOSH 42 CFR 84 approved.

Part Number	Size	Packout Components	Quantity Per Case
051131-37077	Small	3M™ Automotive Professional Series Half Facepiece Respirator (37081), 1 pair organic vapor cartridges (07046), 1 pair retainers (07054), 2 pairs of P95 filters (07194)	4
051131-37078	Med.	3M™ Automotive Professional Series Half Facepiece Respirator (37082), 1 pair organic vapor cartridges (07046), 1 pair retainers (07054), 2 pairs of P95 filters (07194)	4
051131-37079	Large	3M™ Automotive Professional Series Half Facepiece Respirator (37083), 1 pair organic vapor cartridges (07046), 1 pair retainers (07054), 2 pairs of P95 filters (07194)	4

NOTE: See Selection Guide on pages 125–126 for warnings and use limitations.



⚠ WARNING:

Each respirator must be properly selected based on the contaminant and concentration levels to which the worker is exposed.

Failure to follow the use and fitting instructions and warnings for proper use contained on the respirator packaging and/or failure to wear the respirator during all times of exposure can reduce respirator effectiveness and **may result in sickness or death**. For proper use, see your supervisor. For more information, call 3M OH&ESD Technical Service at 1-800-243-4630. In Canada, call 1-800-267-4414.

Monitoring of exposure levels in applications such as paint spray must be done to determine cartridge change-out schedules.

Respirators

3M™ Automotive Professional Series Half Facepiece Respirator Rebuild Kit



- Designed for those respirator users who desire a facepiece that is fully maintainable and have a program in place to maintain respirators.
- Contains the following components necessary to maintain the 3M™ Automotive Professional Series Respirators (PNs 37077, 37078 and 37079):
 - 3M™ Head Harness Assembly 7581, 1 each
 - 3M™ Inhalation Valves 7582, 1 pair
 - 3M™ Exhalation Valve 7583, 1 each
 - 3M™ Cartridge Holder 7586, 1 each

Part Number	Quantity Per Case
051131-37080	5

3M™ Automotive Professional Series Half Facepiece Respirator



- Incorporates innovative design for worker comfort with durability for long life.
- Designed for use with 3M bayonet style cartridges and filters.

Part Number	Size	Quantity Per Case
051131-37081	Small	10
051131-37082	Medium	10
051131-37083	Large	10

Replacement Parts

Part Number	Description	Quantity Per Box	Boxes Per Case
051131-07046	Organic Vapor Cartridge	2	30
051131-07194	P95 Filter	10	10
051131-07195	Cartridge/Filter Packout	1	5
051131-07054	Cartridge/Filter Retainer	20	5

NOTE: See Selection Guide on pages 125–126 for warnings and use limitations.



WARNING:

Each respirator must be properly selected based on the contaminant and concentration levels to which the worker is exposed.

Failure to follow the use and fitting instructions and warnings for proper use contained on the respirator packaging and/or failure to wear the respirator during all times of exposure can reduce respirator effectiveness and **may result in sickness or death**. For proper use, see your supervisor. For more information, call 3M OH&ESD Technical Service at 1-800-243-4630. In Canada, call 1-800-267-4414.

Monitoring of exposure levels in applications such as paint spray must be done to determine cartridge change-out schedules.

3M™ Full Facepiece Respirator Organic Vapor/P95 Packout



- Full Facepiece respirators may be used up to 50X OSHA PEL or applicable government standard, whatever is lower. If exposure levels are not known, use a 3M Fresh Air system.
- Facepiece is also adaptable to the 3M Dual Airline Supplied Air “Fresh Air” Systems.
- NIOSH 42 CFR 84 approved.
- **3M recommended for paint spray applications.**
- Reusable design with replaceable filters and cartridges.
- Affords eye and respiratory protection.
- Face shield covers available to protect face shield.
- At least 95% filtration efficiency against solid and liquid aerosols including oils.
- Packout includes: 1 reusable facepiece, 2 organic vapor cartridges, 4 P95 filters, 2 filter retainers and 2 face shield covers.

Part Number	Description	Packouts Per Case
051131-07161	Small Packout	2
051131-07162	Medium Packout	2
051131-07163	Large Packout	2

3M™ Automotive Full Facepiece Respirators (Facepiece Only)

Part Number	Description	Quantity Per Case
051131-07138	Small Facepiece	1
051131-07139	Medium Facepiece	1
051131-07140	Large Facepiece	1

Replacement Parts

Part Number	Description	Quantity Per Pack	Packs Per Case
051131-07141	Spectacle Kit for Full Facepiece	1	1
051131-07142	Face Shield Covers	25	4
051131-07143	Exhalation Valve for Full Facepiece	10	1
051131-07144	Inhalation Valve for Full Facepiece	40	5
051131-07145	Inhalation Gaskets for Full Facepiece	20	4
051131-37003	Center Adapter Assembly	1	5
051131-37004	Nosecup Assembly	1	5
051131-37005	Head Harness Assembly	1	5
051131-37006	Lens Assembly	1	5
051131-37007	Frame Kit	1	5
051131-07046	Organic Vapor Cartridge	2	30
051131-07047	Organic Vapor/Acid Gas Cartridge	2	30
051131-07194	P95 Filter	10	10
051131-07054	Filter Retainer	20	5

Respirators

3M™ Organic Vapor Cartridge/ 95 Filter Replacement Packout

- Used to replace the cartridges and filters on the following respirators: 07024, 07025, 07026, 07138, 07139, 07140, 07161, 07162, 07163, 07177, 07178, 07179, 37077, 37078 and 37079.



Part Number	Quantity Per Case
051131-07195	5

3M™ Organic Vapor Monitor with Analysis

- Used to determine exposure levels of certain organic vapors.
- Pre-paid analysis allows the user to send the exposed monitor to a 3M Laboratory for analysis (instructions included in package).
- Exposure levels are calculated and a report is sent which will assist the user in determining what their exposure level is, allowing them to determine the most appropriate respiratory protection for the operation monitored.



Part Number	Quantity Per Case
051131-37023	1

3M™ Respirator Cleaning Wipe

- Individually wrapped towelettes.
- Alcohol free formula.
- Pleasant fragrance.
- Oversized 8-1/2" x 11" — ideal for cleaning full facepiece respirators.
- Convenient dispenser box.



Part Number	Wipes Per Box	Boxes Per Case
051131-07065	100	5

Respirator Compliance Software

3M™ Respirator Compliance Software — Windows® Based CD-ROM Required

- Developed to help customer comply with the OSHA requirements.
- Provides forms for employee and workplace records.
- Completely menu driven, no computer experience is needed.
- Provides audit trail.
- Alerts you to the need for training, fit testing, etc.
- Computer needs: Minimum 486 IBM PC or fully compatible with CD-ROM drives. VGA graphics or compatible adapter and 15 MB available on hard drive for each program.
- Operating System: Windows® 3.1, Windows® 95, Windows® NT, or Windows® or Workgroups.
- Memory: 16 MB RAM memory and a minimum of an additional 16MB virtual memory.



Part Number	Description	Quantity Per Case
051131-07160	Respirator Compliance Software	1

Windows® is a registered trademark of Microsoft Corporation.

Personal Care/Comfort Products

3M™ Paint Buster™ Hand Cleaner



- A cream-type hand cleaner.
- Offers superior performance in the removal of lacquer, enamel and urethane paints, primers, putties, plastic fillers, adhesives and automotive sealants from skin.

Part Number	Size	Tubes Per Case
051131-05975	10.5 fl. oz. Tube	12

3M™ Nexcare™ Active™ Strips Flexible Foam Bandages



- Feature an advanced moisture-resistant adhesive that provides extra sticking power on damp or sweaty skin.
- Bandage stays put during work and resists coming off when immersed in water.
- Made of a unique, flexible foam that stretches, flexes and conforms, unlike many conventional plastic bandages that can curl up, fall off, or chaff the skin.
- The adhesive strip forms a frame around the pad to help seal out dirt and contaminants.

Part Number	UPC Number	Size	Qty./Box	Boxes/Case
516-45	051131-62030	Assorted Pack 10-7/8" x 3" Strips 10-5/8" x 3" Strips 10-7/8" Spots 15-3/8" x 1-1/2" Strips	45	24
17021	051131-62040	1" x 3" Strip	100	12
17020	051131-62041	3/4" x 3" Strip	100	12

Hearing Protection*

3M™ Ear Muffs

- Safety orange in color.
- Has a forked adjustable headband for fit and comfort.
- Molded noise suppression inserts and ear cushions are replaceable.
- Noise Reduction Rating (NRR) of 23dB when properly worn.



Part Number	Pairs Per Case
051131-07063	20

3M™ Foam Ear Plugs

- Use to protect hearing from loud and constant noises generated by grinding, sanding, buffing, or engine work.
- Provides comfortable and effective noise reduction (Noise Reduction Rating (NRR) is 28dB) with the convenience of disposability.
- Hypo-allergenic material.
- Available as individual ear plugs (PN37062) or with a soft, braided cord attached (PN37063) that provides accessibility and helps prevent loss.

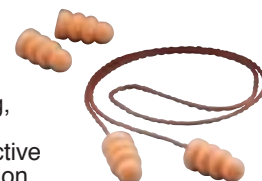

Part Number	Description	Pairs Per Box	Boxes Per Case
051131-37062	Ear Plug	200	5
051131-37063	Corded Ear Plug	100	5

*NOTE: Research suggests that the NRR may overestimate the protection provided by hearing protectors during typical use. 3M recommends reducing the NRR by 50% for estimating the amount of noise reduction provided.

⚠ WARNING: Hearing Protection Products

These hearing protection products help prevent hearing loss against certain noises. To provide proper protection, the hearing protector should be (1) suitable for the job, (2) fitted properly in/on the ear, (3) worn at all times of exposure to noise, and (4) replaced when damaged or otherwise necessary. Failure to fit and use hearing protectors according to these instructions will reduce their effectiveness. Failure to wear hearing protectors 100% of the time that you are exposed to hazardous noise may dramatically increase your risk of developing hearing loss. Keep ear plugs away from infants and small children. They may get caught in a child's windpipe.

3M Automotive Respirators

Selection Guide for Filtering Facepiece Disposable Respirators

Respirator Part No.	Typical Applications	Warning	Use Limitations
07048 07185 37021 37022	<ul style="list-style-type: none"> • Grinding • Sanding • N95 	<p>These respirators help protect against certain dusts and mists. Misuse may result in sickness or death. For proper use, see supervisor or respirator package or call 1-800-243-4630.</p>	<ol style="list-style-type: none"> 1. Do not use for protection against gases, vapors or asbestos, or in sandblasting, or paint spray operations, or in atmospheres containing less than 19.5% oxygen. 2. Do not use when concentrations of contaminants are immediately dangerous to life and health or are unknown. 3. Do not use when concentrations exceed 10 times the permissible exposure limit or the maximum use concentration in applicable OSHA standards, whichever is lower. 4. Do not abuse or misuse this respirator. 5. Do not use with beards or other facial hair that prevents direct contact between the face and the edge of the respirator.



07048



07185



37021



37022

07186	<ul style="list-style-type: none"> • Undercoating • Rustproofing • R95 	<p>This respirator helps protect against certain dusts and mists. Misuse may result in sickness or death. For proper use, see supervisor or respirator package or call 1-800-243-4630.</p>	<p>See above.</p>
--------------	---	--	-------------------



3M recommended for relief against nuisance levels of organic vapors.*

07187	<ul style="list-style-type: none"> • Stainless Welding • Galvanized Welding • N95 	<p>These respirators help protect against certain dusts, fumes and mists. Misuse may result in sickness or death. For proper use, see supervisor or respirator package or call 1-800-243-4630.</p>	<p>See above.</p>
--------------	--	--	-------------------



07187



07189

07189	<ul style="list-style-type: none"> • Welding Metal • Grinding • Brazing 		
--------------	--	--	--

3M recommended for welding on stainless steel, aluminum, galvanized steel and other applications where ozone and nuisance level organic vapors may be present.*

07027	<ul style="list-style-type: none"> • Scuffing • Buffing • Sweeping 	<p>This respirator helps protect against certain dusts and mists. Misuse may result in sickness or death. For proper use, see supervisor or respirator package or call 1-800-243-4630.</p>	<p>See above.</p>
--------------	---	--	-------------------



* Nuisance level organic vapor relief refers to reducing the irritating effects of concentrations not exceeding OSHA PEL or applicable government standard, whichever is lower.

3M Automotive Respirators

Selection Guide for Dual Cartridge Respirators

Respirator Part No.	Typical Applications	Warning	Use Limitations
07181 07182 07183	<ul style="list-style-type: none"> • Welding • Grinding • Undercoating • Sanding • P100 Filters 	<p>These respirators help protect against certain dusts, fumes, mists, radionuclides and asbestos containing dusts and mists. Misuse may result in sickness or death. For proper use, see supervisor or respirator package or call 1-800-243-4630.</p>	<ol style="list-style-type: none"> 1. Do not use for protection against gases, vapors, sandblasting or paint spray operations. 2. This respirator does not supply oxygen. Do not use in atmosphere containing less than 19.5% oxygen. 3. Do not use when concentrations of contaminants are immediately dangerous to life and health or are unknown. Do not use when concentrations exceed 10 times the permissible exposure limit, the maximum use concentration of the cartridge, or the maximum use concentrations in applicable OSHA standards, whichever is lower 4. Do not abuse or misuse this respirator. 5. Do not use with beards or other facial hair that prevents direct contact between the face and the edge of the respirator.



3M recommended for relief against nuisance levels of organic vapors.*

07001 07002 07003	<ul style="list-style-type: none"> • Clutch Repair • Brake Repair 	<p>See above.</p>	 <p>See above.</p>
--	---	-------------------	---

DISPOSABLE

07191 07192 07193	<ul style="list-style-type: none"> • Paint Spraying • OV/P95 	<p>These respirators help protect against certain dusts, mists, gases or vapors. Misuse may result in sickness or death. For proper use, see supervisor or respirator package or call 1-800-243-4630.</p>	<ol style="list-style-type: none"> 1. These respirators do not supply oxygen. Do not use in an atmosphere containing less than 19.5% oxygen. 2. Do not use when concentrations of contaminants are immediately dangerous to life and health or are unknown. Do not use when concentrations exceed 10 times the permissible exposure limit, the maximum use concentration of the cartridge, or the maximum use concentrations in applicable OSHA standards, whichever is lower.
--	--	---	--



LOW MAINTENANCE

07177 07178 07179	<ul style="list-style-type: none"> • Paint Spraying • OV/P95 • Can be adapted for positive-pressure use 		<ol style="list-style-type: none"> 3. Prefilters are required for use against certain dusts and mists. For specific applications, consult an industrial hygienist or call 3M at 1-800-243-4630. 4. Do not abuse or misuse this respirator.
--	--	--	--



PROFESSIONAL SERIES

37077 37078 37079	<ul style="list-style-type: none"> • Paint Spraying • OV/P95 • Can be adapted for positive-pressure use 		<ol style="list-style-type: none"> 5. Do not use with beards or other facial hair that prevents direct contact between the face and the edge of the respirator.
--	--	--	--

FULL FACEPIECE

07161 07162 07163	<ul style="list-style-type: none"> • Paint Spraying • Helps provide eye protection • OV/P95 • Can be adapted for positive-pressure use 	<p>These respirators help protect against certain dusts, mists, gases or vapors. Misuse may result in sickness or death. For proper use, see supervisor or respirator package or call 1-800-243-4630.</p>	<p>See above.</p>
--	--	---	-------------------



* Nuisance level organic vapor relief refers to reducing the irritating effects of concentrations not exceeding OSHA PEL or applicable government standard, whichever is lower.

Fresh Air Respirators — PAPR (Powered Air Purifying Respirator)

3M™ GVP PAPR Kit 07190

- Kit includes all of the components that make up our PAPR with Bumpcap system with one easy-to-order part number. It includes the following which make a complete PAPR (Powered Air Purifying Respirator) system:
 - 1 Bumpcap with Wide View Face Shield 37008
 - 1 Breathing Tube 37012
 - 1 Comfort Belt-Mounted PAPR Assembly
 - Motor Blower GVP-100 (PN29206)
 - Battery GVP-111 (PN29208)
 - Charger GVP-112 (PN29209)
 - Flow Meter GVP-113 (PN29210)
 - Power Cord GVP-110 (PN29207)
 - Blower Plugs GVP-115 (PN29212)
 - Flow Meter Adapter L-181 (PN72792)
 - Comfort Belt 37054
 - 1 Organic Vapor/HEPA Cartridge GVP-441 (PN07196)
 - 1 Shower Cover GVP-119 (PN54304)
 - 5 Peel-Off Lens Covers
 - Replacement 37014, 25 Pack
 - Replacement 37015, 100 Pack
- 3M™ GVP PAPR Kit 07190 combines a high level of protection for automotive technicians with exceptional performance and versatility.
- Added features/benefits of the 07190 kit include:
 - No additional hoses to carry
 - Mobility
 - Wide-view lens headgear options with liftable lens
 - 8-hour intrinsically safe battery
 - Excellent airflow
 - Multiple filter/cartridge options
 - One size fits most technicians
- Applications include painting, sanding and grinding.



Part Number	Quantity Per Case
051131-07190	1

3M™ Organic Vapor/High Efficiency Cartridge

- Used with 3M™ Belt Mounted PAPR (PN07190).
- Attaches to the motor blower unit.
- Filters the supplied air to the headgear.



Part Number	Quantity Per Case
051131-07196	6



⚠ WARNING:

These respirators help reduce exposure to certain airborne contaminants. Misuse may result in sickness or death. For proper use, see package, supervisor or call 3M Technical Service at 1-800-243-4630.

3M positive pressure respirators are to be used only by qualified persons properly trained in their use and maintenance, and only in accordance with their operating and maintenance manuals. Each person using these products must first read and understand the User Instructions. These products do not provide primary eye and face impact protection.

Monitoring of exposure levels in applications such as paint spray must be done to determine cartridge change-out schedules.

Fresh Air Respirators — L-Series

3M™ L-Series Bump Cap Headgear with Wide View Face Shield

- Lightweight, well balanced, excellent visibility, liftable lens.
- Applications: Painting, grinding, sanding.
- L-Series Bump Caps feature a wide view lens providing excellent vision.
- Positive airflow provides respiratory protection without the need for a tight faceseal.
- Can be worn with glasses and other safety equipment.
- Can be used with 3M Powered Air (PAPR) or Supplied Air Systems.
- Requires at least 6 CFM at pressure range noted on air regulator or adapter.



Part Number	Description	Quantity Per Case
051131- 37008	Bump Cap with Wide View Face Shield	1

Breathing Tube

051131- 37012	Breathing Tube	1
----------------------	----------------	---

Air Control Devices

051131- 37018	Vortex Cooling Assembly	1
----------------------	-------------------------	---

051131- 37019	Air Regulating Valve Assembly	1
----------------------	-------------------------------	---

051131- 37020	Low Pressure Connector Assembly	1
----------------------	---------------------------------	---

25-80 psi Supply Pressures

051131- 07010	Compressed Air Hose 25'-3/8" ID	1
----------------------	---------------------------------	---

051131- 07011	Compressed Air Hose 50'-3/8" ID	1
----------------------	---------------------------------	---

051131- 07012	Compressed Air Hose 100'-3/8" ID	1
----------------------	----------------------------------	---

4-15 psi Supply Pressures

051131- 07033	Low Pressure Hose 25'-1/2" ID	1
----------------------	-------------------------------	---

051131- 07034	Low Pressure Hose 50'-1/2" ID	1
----------------------	-------------------------------	---

051131- 07035	Low Pressure Hose 100'-1/2" ID	1
----------------------	--------------------------------	---

Replacement Parts

051131- 37009	Head Suspension	2
----------------------	-----------------	---

051131- 37010	Sweat Pad	10
----------------------	-----------	----

051131- 37011	Faceseal (made of Tyvek™ QC Fabric)	5
----------------------	-------------------------------------	---

051131- 37013	Wide View Lens	10
----------------------	----------------	----

051131- 37014	Lens Cover 25/Pack	1
----------------------	--------------------	---

051131- 37015	Lens Cover 100/Pack	1
----------------------	---------------------	---

051131- 37016	Knob and Pivot Kit	1
----------------------	--------------------	---

051131- 37017	Head Gear Cover	1
----------------------	-----------------	---

3M™ Carbon Monoxide (CO) Monitor with Retrofit Kit

- Stand alone airline Carbon Monoxide (CO) monitoring system.
- Allows for the addition of a CO monitor to existing systems as well as serving as a component in new installations.
- OSHA 1910.134 requires respirator airline CO monitoring.
- CO specific to eliminate "false alarms."
- Intrinsically safe when used with a 9 volt battery.
- Designed to connect directly to the 3M Air Filter and Regulator Panel (PN07006) or directly into supplied air piping.
- Easy to calibrate.



Part Number	Quantity Per Case
051131- 37027	1

Replacement Parts and Accessories

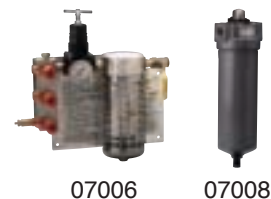

Part Number	Description	Quantity Per Case
051131- 07006	High Pressure Compressed Air Filter and Regulator Panel	1
051131- 07007	Panel Replacement Filter	10
051131- 07008	Coalescing Filter Assembly	1
051131- 07009	Replacement Filter for 3M™ Filter Assembly (PN07008)	4



⚠ WARNING:

Each respirator must be properly selected based on the contaminant and concentration levels to which the worker is exposed.

Failure to follow the use and fitting instructions and warnings for proper use contained on the respirator packaging and/or failure to wear the respirator during all times of exposure can reduce respirator effectiveness and **may result in sickness or death**. For proper use, see your supervisor. For more information, call 3M OH&ESD Technical Service at 1-800-243-4630. In Canada, call 1-800-267-4414.

Fresh Air Respirators — H-Series

3M™ H-Series Respirators

- Designed for use with an approved supplied air pump or compressor. (3M does not provide supplied air pumps and compressors.)
- NIOSH/MSHA approved as a Type C continuous flow supplied air respirator.
- 3M recommended for paints containing isocyanates (e.i., two-parts urethane paints).
- **3M™ H-Series Hardhat Hood Assembly (PN07030) includes:**
 - One 3M™ Plastic Squeeze Clamp (PN07036)
 - Two 3M™ H-Series Hoods (PN07037)
 - One 3M™ Cup Suspension (PN07038)
 - Two 3M™ Film Covers (PN07042)
- **3M™ H-Series Assembly (PN07044) includes:**
 - One 3M™ Head Suspension (PN07041)
 - One 3M™ Plastic Squeeze Clamp (PN07036)
 - Two 3M™ H-Series Hoods (PN07037)
 - One 3M™ H-Series Hardhat (PN07039)
 - Two 3M™ Film Covers (PN07042)
- Requires at least 6 CFM at pressure range noted on air regulator or adapter.

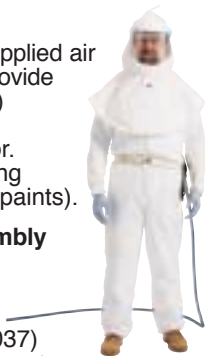

High Pressure System

Part Number	Description	Quantity Per Case
25-80 psi Supply Pressures		
051131-07010	Compressed Air Hose 25'-3/8" ID	1
051131-07011	Compressed Air Hose 50'-3/8" ID	1
051131-07012	Compressed Air Hose 100'-3/8" ID	1
051131-07028	Vortex Air Cooling Assembly	1
051131-07029	Air Regulator Assembly	1
051131-07030	H-Series Hood Assembly	1
051131-07031	Breathing Tube	1
051131-07044	H-Series Assembly w/Hardhat	1

Low Pressure System

Part Number	Description	Quantity Per Case
4-15 psi Supply Pressures		
051131-07030	H-Series Hood Assembly	1
051131-07031	Breathing Tube	1
051131-07032	Low Pressure Adapter Assembly	1
051131-07033	Low Pressure Hose 25'-1/2" ID	1
051131-07034	Low Pressure Hose 50'-1/2" ID	1
051131-07035	Low Pressure Hose 100'-1/2" ID	1
051131-07044	H-Series Assembly	1

Please note that either 3M™ (PN07030 or PN07044) H-Series Assembly plus Breathing Tube (PN07031), Vortex Air Cooling Assembly (PN07028) (if High Pressure System), Low Pressure Adapter Assembly (PN07032) (if Low Pressure System) and appropriate high or low pressure Air Hose must be ordered to make a complete 3M™ H-Series Positive Pressure Respirator.

3M™ H-Series Fresh Air Supplied Air Respirator

Replacement Parts and Accessories

Part Number	Description	Each Per Pack	Packs/ Qty. Per Case
051131-07036	Plastic Squeeze Clamp	2	1
051131-07037	H-Series Shroud	—	10
051131-07038	Cap Suspension	—	1
051131-07039	Hatshell	—	5
051131-07042	Face Shield Cover 5-1/2" x 10-1/2"	10	1
051131-07043	Face Shield Cover 5-1/2" x 10-1/2"	100	1
051131-07045	Waist Belt	—	1



⚠ WARNING:

Each respirator must be properly selected based on the contaminant and concentration levels to which the worker is exposed.

Failure to follow the use and fitting instructions and warnings for proper use contained on the respirator packaging and/or failure to wear the respirator during all times of exposure can reduce respirator effectiveness and **may result in sickness or death**. For proper use, see your supervisor. For more information, call 3M OH&ESD Technical Service at 1-800-243-4630. In Canada, call 1-800-267-4414.

Fresh Air Respirators — Dual Airline Supplied Air

3M™ Dual Airline Supplied Air Respirators

(The employer must supply all airline respirator systems with grade D breathing air within specific pressure ranges and volumes.)

- NIOSH approved and ideal for spray painting and welding.
- Easy to assemble, simple to use.
- Dual airlines deliver air to both sides of the facepiece.
- Symmetrical designs provide balance — won't pull to one side.
- Uses 3M™ Half Facepiece Respirators (PN07024 — small, PN07025 — medium, PN07026 — large) or Full Facepieces (PN07138 — small, PN07139 — medium, PN07140 — large).
- Available with front- or back-mounted dual airline breathing tubes.
- Available in high or low pressure configurations.
- Can be ordered as complete kits or as component parts.

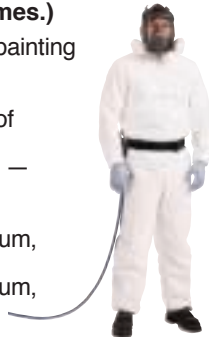

3M™ Half and Full Facepiece High Pressure Dual Airline Respirator Kits

- Kit includes one each:
 - Half Facepiece (Medium PN07025 or Large PN07026) or Full Facepiece (Medium PN07139 or Large PN07140)
 - Backmount Breathing Tube (PN07148)
 - Air Regulator (PN07149)
 - Web Belt (PN07152)
 - 50' Compressed Air Hose (PN07011)
- Requires at least 4 CFM at 17–26 psi of grade D breathing air.

Part Number	Size	Kits Per Case
Half Facepiece		
051131-07134	Medium Half Facepiece	1
051131-07135	Large Half Facepiece	1
Full Facepiece		
051131-07136	Medium Full Facepiece	1
051131-07137	Large Full Facepiece	1

3M™ Half and Full Facepiece Low Pressure Dual Airline Respirator Kits

- Kit includes one each:
 - Half Facepiece (Medium PN07025 or Large PN07026) or Full Facepiece (Medium PN07139 or Large PN07140)
 - Backmount Breathing Tube (PN07148)
 - Low Pressure Connector (PN07150)
 - Web Belt (PN07152)
 - 50' Low Pressure Hose (PN07034)
- Requires at least 4 CFM at 9–16 psi of grade D breathing air.

Part Number	Size	Kits Per Case
Half Facepiece		
051131-07130	Medium Half Facepiece	1
051131-07131	Large Half Facepiece	1
Full Facepiece		
051131-07132	Medium Full Facepiece	1
051131-07133	Large Full Facepiece	1

3M™ Half and Full Facepiece Low Pressure Combination Dual Airline Respirator Kits

- Kit includes:
 - Half Facepiece (Medium PN07025 or Large PN07026) or Full Facepiece (Medium PN07139 or Large PN07140)
 - One Back-Mounted Combination Dual Airline Breathing Tube (PN37001)
 - One Connector Assembly (PN07154)
 - One 50' Low Pressure Hose (PN07034)
 - One Pair Organic Vapor Cartridges (PN07046)
 - One Pair Filter Retainers (PN07054)
 - Two Pair P95 Filters (PN07194)
- Requires at least 4 CFM at 9–16 psi of grade D breathing air.

Part Number	Size	Kits Per Case
Half Facepiece		
051131-37030	Medium Half Facepiece	1
051131-37031	Large Half Facepiece	1
Full Facepiece		
051131-37032	Medium Full Facepiece	1
051131-37033	Large Full Facepiece	1



WARNING:

Each respirator must be properly selected based on the contaminant and concentration levels to which the worker is exposed.

Failure to follow the use and fitting instructions and warnings for proper use contained on the respirator packaging and/or failure to wear the respirator during all times of exposure can reduce respirator effectiveness and **may result in sickness or death**. For proper use, see your supervisor. For more information, call 3M OH&ESD Technical Service at 1-800-243-4630. In Canada, call 1-800-267-4414.

Fresh Air Respirators — Dual Airline Supplied Air

3M™ Half or Full Facepiece High Pressure Combination Dual Airline Respirator Kits

- Kit includes:
 - Half Facepiece (Medium PN07025 or Large PN07026) or Full Facepiece (Medium PN07139 or Large PN07140)
 - One Back-Mounted Combination Dual Airline Breathing Tube (PN37001)
 - One Air Regulator Assembly (PN07153)
 - One 50' High Pressure Hose (PN07011)
 - One Pair Organic Vapor Cartridges (PN07046)
 - One Pair Filter Retainers (PN07054)
 - Two Pair P95 Filters (PN07194)
- Requires at least 4 CFM at 17–26 psi of grade D breathing air.

Part Number	Size	Kits Per Case
Half Facepiece		
051131- 37034	Medium Half Facepiece	1
051131- 37035	Large Half Facepiece	1
Full Facepiece		
051131- 37036	Medium Full Facepiece	1
051131- 37037	Large Full Facepiece	1

Replacement Parts and Accessories

Part Number	Description	Quantity Per Case
051131- 07010	25' Airline Hose - 3/8" I.D.	1
051131- 07011	50' Airline Hose - 3/8" I.D.	1
051131- 07012	100' Airline Hose - 3/8" I.D.	1
051131- 07024	Small Half Facepiece Respirator	24
051131- 07025	Medium Half Facepiece Respirator	24
051131- 07026	Large Half Facepiece Respirator	24
051131- 07033	Low Pressure Hose 25'-1/2" I.D.	1
051131- 07034	Low Pressure Hose 50'-1/2" I.D.	1
051131- 07035	Low Pressure Hose 100'-1/2" I.D.	1
051131- 07138	Small Full Facepiece	1
051131- 07139	Medium Full Facepiece	1
051131- 07140	Large Full Facepiece	1
051131- 07141	Spectacle Kit for Full Facepiece	1
051131- 07147	Frontmount Breathing Tube for Half Facepiece or Full Facepiece	1
051131- 07148	Backmount Breathing Tube for Half Facepiece or Full Facepiece	1
051131- 07149	Air Regulator only used with 3M™ 07147, 07148 or 37001 Breathing Tubes and 3M™ 07033, 07034 or 07035 Air Hoses	1
051131- 07150	Low Pressure Connector only used with 3M™ 07147, 07148 or 37001 Breathing Tubes and 3M™ 07033, 07034 or 07035 Air Hoses	1
051131- 07152	Web Belt used with 3M™ 07147 Air Regulator and 3M™ 07150 Low Pressure Connector	1

Replacement Parts and Accessories (continued)

Part Number	Description	Quantity Per Case
051131- 07153	Air Regulator Assembly includes 3M™ 07149 Air Regulator and 3M™ 07152 Web Belt	1
051131- 07154	Low Pressure Connector Assembly includes 3M™ 07150 Connector and 3M™ 07153 replacement parts and accessories	1
051131- 37001	Combination backmounted breathing tube for Half Facepiece or Full Facepieces. Can be used with appropriate cartridges and/or filters.	1
051131- 37002	Bayonet caps cover cartridge/ filter openings in combination backmounted breathing tube when cartridges/filters are not in use.	10

Part Number	Description	Each Per Bag	Bags Per Case
051131- 07142	Face Shield Covers for Full Facepiece	25	4
051131- 07143	Exhalation Valve for Full Facepiece	10	1
051131- 07144	Inhalation Valve for Full Facepiece	40	5
051131- 07145	Inhalation Gaskets for Full Facepiece	20	4

Part Number	Description	Each Per Pack	Packs Per Case
051131- 07155	Hansen Male Plug 3/8" FPT for 3M™ Low Pressure Hose 07033, 07034 or 07035	2	1
051131- 07156	Schrader Male Plug 3/8" FPT for 3M™ Low Pressure Hose 07033, 07034 or 07035	2	1
051131- 07157	Schrader Female Socket 3/8" FPT for 3M™ Low Pressure Hose 07033, 07034 or 07035	2	1
051131- 07158	Hansen Female Socket 3/8" FPT for 3M™ Low Pressure Hose 07033, 07034 or 07035	2	1



WARNING:

Each respirator must be properly selected based on the contaminant and concentration levels to which the worker is exposed.

Failure to follow the use and fitting instructions and warnings for proper use contained on the respirator packaging and/or failure to wear the respirator during all times of exposure can reduce respirator effectiveness and **may result in sickness or death**. For proper use, see your supervisor. For more information, call 3M OH&ESD Technical Service at 1-800-243-4630. In Canada, call 1-800-267-4414.

Oil Spill and Fluid Recovery Sorbents

3M™ Maintenance Sorbents

- Specially treated to absorb most shop liquids including motor oils, transmission fluids, gear oils and anti-freeze solutions.
- Packaged in gray pads, rolls and booms.
- Reduces overall costs of liquid cleanup and disposal.

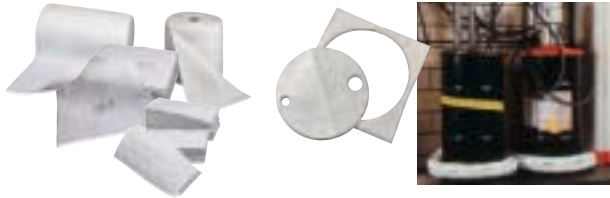

Part Number	Description	Quantity Per Box	Boxes Per Case
051131-07164	Pad 15-1/2" x 20-1/2"	100	1
051131-07165	Pad 7-1/2" x 20-1/2"	100	1
051131-07166	Roll 15-1/2" x 150'	1	1
051131-07167	Roll 38" x 150'	1	1
051131-07168	Boom 3" x 8'	6	1
051131-07169	22" Diameter Drum Cover	25	1

3M™ Folded Sorbents

- Four sorbents in one; boom, pillow, pad or roll.
- Handy dispenser box for easy, on-site use.
- Perforations every 16 inches allows you to select required length.
- 3M's high-volume sorbent technology.



Part Number	Color	Description	Boxes Per Case
051131-07172	Gray	Maintenance Sorbent Folded — 5" x 50'	3
051131-07173	White	Petroleum Sorbent Folded — 5" x 50' (Repels water)	3

3M™ Automotive Chemical Folded Sorbent Spill Kit

- Contents: Chemical Folded Sorbent, 1 temporary disposal bag and 1 tie.
- Versatile — can be used as booms, pillows, pads or rolls.
- Can be used for containing and absorbing most hazardous chemical spills of up to 5 gallons.
- Ideal for hazardous material response applications.

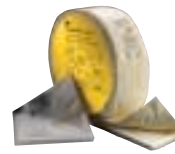

Part Number	Size	Rolls Per Case
051131-07175	5" x 26' with perforations every 16" Pad is 19" x 16" fully opened Roll is 19" x 26' fully opened	3

Head, Eye and Face Protection

3M™ Bump Cap



Part Number	Name/ Description	Packaging Quantity
051131-37100	3M™ Bump Cap	6/case

3M™ Safety Goggles and Visitor Specs



Visitor Specs Safety Goggles

Part Number	Name/ Description	Packaging Quantity
051131-37101	3M™ Visitor Specs Clear	12/box 25 boxes/case
051131-37102	3M™ Safety Goggles Perforated	24/box 12 boxes/case

3M™ Boas™ Protective Eyewear

- Feature polycarbonate lenses with 99% UV protection.
- Lightweight, designed for worker acceptance.



Part Number	Name/ Description	Packaging Quantity
051131-37103	3M™ Boas™ black frame, clear lens	24/case

3M™ Sting-Rays™ Protective Eyewear

- Feature lightweight, contemporary-styled frames that offer side and brow protection.
- Lens is made of durable, hard coated polycarbonate.



Part Number	Name/ Description	Packaging Quantity
051131-37104	3M™ Sting-Rays™ black frame, clear lens	24/case

3M™ Vipers™ Protective Eyewear

- Meets the requirements of ANSI Z87.1-1989, the standard for Occupational and Educational Eye and Face Protection.
- Stylish, one-piece wraparound design for good looks and optimal protection.
- Polycarbonate lens, 4-position temple adjustment and a vinyl nose pad for greater comfort.



Part Number	Name/ Description	Packaging Quantity
051131-37105	3M™ Vipers™ black frame, clear lens	24/case
051131-37108	3M™ Vipers™ black frame, amber lens	24/case

3M™ Lazers™ Protective Eyewear

- Meets the requirements of ANSI Z87.1-1989, the standard for Occupational and Educational Eye and Face Protection.
- Fashionable good looks.
- Comfortable, secure fit with wraparound design.
- Lightweight, contemporary-styled frames that offer side and brow protection.
- Lens is made of durable, hard-coated polycarbonate.



Part Number	Name/ Description	Packaging Quantity
051131-37109	3M™ Lazers™ black frame, amber lens	24/case

⚠ WARNING: Protective Eyewear Products

3M™ Protective Eyewear Products help provide limited eye and face protection against flying particles. **Misuse or failure to follow warnings and instructions may result in serious personal injury, including blindness, or death.** For proper use, see supervisor, read instructions and warnings on the package, or call 3M Occupational Health and Environmental Safety Division (OH&ESD) Technical Service in the U.S.A. at 1-800-243-4630. In Canada, call 1-800-267-4414.

Head, Eye and Face Protection

3M™ Protective Eyewear

- Shatter resistant, polycarbonate lenses.
- Compliant with ANSI Z87.1-2003 for limited eye and face protection against flying particles.
- Gel-like nosepiece for exceptional comfort
- Anti-scratch coating for longer use.
- 99% UV protection for outdoor use.



Part Number	Name/Description	Quantity Per Case
051131-37113	3M™ Protective Eyewear gray frame, clear lens	24
051131-37114	3M™ Protective Eyewear gray frame, smoke lens	24
051131-37115	3M™ Protective Eyewear blue frame, mirrored lens	24
051131-37116	3M™ Protective Eyewear clear frame, clear lens	24

3M™ Face Shield Kit

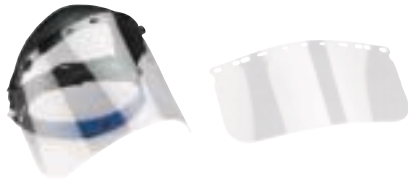

Face Shield Kit

Replacement Shield

Part Number	Name/Description	Packaging Quantity
051131-37106	3M™ Face Shield Kit	1/box 5 boxes/case
051131-37107	3M™ Replacement Shield	10/case

3M™ Speedglas™ Utility Lens and Helmet

- Most affordable auto-darkening lens.
- Lens shade is 10.
- Designed for MIG and stick welding only.



Part Number	Quantity Per Case
051131-37119	1

Replacement Parts and Accessories

Part Number	Description	Quantity Per Case
051131-37124	Replacement Sweatband for Headband, Plastic	1
051131-37126	Headcover Standard Beret	1
051131-37127	Throat Protector	1
051131-37129	Helmet Headband "S" Stop	10
051131-37131	Helmet Silver Front Panel	1
051131-37135	9000 X/XF Inside Protection Plate	5
051131-37136	9000 V/F Inside Protection Plate	5
051131-37137	9000 Batteries	2
051131-37140	9000 Headband with Mounting Hardware	1
051131-37141	9000 Mounting Hardware for Headband	1
051131-37148	3M™ Adflo™ Throat and Side Protector, Leather	1

3M™ Speedglas™ Replacement Parts and Accessories (Pages 134–136)

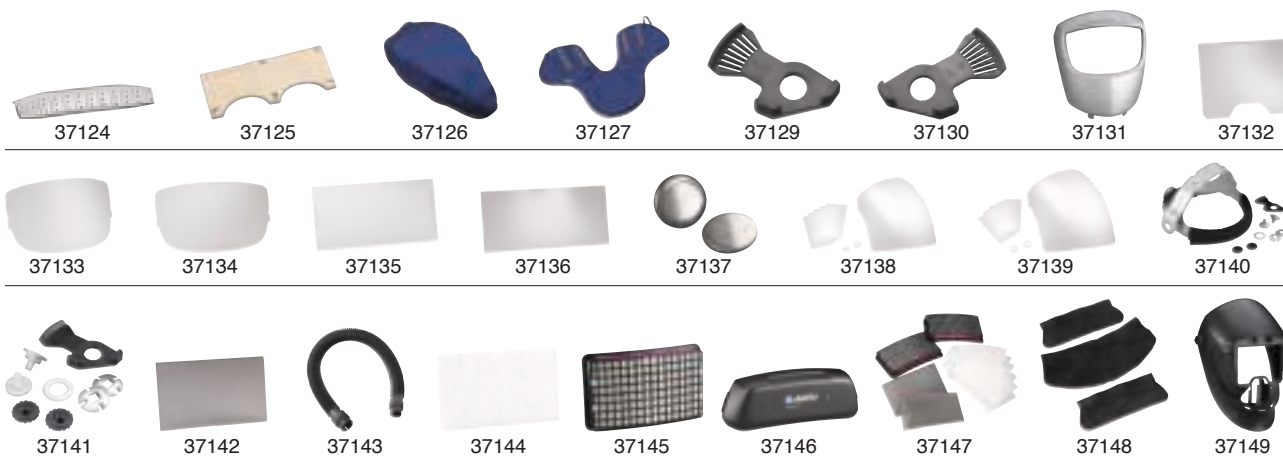

Head, Eye and Face Protection

3M™ Speedglas™ Lens 9000XF and Helmet with Side Windows



- Great for welders who want a really big view (extra large fixed dark shade).
- 44% larger than most auto-darkening lenses.
- Outstanding optical clarity.
- Low angle dependency.
- Includes side windows for increased peripheral vision with two shade 5 lenses which increase the viewing area an additional 100%.

Part Number	Quantity Per Case
051131-37120	1

Replacement Parts and Accessories

Part Number	Description	Quantity Per Case
051131-37124	Replacement Sweatband for Headband, Plastic	1
051131-37125	Replacement Sweatband for Headband, Leather	1
051131-37126	Headcover Standard Beret	1
051131-37127	Throat Protector	1
051131-37131	Helmet Silver Front Panel	1
051131-37132	FlexView Protection Plate	10
051131-37133	9000 Outside Protection Plate	10
051131-37134	HD Outside Protection Plate	5
051131-37135	9000 X/XF Inside Protection Plate	5
051131-37136	9000 V/F Inside Protection Plate	5
051131-37137	9000 Batteries	2
051131-37138	9000 X/XF Accessory Kit	1
051131-37139	9000 V/F Accessory Kit	1
051131-37140	9000 Headband with Mounting Hardware	1
051131-37141	9000 Mounting Hardware for Headband	1
051131-37148	3M™ Adflo™ Throat and Side Protector, Leather	1
051131-37149	9000 Helmet with Side Windows	1

3M™ Speedglas™ FlexView with Lens 9000XF SH 10 and Side Windows



- Great for welders who want a really big view and the flexibility of a lift up lens.
- Extra large fixed dark shade.
- 44% larger than most auto-darkening lenses.
- Outstanding optical clarity.
- Low angle dependency.
- FlexView system is the only product to offer users a clear visor combined with a “breathable” helmet with its four aerodynamically designed exhaust vents which reduce heat and humidity.

Part Number	Quantity Per Case
051131-37121	1

Replacement Parts and Accessories

Part Number	Description	Quantity Per Case
051131-37124	Replacement Sweatband for Headband, Plastic	1
051131-37125	Replacement Sweatband for Headband, Leather	1
051131-37126	Headcover Standard Beret	1
051131-37127	Throat Protector	1
051131-37130	FlexView Helmet/ Headband “S” Stop	10
051131-37132	FlexView Protection Plate	10
051131-37133	9000 Outside Protection Plate	10
051131-37137	9000 Batteries	2
051131-37140	9000 Headband with Mounting Hardware	1
051131-37141	9000 Mounting Hardware for Headband	1
051131-37148	3M™ Adflo™ Throat and Side Protector, Leather	1

Head, Eye and Face Protection

3M™ Speedglas™ Lens 9002X and Helmet with Side Windows



- Lenses are the most versatile auto-darkening welding lenses.
- Choose from 61 control combinations to select the most efficiency and comfort no matter what you are welding.
- 9002's newly developed detectors increase sensitivity to provide reliable switching for a wide range of welding methods.
- New delay function allows you to decide how quickly it changes from dark to light.

Part Number	Quantity Per Case
051131-37122	1

Replacement Parts and Accessories

Part Number	Description	Quantity Per Case
051131-37124	Replacement Sweatband for Headband, Plastic	1
051131-37125	Replacement Sweatband for Headband, Leather	1
051131-37126	Headcover Standard Beret	1
051131-37127	Throat Protector	1
051131-37131	Helmet Silver Front Panel	1
051131-37132	FlexView Protection Plate	10
051131-37133	9000 Outside Protection Plate	10
051131-37134	HD Outside Protection Plate	5
051131-37135	9000 X/XF Inside Protection Plate	5
051131-37136	9000 V/F Inside Protection Plate	5
051131-37137	9000 Batteries	2
051131-37138	9000 X/XF Accessory Kit	1
051131-37139	9000 V/F Accessory Kit	1
051131-37140	9000 Headband with Mounting Hardware	1
051131-37141	9000 Mounting Hardware for Headband	1
051131-37148	3M™ Adflo™ Throat and Side Protector, Leather	1
051131-37149	9000 Helmet with Side Windows	1

3M™ Speedglas™ FlexView with 3M™ Adflo™ PAPR (HE) with Side Windows and Lens 9000XF SH 10



- Combines the advantages of the FlexView helmets liftable shield with a clear visor for welding prep work, and the respiratory protection of the lightweight 3M™ Adflo™ PAPR system.
- Lightweight, the 3M™ Adflo™ system has no external batteries, no battery cables, and no sharp corners.
- Slim profile is designed to go into tight spaces.
- Unique belt design has a solid leather front, cut narrow to allow the welder to bend forward easily.
- Exclusive airflow pattern means well-distributed air throughout the entire breathing zone of the helmet.

Part Number	Quantity Per Case
051131-37123	1

Replacement Parts and Accessories

Part Number	Description	Quantity Per Case
051131-37124	Replacement Sweatband for Headband, Plastic	1
051131-37125	Replacement Sweatband for Headband, Leather	1
051131-37126	Headcover Standard Beret	1
051131-37127	Throat Protector	1
051131-37130	FlexView Helmet/ Headband "S" Stop	10
051131-37132	FlexView Protection Plate	10
051131-37133	9000 Outside Protection Plate	10
051131-37137	9000 Batteries	2
051131-37140	9000 Headband with Mounting Hardware	1
051131-37141	9000 Mounting Hardware for Headband	1
051131-37142	3M™ Adflo™ Spark Arrestor	2
051131-37143	3M™ Adflo™ Breathing Tube Assembly (Rubber)	1
051131-37144	3M™ Adflo™ Prefilter	6
051131-37145	3M™ Adflo™ Particle Filter, HE	2
051131-37146	3M™ Adflo™ Battery	1
051131-37147	3M™ Adflo™ Starter Kit, HE	1
051131-37148	3M™ Adflo™ Throat and Side Protector, Leather	1

3M™ Nomad™ Carpet Matting

3M™ Nomad™ Carpet Matting 4000

- Backed, dual fiber, ribbed pattern, light traffic carpet matting.

Part Number	Size	Color	Quantity Per Case
048011- 23748	2' x 3'	Charcoal	6
048011- 23749	2' x 3'	Brown	6
048011- 23750	2' x 3'	Lt. Gray	6
048011- 23764	2' x 3'	Cranberry	6
048011- 23767	3' x 5'	Charcoal	1
048011- 23768	3' x 5'	Brown	1
048011- 23769	3' x 5'	Lt. Gray	1
048011- 23322	3' x 5'	Hunter Green	1
048011- 23766	3' x 5'	Cranberry	1
048011- 23790	4' x 6'	Charcoal	1
048011- 23791	4' x 6'	Brown	1
048011- 23793	4' x 6'	Lt. Gray	1
048011- 23789	4' x 6'	Hunter Green	1
048011- 23788	4' x 6'	Cranberry	1

3M™ Safety-Walk™ Surfacing

3M™ Safety-Walk™ General Purpose Tread Pieces and Rolls

- High-friction textured material.
- Consists of abrasive mineral particles bonded by a tough, durable polymer to a dimensionally stable plastic film.
- Backing is coated with a pressure-sensitive adhesive covered by a removable protective liner.

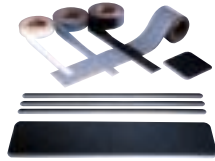

Part Number	Size	Color	Quantity Per Case
048011-19221	2" x 60'	Black	2
048011-26417	1" x 60'	Clear	4
048011-26419	2" x 60'	Clear	2
048011-26418	4" x 60'	Clear	1
048011-26422	1" x 60'	Yellow	4
048011-26421	2" x 60'	Yellow	2
048011-26420	4" x 60'	Yellow	1

3M™ Safety-Walk™ Conformable Tread Pieces and Rolls

- High-friction textured material.
- Consists of abrasive particles bonded by a tough, durable polymer to an aluminum foil backing.
- Backing is coated with a pressure-sensitive adhesive covered by a removable protective liner.

Part Number	Size	Color	Quantity Per Case
048011-19280	2" x 60'	Black	2
048011-19288	2" x 60'	Yellow	2
048011-19289	4" x 60'	Yellow	1
048011-19290	6" x 60'	Yellow	1

3M™ Safety-Walk™ Medium Resilient Tread Pieces and Rolls

- High-friction resilient textured material.
- Consists of dimensionally stable plastic film coated with a textured resilient surface.
- Reverse surface is coated with a pressure-sensitive adhesive covered by a removable protective liner.

Part Number	Size	Color	Quantity Per Case
048011-19320	6" x 24"	Gray	50
048011-19321	1" x 60'	Gray	4
048011-19323	2" x 60'	Gray	2
048011-19322	4" x 60'	Gray	1
048011-19324	6" x 60'	Gray	1
048011-19325	12" x 60'	Gray	1

3M™ Safety-Walk™ Fine Resilient Tread Pieces and Rolls

- A high-friction resilient textured material.
- Consists of a fine-textured resilient surface.
- Reverse surface is coated with a pressure-sensitive adhesive covered by a removable protective liner.



Part Number	Size	Color	Quantity Per Case
048011-19303	1" x 60'	Clear	4
048011-19304	2" x 60'	Clear	2
048011-19305	12" x 60'	Clear	1
048011-19315	1" x 60'	White	4
048011-19316	2" x 60'	White	2
048011-19317	4" x 60'	White	1
048011-19318	6" x 60'	White	1
048011-19319	12" x 60'	White	1

3M™ Safety-Walk™ Slip Resistant Coarse Tapes & Treads #710

- Consists of large abrasive particles bonded by a tough, durable polymer to a dimensionally stable plastic film.
- Reverse side is coated with a pressure-sensitive adhesive covered by a removable protective liner.

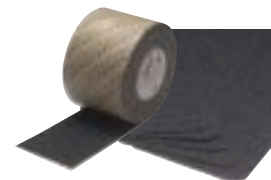

Part Number	Size	Rolls Per Case
048011-34729	6" x 24"	25
048011-34730	4" x 30'	1
048011-34731	6" x 30'	1
048011-34732	12" x 30'	1
048011-34733	18" x 30'	1
048011-34734	24" x 30'	1

3M™ Safety-Walk™ Deals

3M™ Safety-Walk™ Medium Resilient Surfacing Medium Duty Deal H-124

- Deal contains one roll each of 3M™ Safety-Walk™ Medium Resilient Tread Pieces and Rolls PNs 19321, 19322 and 19323 plus an attractive dispenser rack.
- Catalog Number 07735.

Part Number	Contents	Rolls Per Deal	Deals Per Case
051131-59505	1 Roll 1" x 60' Gray 1 Roll 2" x 60' Gray 1 Roll 4" x 60' Gray	3	1

3M™ Safety-Walk™ Medium Resilient Surfacing Medium Duty Deal H-124

- Deal contains one roll each of 3M™ Safety-Walk™ Medium Resilient Tread Pieces and Rolls PNs 19293, 19294, and 19296 plus an attractive dispenser rack.
- Catalog Number 07734.



Part Number	Contents	Rolls Per Deal	Deals Per Case
051131-59509	1 Roll 1" x 60' Black 1 Roll 2" x 60' Black 1 Roll 4" x 60' Black	3	1

3M™ Safety-Walk™ General Purpose Surfacing General Purpose Deal S-124

- Deal contains one roll each of 3M™ Safety-Walk™ General Purpose Tread Pieces and Rolls PNs 19220, 19221, and 19223 plus an attractive dispenser rack.
- Catalog Number 07730.

Part Number	Contents	Rolls Per Deal	Deals Per Case
051131-59513	1 Roll 1" x 60' Black 1 Roll 2" x 60' Black 1 Roll 4" x 60' Black	3	1

3M™ Safety-Walk™ General Purpose Surfacing Heavy-Duty Deal S-124

- Deal contains one roll each of 3M™ Safety-Walk™ General Purpose Tread Pieces and Rolls PNs 26417, 26418 and 26419 plus an attractive dispenser rack.
- Catalog Number 07729.

Part Number	Contents	Rolls Per Deal	Deals Per Case
051131-59517	1 Roll 1" x 60' Clear 1 Roll 2" x 60' Clear 1 Roll 4" x 60' Clear	3	1

3M™ Safety-Walk™ Application Accessories

3M™ Safety-Walk™ Primer

- A liquid solvent-based adhesive applied to porous surfaces before applying matting products.
- One quart covers approximately 35 square feet.



Part Number	Size	Quarts Per Case
048011-19339	Quart	1

3M™ Safety-Walk™ Rubber Hand Roller

- Helps provide a firm bond when applying all 3M™ Safety-Walk™ products.

Part Number	Size	Each Per Case
048011-19341	1-3/8" D x 2" W x 6" L	1

3M™ Safety-Walk™ Edge Sealing Compound

- A liquid solvent-based sealer in a convenient tube applicator.
- Seals the exposed edges of 3M™ Safety-Walk™ products providing extra protection from excessive moisture or liquids.
- One five-ounce tube seals approximately 75 to 100 linear feet.



Part Number	Size	Tubes Per Case
048011-19340	5 oz. Tube	1

3M™ Vangard™ Lenses

3M™ Vangard™ Window Lenses

- Wide-angle window lenses show obstacles hiding out of sight.
- Product is packaged with an open window so customer can see actual product.
- Easily applied and removed by hand using water only.



Part Number	Description	Size	Quantity Per Case
051131-07950	3M™ Vangard™	8" x 10"	12
051131-07951	3M™ Super Vangard™	11" x 14"	12
051131-07952	3M™ Vangard™ 2	6" x 8"	12

Retail Safety Products

3M™ Sanding Respirator

- Provides extra protection and greater comfort during sanding, body work and repair projects.
- Each has a lightweight construction that helps people stay cool and comfortable.
- Patented material filters at least 95% of non-oil airborne particles.
- Government-approved N95 respirator with braided straps for greater comfort.



Part Number	Respirators Per Pack	Packs Per Case
051111-03201	2	12

3M™ Boas™ Protective Eyewear — Retail Package

- Feature a tough, polycarbonate lens that resists shattering.
- Provides comfortable protection during projects like auto repairs.
- 99% UV protection.
- Lightweight for comfortable wear.
- Stylish, contemporary design.



Part Number	Color Frame/Lens	Pairs Per Case
051131-91536	Black/Clear	10

3M™ Corded Ear Plugs

- Made of soft, hypo-allergenic foam.
- Tapered shape.
- Attached to a soft, braided cord that drapes without twisting or binding.
- Noise reduction of 28dB.



Part Number	Pairs Per Pack	Packs Per Case
051131-86962	2	12

3M™ Low Profile Ear Muffs

- Economical, dependable, lightweight ear muff ideal for everyday use.
- Soft, foam-filled cushions and an easy-slide adjustable headband create a comfortable, customized fit.
- Noise reduction of 22dB.

Part Number	Pairs Per Case
051131-91537	10

3M™ Protective Eyewear Display

- Revolving display comes fully loaded with an assortment of 24 pairs of protective eyewear; ready to place on a counter and sell.
- Can also be mounted on a slat wall or pegboard in any retail environment.
- Reload with standard 3M™ Protective Eyewear (PNs 37113, 37114, 37115 and 37116).



Part Number	Displays Per Case
051131-91522	1

Adhesives, Coatings and Sealers



Products

Adhesives	153–155
Applicator Guns and Accessories	146
3M™ Automix™ Product Line	143–146
Coatings	160–163
Duramix™ Product Line	147–152
Emblem Adhesives	154
Plastic Parts/ Bumper Repair	153
Retail Products	164
Seam Sealers	156–159
Silicone Sealants	159
Weatherstrip Adhesives	153
Welding Products	152

Adhesives, Coatings and Sealers



3M™ Automix™ Products

3M™ Automix™ Shop Rack

- Shop rack for all 6 oz. and 200ml syringes.
- Holds 11 open syringes.
- Rack holds 2 applicator guns.



Part Number	Containers Per Case
051131-02530	6

3M™ Automix™ Fast Cure Epoxy Adhesive

- Two-part clear epoxy that delivers strong, durable bonds within minutes after application.
- Makes difficult repair jobs easy when used to join parts made of plastic, metal, glass, fiberglass, wood, etc.
- 3-5 minute work life.
- Handling strength reached in about 5 minutes, with full cure in one hour.
- Use with 3M™ Automix™ Applicator Gun (PN08191) and Mixing Nozzles Clear (PN08197).



Part Number	Packs Per Case
051135-08107	6

3M™ Automix™ Panel Bonding Adhesive

- A two-part structural adhesive that may be used to bond either steel or aluminum body panels.
- Long work time.
- Cures on demand with heat application.
- Eliminates corrosion normally caused by welding.
- Use with MixPac® Applicator Gun (PN08117).



Part Number	Each Per Case
051135-08115	6

MixPac® is a registered trademark of MixPac® Systems AG, Switzerland.

3M™ Automix™ Panel Bonding Adhesive

- A two-part adhesive that may be used to bond steel, aluminum body panels, SMC or FRP body panels.
- Long work life.
- Cures on demand with heat application.
- Eliminates corrosion normally caused by welding.
- For use with Mixpac® Applicator Gun (PN08117).
- Meets GM 6449G and DaimlerChrysler MS-CD 507.



Part Number	Size	Cartridges Per Case
051135-08116	200ml (6.75 oz)	6

MixPac® is a registered trademark of MixPac® Systems AG, Switzerland.

3M™ Super Fast Adhesive Cleaner

- For removing adhesives, bugs, grease/oils, overspray, silicones, waxes, and tars.
- Super fast working.
- More aggressive than 3M™ General Purpose Adhesive Cleaner (PN08984).



Part Number	Container Size	Containers Per Case
051135-08215*	Quart	6

* This product cannot be purchased for use in Southern California per the California South Coast Air Quality District Rule 1171.

3M™ Automix™ Universal Adhesive

- General purpose adhesive for metal, glass, and plastic.
- Work time 3 minutes.
- Handling time 25 minutes.
- Use with MixPac® Applicator Gun (PN08117—manual or PN09930—pneumatic). To order PN09930, call Shopware at 1-800-877-9344. (Not stocked as a 3M item.)
- Use with 3M™ Automix™ Mixing Nozzle (PN08193).



Part Number	Color	Cure Time	Container Size	Containers Per Case
051135-08217	Clear	1 Hour	200ml Syringe	6
051135-08223	Black	4 Hours	200ml Syringe	6

MixPac® is a registered trademark of MixPac® Systems AG, Switzerland.

3M™ Automix™ SMC/ Fiberglass Panel Adhesive

- Used for structural bonding SMC/FRP panels to frames.
- Work time 30 minutes.
- Handling time 2 hours.
- Cure time 24 hours.
- Use with MixPac® Applicator Gun (PN08117—manual or PN09930—pneumatic). To order PN09930, call Shopware at 1-800-877-9344. (Not stocked as a 3M item.)
- Use with 3M™ Automix™ Mixing Nozzle (PN08193).



Part Number	Container Size	Containers Per Case
051135-08219	200ml Syringe	6

MixPac® is a registered trademark of MixPac® Systems AG, Switzerland.

3M™ Automix™ Products

3M™ Quick Fix Adhesive Kit

- Rapidly bonds rubber, metal and most plastics.
- Instantly bonds those materials when used with accelerator included.
- Kit includes 0.7 oz. adhesive and 2 oz. accelerator.



Part Number	Container Size	Containers Per Case
051135- 08224	Kit	6

3M™ Automix™ SMC Fiberglass Repair Adhesive

- Use for adhering backup strips and patches.
- Available in two work times.
- Use with MixPac® Applicator Gun (PN08117—manual or PN09930—pneumatic). To order PN09930, call Shopware at 1-800-877-9344. (Not stocked as a 3M item.)
- Use with 3M™ Automix™ Mixing Nozzle (PN08193).



Part Number	Work Time	Handling Time	Cure Time	Container Size	Containers Per Case
051135- 08227	4 Minutes	30 Minutes	2 Hours	200ml Syringe	6
051135- 08243	50 Seconds	15 Minutes	1 Hour	200ml Syringe	6

MixPac® is a registered trademark of MixPac® Systems AG, Switzerland.

3M™ Automix™ Door Skin Bonding

- Use for bonding door skins.
- Work time 60 minutes.
- Handling time 4 hours.
- Cure time 24 hours.
- Not for SMC door skins.
- Use with MixPac® Applicator Gun (PN08117—manual or PN09930—pneumatic). To order PN09930, call Shopware at 1-800-877-9344. (Not stocked as a 3M item.)
- Use with 3M™ Automix™ Mixing Nozzle (PN08193).



Part Number	Container Size	Containers Per Case
051135- 08229	200ml Syringe	6

MixPac® is a registered trademark of MixPac® Systems AG, Switzerland.

3M™ Automix™ Semi-Rigid Parts Repair

- Use to repair Xenoy®, RRIM, FTX, PPO, ABS and a variety of other semi-rigid plastic parts and bumper covers.
- Available in two work times.
- Use with MixPac® Applicator Gun (PN08117—manual or PN09930—pneumatic). To order PN09930, call Shopware at 1-800-877-9344. (Not stocked as a 3M item.)
- Use with 3M™ Automix™ Mixing Nozzle (PN08193).



Part Number	Work Time	Sand Time	Cure Time	Container Size	Containers Per Case
051135- 08235	50 Seconds	15 Minutes	1 Hour	200ml Syringe	6
051135- 08237	3 Minutes	30 Minutes	4 Hours	200ml Syringe	6

Xenoy® is a registered trademark of General Electric Company. MixPac® is a registered trademark of MixPac® Systems AG, Switzerland.

3M™ Automix™ TPO Plastic Parts Repair

- Use to repair TPO plastics including PP, EP, EPDM, TEO and Metton®.
- Use with 3M™ Automix™ Polyolefin Adhesion Promoter (PN05907).
- Work time 50 seconds.
- Sand time 30 minutes.
- Cure time 1 hour.



Part Number	Container Size	Containers Per Case
051131- 08239	200ml Syringe	6

Metton® is a registered trademark of Teijin-Metton Co., Ltd.

3M™ Automix™ Truck Line SMC/Fiberglass Repair Adhesive-3

- Two-part urethane used to bond backup strips and patches to SMC and FRP (traditional fiberglass).
- Automatic mixing.
- Excellent sag resistance.
- Longer work time than 3M™ Automix™ Truck Line SMC/Fiberglass Repair Adhesive-1 (PN08270) for repairs requiring larger backup strips and patch applications.
- Excellent for bonding headlamp buckets.
- Achieves maximum work strength fast.
- Work time 3 minutes.
- Clamp time 10 minutes.
- Cure time 30 minutes.



Part Number	Container Size	Containers Per Case
051135- 08267	600ml Syringe	6
051135- 08271	400ml Syringe	6

3M™ Automix™ Products

3M™ Automix™ Truck Line SMC/Fiberglass Repair Adhesive-10

- Two-part urethane used to adhere SMC and FRP (traditional fiberglass) body panels to each other and to metal frames. Metal must be primed with two-part primer 3M™ Automix™ Truck Line Adhesive Primer (PN08278).
- Automatic mixing.
- Excellent sag resistance.
- Long work time for bonding SMC and FRP (traditional fiberglass) fender and hood.
- Work time 10 minutes.
- Clamp time 30 minutes.
- Cure time 60 minutes.



Part Number	Container Size	Containers Per Case
051135-08268	600ml Syringe	6
051135-08272	400ml Syringe	6

3M™ Automix™ Truck Line SMC/Fiberglass Repair Adhesive-35

- Two-part urethane used to adhere SMC and FRP (traditional fiberglass) body panels to each other and to metal frames. Metal must be primed with two-part primer 3M™ Automix™ Truck Line Adhesive Primer (PN08278).
- Automatic mixing.
- Excellent sag resistance.
- Long work time for bonding SMC and FRP (traditional fiberglass) fender and hood.
- Work time 35 minutes.
- Clamp time 1.5 hours.
- Cure time 3 hours.



Part Number	Container Size	Containers Per Case
051135-08269	600ml Syringe	6
051135-08273	400ml Syringe	6

3M™ Automix™ Truck Line SMC/Fiberglass Repair Adhesive-1

- Two-part urethane used to bond backup strips to SMC and FRP (traditional fiberglass).
- Automatic mixing.
- Excellent sag resistance.
- Fast work time for small backup strips and patch applications.
- Achieves maximum work strength fast.
- Work time 1.5 minutes.
- Clamp time 5 minutes.
- Cure time 10 minutes.



Part Number	Container Size	Containers Per Case
051135-08270	400ml Syringe	6

3M™ Automix™ Truck Line SMC/Fiberglass Repair Adhesive-90

- Two-part epoxy used to bond steel, aluminum, SMC and FRP (traditional fiberglass) body panels to each other and to metal frames (no primer required).
- Automatic mixing.
- Excellent sag resistance.
- Longest work time for bonding large areas, i.e. hoods and roof caps.
- Work time 90 minutes.
- Clamp time 4 hours.
- Cure time 24 hours.



Part Number	Container Size	Containers Per Case
051135-08274	400ml Syringe	6

3M™ Automix™ Truck Line EZ Sand Rigid Parts Repair

- Two-part epoxy used to repair SMC, FRP (traditional fiberglass) and other rigid plastic parts.
- Excellent choice for cosmetic repairs.
- Automatic mixing.
- Designed to be used as a filler and adhesive.
- Epoxy based for easy sanding.
- Formulated for excellent featheredge.
- Work time 10 minutes.
- Sand time 30 minutes.
- Cure time 4 hours.



Part Number	Container Size	Containers Per Case
051135-08275	400ml Syringe	6

3M™ Automix™ Truck Line Fiberglass Matting Adhesive

- A low viscosity two-part urethane used to saturate fiberglass cloth when preparing backup patches.
- The self-leveling feature can be used for filling cracks, channels and areas restricting the application of an adhesive bead.
- Work time 10 minutes.
- Sand time 50 minutes.



Part Number	Container Size	Containers Per Case
051135-08277	400ml Syringe	6

3M™ Automix™ Products

Mixpac® Applicator Gun

- A pneumatic applicator gun designed for use with the 400 ml cartridges.
- 1:1 and 2:1 mixing ratios.
- Available from Shopware Inc.
Phone # 1-800-877-9344
Fax # 952-392-2018 for order form
- Also available in a manual version from Shopware — Mixman 400.



Part Number	Quantity Per Case
051135- 08280 (Not stocked as a 3M item.)	1

Mixpac® is a registered trademark of Mixpac® Systems AG, Switzerland.

3M™ Automix™ Pillar Foam

- Rigid foam for applications where OEM rigid foam is apparent.
- Dwell time 1 minute.
- Work time 5 minutes.
- Cure time 1 hour.



Part Number	Container Size	Containers Per Case
051135- 08458	200ml Syringe	6

3M™ Automix™ Flexible Foam

- For those applications where OEM flexible foams are found.
- Dwell time 1 minute.
- Work time 5 minutes.
- Cure time 1 hour.



Part Number	Container Size	Containers Per Case
051131- 08463	200ml Syringe	6

3M™ Automix™ EZ Sand Rigid Parts Repair

- A two-part structural adhesive and filler designed to bond and fill SMC, fiberglass reinforced plastics and other rigid plastic parts.
- To be used when attaching bonding strips and making cosmetic repairs.
- The 3M™ Automix™ EZ Sand Rigid Parts Repair Kit (PN05883) contains two 5 oz. tubes.



Part Number	Container Size	Containers Per Case
051131- 05885	200ml Syringe	6

3M™ Automix™ EZ Sand Flexible Parts Repair

- Can be used to repair most of the plastic parts found on today's vehicles.
- Very easy to sand.
- Excellent featheredging properties.
- Dispensed effortlessly from the tubes and mixes easily and completely.
- Cartridge offers automatic metering of Parts A and B and the option to use the mixing nozzle for automatic mixing.
- The 3M™ Automix™ EZ Sand Flexible Parts Repair Kit (PNs 05895 and 05896) contains two tubes for easy mixing.



Part Number	Container Size	Containers Per Case
051131- 05887	200ml Syringe	6

3M™ Automix™ Self-Leveling Seam Sealer

- Provides unique self-leveling properties.
- No shrinkage.
- Will cure to a smooth and hard finish in less than one hour.
- Fast paint over times.
- A heat gun may be used to provide leveling instead of tooling.



Part Number	Container Size	Containers Per Case
051135- 08307	200ml Syringe	6

3M™ Automix™ Heavy-Bodied Seam Sealer

- Two-part epoxy, heavy-body seam sealer for use in vertical or horizontal seams to match OEM sealers.
- Excellent tooling properties.
- No shrinkage.
- Beads will remain in the same size and shape as extruded.
- Fast paint over times.
- Will cure to a smooth and hard finish in less than one hour.



Part Number	Container Size	Containers Per Case
08308*	200ml Syringe	6

*UPC Bar Code 051131-16808

Duramix™ Products

Duramix™ Flexible Plastic Repair

- Flexible urethane repair material for repairs on non-T.P.O. flexible bumpers or parts.
- Set time 1 minute.
- Sandable in 15 minutes.
- Will not peel back when sanded.



Part Number	Cartridge Size	Cartridges Per Case
051131-04030	6 oz.	6

Duramix™ Semi-Rigid General Purpose Adhesive & Repair

- Slower counterpart to the fast working Semi-Rigid Plastic Repair (PN04040).



Part Number	Cartridge Size	Cartridges Per Case
051131-04041	6 fl. oz.	6

Duramix™ General Purpose Repair & Adhesive Material, Flexible

- Slower and more flexible counterpart to the fast working Flexible Plastic Repair (PN04030).



Part Number	Cartridge Size	Cartridges Per Case
051131-04031	6 oz.	6

Duramix™ Semi-Rigid Plastic Repair – Opaque

- Slower counterpart to the fast working Semi-Rigid Plastic Repair (PN04040).
- Semi-rigid urethane material for repairing Xenoy®, HPA, ABS, PPO, SAN, PA, GTX, UP, SRIM, RRIM and other semi-rigid plastic parts and bumper covers.
- Sets within 1 minute.
- Opaque in color



Part Number	Cartridge Size	Cartridges Per Case
051131-04045	6 fl. oz.	6

Xenoy® is a registered trademark of General Electric Company.

Duramix™ Thermoplastic Olefin Repair (T.P.O.)

- Flexible urethane for repairing T.P.O.-type plastics including T.E.O., Metton, Polypropylene and EPDM.
- Simulates the properties of olefinic plastics.
- Set time 1 minute.
- Sandable in 15 minutes.
- Use in conjunction with T.P.O. Adhesion Promoter (PNs 04524 or 04924).



Part Number	Cartridge Size	Cartridges Per Case
051131-04036	6 oz.	6

Duramix™ SMC Fiberglass Backer Repair (Fast Set)

- A rigid urethane material for quick bonding of flexible and light-cure backer laminates when contouring and shaping is required, and for quick bonding of Fiberglass Backer Panels (PN04916).



Part Number	Cartridge Size	Cartridges Per Case
051131-04050	6 fl. oz.	6

Duramix™ Semi-Rigid Plastic Repair

- Semi-rigid urethane material for repairing Xenoy®, HPA, ABS, PPO, SAN, PA, GTX, UP, SRIM, RRIM and other semi-rigid plastic parts and bumper covers.
- Sets within 1 minute.
- Sandable in 15 minutes.



Part Number	Cartridge Size	Cartridges Per Case
051131-04040	6 oz.	6

Xenoy® is a registered trademark of General Electric Company.

Duramix™ Rapid Patch Urethane Repair Kit

- For rigid repairs.
- Two-component, urethane paste system packaged in metal squeeze tubes.
- Included in kit are mixing pads (10 tear-away sheets) and mixing spatulas.
- Sands very easily and excellent for filling pinholes or feathering other Duramix™ products, should it be necessary.
- Work time is approximately 2-1/2 minutes.
- Sanding time approximately 15 minutes.



Part Number	Net Size	Kits Per Case
051131-04052	6 fl. oz.	12

Duramix™ Products

Duramix™ E-Z Sand Plastic Finishing Paste

- For back-filling pinholes in repair areas of urethane or T.P.O. plastic bumpers and panels.
- Easy to use.
- Produces excellent, non-swelling cosmetic base for primers and sealers.
- Eliminates haloing.
- No mixer tip required.



Part Number	Cartridge Size	Cartridges Per Case
051131-04058	6 fl. oz.	6

Duramix™ Universal Adhesive

- Flexible urethane for bonding plastic add-on parts, such as spoilers, flares, air dams, impact strips, emblems and various other ground effects parts to metal or plastic panels.
- Tough, flexible bond prevents cracking.
- Allows repositioning of impact strips during application.
- Work time 10 minutes.
- Set time 30 minutes.



Part Number	Cartridge Size	Cartridges Per Case
051131-04125	6 fl. oz.	6

Duramix™ Super Fast Adhesive

- Super fast-setting adhesive which does not require a separate accelerator like cyanacrylate adhesives.
- Will not run or sag.



Part Number	Cartridge Size	Cartridges Per Case
051131-04147	6 fl. oz.	6

Duramix™ Side Glass Channel Adhesive

- Semi-rigid urethane material for bonding side glass to metal or plastic channels.
- Sets within 3 minutes.
- Glass becomes structurally bonded to channel within 10 minutes.



Part Number	Cartridge Size	Cartridges Per Case
051131-04150	6 fl. oz.	6

Duramix™ SMC Panel Splicing Adhesive

- Semi-rigid adhesive for splicing and bonding SMC/fiberglass backer panels.
- Ideal for reinforcing crushed or punctured fiberglass.
- Sets up quickly to form a tenacious bond.



Part Number	Cartridge Size	Cartridges Per Case
051131-04154	6 fl. oz.	6

Duramix™ Small Metal Panel Adhesive

- Exceptionally strong urethane adhesive for bonding steel parts, such as fenders and quarter panels, where a 20 minute work time is needed.
- Bond or declamp time is 4 hours. (Use heat to reduce declamp time to 1-1/2 hours.)



Part Number	Cartridge Size	Cartridges Per Case
051131-04176	6 fl. oz.	6

Duramix™ Medium Metal Panel & Doorskin Adhesive

- Tenacious bonding doorskin adhesive that can also be used to bond steel parts when a 45-minute work time is desired.
- Bonds doorskins in 2 hours; other panels and parts are bonded in 6 hours. (Use heat to reduce declamp time to 1-1/2 hours.)



Part Number	Cartridge Size	Cartridges Per Case
051131-04178	6 fl. oz.	6

Duramix™ Large Metal Panel Adhesive

- Excellent urethane adhesive for bonding large steel parts, such as large quarter panels and roofskins.
- Has a 60-minute work time and a 6-hour bond or declamping time. (Use heat to reduce declamping time to 1-1/2 hours.)



Part Number	Cartridge Size	Cartridges Per Case
051131-04179	6 fl. oz.	6

Duramix™ Products

Duramix™ Small SMC Fiberglass Panel Adhesive

- Faster version of Large SMC Fiberglass Panel Adhesive (PN04188) that allows clamps to be removed sooner.
- Work time 20 minutes.
- Clamp time 4 hours.



Part Number	Cartridge Size	Cartridges Per Case
051131-04186	6 fl. oz.	6

Duramix™ Flexible Self-Leveling Seam Sealer

- Flexible urethane formulation.
- Self-leveling quality makes this ideal for vehicles that have channel voids or cracked seams to fill.



Part Number	Cartridge Size	Cartridges Per Case
051131-04227	6 fl. oz.	6

Duramix™ Large SMC Fiberglass Panel Adhesive

- Rigid urethane that produces a tough bond on SMC and fiberglass panels.
- Excellent for bonding panels on MPV/APV vans and Corvettes.
- Work time 60 minutes.
- Bond time 6 hours.



Part Number	Cartridge Size	Cartridges Per Case
051131-04188	6 fl. oz.	6
04189*	12 fl. oz.	6

*UPC Bar Code 021200-96354

Duramix™ Controlled-Flow Seam Sealer

- Will run approximately 1-1/2 to 2 inches when applied at a 45° angle.
- Excellent for sloped areas.

Part Number	Cartridge Size	Cartridges Per Case
051131-04229	6 fl. oz.	6

Duramix™ Semi-Rigid Plastic Repair

- A material for repairing virtually all plastics and bumper covers.
- Sets in 1 minute and sands after 15 minutes.



Part Number	Cartridge Size	Cartridges Per Case
051131-04240	200ml	6

Duramix™ Factory Match Doorskin Sealer

- Flows slightly and softens on the edges, without tooling, giving a rounded appearance as if applied at the factory.
- Use to duplicate factory doorskin seams as well as various other factory seams.



Part Number	Cartridge Size	Color	Cartridges Per Case
051131-04223	6 fl. oz.	Black	6

Duramix™ Super Fast Repair Adhesive

- A super fast-setting adhesive and repair material for rebuilding tab and fixing broken eyelets.
- Has excellent gap filling capabilities and withstands a wide range of temperatures, unlike cyanoacrylates.



Part Number	Cartridge Size	Cartridges Per Case
051131-04247	200ml	6

Duramix™ Seam Sealer

- Flexible urethane for sealing channels and seams.
- Protects against moisture by stopping water and air leaks.
- Will not shrink or crack.
- Withstands vibrations and temperature extremes.
- Sets in 20 minutes and can be painted in 1 hour.



Part Number	Cartridge Size	Color	Cartridges Per Case
051131-04225	6 fl. oz.	Amber	6
051131-04226	6 fl. oz.	Black	6

Duramix™ NVH (Noise, Vibration, Harshness) Dampening Material

- Ideal 2-part urethane product for replacing factory NVH sealants and foams.
- Work time of 60 minutes offers plenty of time for large installations.
- Remains very soft, yet sturdy and will not degrade.

Part Number	Container Size	Containers Per Case
051131-04274	200ml	6

Duramix™ Products

Duramix™ Flexible Foam

- Flexible urethane foam applies to panels without sagging.
- Designed to duplicate OEM foams.
- Stops flutter and dampens sound in panels, under hoods and inside doorskins.
- Does not require moisture to cure.
- Rises within 5 seconds.
- Set time 1 minute.
- For use with Mixer Tips for Foam Products (PN04907).



Part Number	Cartridge Size	Cartridges Per Case
051131-04320	6 fl. oz.	6

Duramix™ Pillar Foam

- A flowable, semi-rigid urethane foam for pillars and posts.
- Provides partial reinforcement and NVH (Noise, Vibration, Harshness) reduction.
- Has flow properties to fill a two-foot section.
- Does not require moisture to cure.
- Rises within 10 seconds and sets within 2 minutes.
- For use with Mixer Tips for Foam Products (PN04907).

Part Number	Cartridge Size	Cartridges Per Case
051131-04330	6 fl. oz.	6

Duramix™ Semi-Rigid Foam

- Semi-rigid urethane foam applies to vertical panels without sagging.
- Seals air and water leaks.
- Excellent for sealing around gas tank filler area.
- Can also be used to stop flutter and vibrations on thick panels.
- Does not require moisture to cure.
- For use with Mixer Tips for Foam Products (PN04907).

Part Number	Cartridge Size	Cartridges Per Case
051131-04350	6 fl. oz.	6

Duramix™ NVH Dampening Material

- Flexible material for NVH (Noise, Vibration, Harshness) dampening.
- Use when a long work time is needed, such as when dampening roofskins.
- Excellent for thin gaps where foams are difficult to use.
- Remains flexible in all weather.
- NOTE: This is not a foam, although it does perform the same dampening function as a foam. Do not use a PN04907 Foam Mixer Tip with this product.



Part Number	Cartridge Size	Cartridges Per Case
051131-04374	6 fl. oz.	6

Duramix™ Super Fast Adhesive

- Super fast-setting adhesive which does not require a separate accelerator like cyanacrylate adhesives.
- Has excellent wide gap filling capabilities and withstands a wide range of temperatures.
- Will not run or sag.



Part Number	Size	Quantity Per Case
051131-04747	50 cc	12

Duramix™ Introductory Kit

- Kit contains one each:
 - Duramix™ Semi-Rigid Plastic Repair (PN04040)*
 - Duramix™ E-Z Sand Plastic Finishing Paste (PN04058)
 - Duramix™ Large Metal Panel Adhesive (PN04179)*
 - Duramix™ Dispenser (PN04997)



Part Number	Kits Per Case
051131-04806	1

* Each package contains a 6 fluid ounce cartridge and 1 mixer tip.

Duramix™ Super-Fast 50cc Kit

- Kit contains six each:
 - Duramix™ Super-Fast Adhesive – Clear (PN04747)*
- Kit contains one each:
 - Duramix™ Mixer Tips (PN04909) – Bag of 6
 - Duramix™ 50cc Dispenser (PN04991)



Part Number	Kits Per Case
051131-04847	1

* Each package contains a 50cc cartridge and 1 mixer tip.

3M™ Mixer Tips (Non-Tapered)

- Non-tapered, standard tip.
- Produces a heavy bead used for most repair and bonding situations.



Part Number	Tips Per Bag	Bags Per Case
051131-04901	12	3
051131-04914	50	1

Duramix™ Products

Duramix™ Mixer Tips (Tapered)

- Tapered, fine tip.
- Allows you to apply a fine bead for use in bonding impact strips and sealing small seams, as well as many other applications where a fine bead is required.
- Can be cut to the desired bead thickness.
- Use with OEM Seam Sealer Nozzle (PN04926) and OEM Seam Sealer Nozzle with Guide (PN04927).



Part Number	Tips Per Bag	Bags Per Case
051131-04902	12	3

Duramix™ Plastic Contour Sheet

- Special film to be overlaid on Duramix™ just after it has been applied.
- Prevents air entrapment when Duramix™ is condensed and contoured into the repair area.
- Allows for non-messy spreading of Duramix™.

Part Number	Size	Rolls Per Case
051131-04903	5" Wide x 12' Long	6

Duramix™ Reinforcement Patch

- Laminate of structural gauze and plastic release film.
- Used for reinforcing the backside of plastic repairs.
- Release film protects your hand from contact with wet Duramix™.



Part Number	Size	Rolls Per Case
051131-04904	5" Wide x 12' Long	6

3M™ Mixer Tips for Foam Products

- Designed to be used specifically with Duramix™ foam products (PNs 04320, 04330 and 04350).



Part Number	Tips Per Bag	Bags Per Case
051131-04907	12	3

Duramix™ Mixer Tips for 20cc and 50cc Products

- Smaller tips to be used with Duramix™ 20cc and 50cc products.



Part Number	Tips Per Bag	Bags Per Case
051131-04909	6	6
051131-04908	50	1

Duramix™ Plastic Parts Prep & Cleaner

- A high quality, water-based cleaner specially designed for plastic parts cleaning and all other surfaces.
- Removes dirt, oil, grease and release agents efficiently.
- Quick drying.



Part Number	Size	Each Per Case
051131-04910	32 fl. oz. Spray Bottle	6

Duramix™ Plastic Parts Prep & Cleaner

- A water-based plastic cleaner.
- Ideal for removing oily and waxy residue, especially on the T.P.O.-type plastic.



Part Number	Size	Each Per Case
051131-04912	4 fl. oz. Spray Bottle	6

Duramix™ Thermoplastic Olefin (T.P.O.) Adhesion Promoter

- Improves bonding between Duramix™ repair materials and T.P.O., T.E.O., Metton Polypropylene and EPDM plastics.
- Produces a semi-structural bond for mending and filling cosmetic areas on bumper covers and other T.P.O.-type plastic parts.
- Use in conjunction with T.P.O. Repair (PN04036).



Part Number	Size	Each Per Case
051131-04924	4 fl. oz. Can	6

Duramix™ OEM Seam Sealer Nozzle

- For use with Duramix™ Mixer Tip (PN04902).
- Allows you to easily create a ribbon bead when sealing seams.

Part Number	Nozzles Per Bag	Bags Per Case
051131-04926	12	3

Duramix™ OEM Seam Sealer Nozzle with Guide

- Includes attached guide for precision applications.
- For use with Duramix™ Mixer Tip (PN04902).
- Allows you to easily create a ribbon bead when sealing seams.



Part Number	Nozzles Per Bag	Bags Per Case
051131-04927	12	3

Duramix™ Products

Duramix™ Pneumatic Dispenser

- Easy-to-use pneumatic gun for dispensing 6 oz. Duramix™ cartridges.



Part Number	Each Per Case
051131-04947	1

Duramix™ 50 cc Dispenser

- High quality Duramix™ gun for dispensing of 50 cc cartridges.



Part Number	Each Per Case
051131-04991	1

Duramix™ Dispenser

- High quality Duramix™ gun for heavy-duty dispensing of 6 oz. cartridges.
- Protects cartridge and dispenses cartridges with broken flanges.



Part Number	Each Per Case
051131-04997	1

Welding Products

3M™ Welding and Spark Deflection Paper

- Flame retardant.
- Repositionable adhesive on one side.
- Formulated to protect vertical surfaces, glass and paint from welding spatter and grinding sparks.
- Easy to use roll form.



Part Number	Roll Size	Rolls Per Case
051131-05916	24" x 150'	2

3M™ Weld-Thru Coating Silver

- An aerosol coating designed to be applied to metal surfaces prior to welding which permits corrosion protection after the weld.
- Dries fast (10-15 minutes).
- Minimizes MIG weld spatter.
- May be applied after the weld for additional corrosion protection.



Part Number	Net Wt.	Cans Per Case
051131-05913	13 oz. Aerosol	12

3M™ Welding and Spark Deflection Dispenser

- Dispenses single rolls of 24" 3M™ Welding and Spark Deflection Paper.
- Can be wall or table mounted.
- Very easy to assemble.



Part Number	Quantity Per Case
051131-05912	1

3M™ High Performance Welding Drape

- Extreme resistance to heat, sparks, welding spatter and flames.
- Ideal for protection from automotive welding spatter and grinding sparks.
- Very lightweight, conformable and easy to handle.
- Excellent wear and tear resistance.
- Easy to clean by brushing or shaking.



Part Number	Size	Quantity Per Case
051131-05919	57" x 80"	1

Plastic Parts and Bumper Repair

3M™ Automix™ E-Z Sand Rigid Parts Repair Kit

- A two-part structural adhesive and filler designed to bond and fill SMC, fiberglass reinforced plastics and other rigid plastic parts.
- To be used when attaching bonding strips and making cosmetic repairs.



Part Number	Container Size	Kits Per Case
051131-05883	5 oz. Tube/Kit	6

3M™ Automix™ Polyolefin Adhesion Promoter

- A specially designed adhesion promoter to be used with 3M™ Automix™ E-Z Sand Flexible Parts Repair (PNs 05895 and 05896) for the repair of Polypropylene and Ethylene Propylene interior and exterior parts, usually designated by the initials PP, EP, TPO or EPDM.



Part Number	Net Wt.	Containers Per Case
051131-05907	12 oz. Aerosol	6

3M™ Automix™ E-Z Sand Flexible Parts Repair Kits

- Can be used to repair most of the plastic parts found on today's vehicles.
- Very easy to sand.
- Excellent featheredging properties.
- Dispensed effortlessly from the tubes and mixes easily and completely.
- Syringe offers automatic metering of Parts A and B and the option to use the mixing nozzle for automatic mixing.



Part Number	Container Size	Kits Per Case
051131-05895	2-5 oz. Tubes/Kit	6
051131-05896	2-13 oz. Tubes/Kit	6

Adhesive Products

3M™ Super Weatherstrip Adhesive

- Bonds all types of gaskets to painted or unpainted metal surfaces.
- Adhesive stays permanently flexible and rubbery, never dries out or becomes hard.
- Easy to brush and spread.
- Extremely fast-drying.
- Exceptional bonding strength.
- Waterproof.
- Flexible (rubbery).
- Resists oil, grease and solvents.



Part Number	Container Size	Color	Tubes Per Case
051135-08001	5 oz. Tube	Yellow	6
051135-08002	2 oz. Tube	Yellow	12
051135-08008	5 oz. Tube	Black	6

3M™ Weatherstrip Adhesive Black

- Fast-drying black adhesive used for bonding and sealing weather stripping.
- Also an excellent adhesive for new EPDM weather stripping.
- Easy to apply.
- Remains flexible.
- Waterproof.



Part Number	Container Size	Tubes Per Case
051135-08011	5 oz. Tube	6

3M™ Fast Tack Trim Adhesive Light Amber

- Extremely fast drying light amber adhesive for bonding trim fabric.
- Especially good for adhering overhead trim, like headliners.
- Light, non-staining color.
- Gains high strength in seconds.
- Permits repositioning.
- Sticks to a variety of surfaces.
- Will not stain vinyl.



Part Number	Container Size	Tubes Per Case
051135-08031	5 oz. Tube	6

Adhesive Products

3M™ Top and Trim Adhesive Yellow

- Powerful yellow contact adhesive for bonding vinyl tops.
- Excellent for interior vinyl trim.
- Easily brushed or sprayed.
- No bleed through.
- Non-staining.
- Shipping weight is 38 lbs.



Part Number	Container Size	Pails Per Case
051135-08046	5 Gallon Pail	1

3M™ Ultrapro™ Trim and Emblem Adhesive Clear Gel

- Plastic top with brush applicator helps prevent lid from becoming attached to bottle.
- Easy application.
- Non-stringing.
- Excellent sag resistance.
- Fast-drying.
- Excellent initial holding strength.
- Will not harm cured paint.



Part Number	Net Wt.	Containers Per Case
051135-08063	8 fl. oz.	6

3M™ Feathering Disc Adhesive (Type 2)

- Especially formulated to allow multiple disc applications without adhesive buildup or paper delamination.
- Discs remove easily and cleanly.



Part Number	Container Size	Tubes Per Case
051135-08051	5 oz. Tube	6

3M™ Press-In-Place Emblem Adhesive

- Transfer adhesive allowing emblems with existing foam tape to be reattached.
- Non-stringing.
- No trimming needed.
- Press emblem onto adhesive, place emblem on vehicle.



Part Number	Size	Pieces Per Pack	Packs Per Case
051135-08069	2" x 12"	10	6

3M™ Spray Disc Adhesive

- A transparent, instant tack adhesive for bonding automotive feathering discs.
- Fan spray control.
- Instant tack.
- Many discs per adhesive application.
- Little pad buildup.



Part Number	Net Wt.	Cans Per Case
051135-08054	6 oz. Aerosol	6

3M™ Spray Trim Adhesive Clear

- An adhesive for attaching lightweight trim materials (upholstery cloth, trunk liners) to metal and other surfaces.
- Ideal for position-bonding applications where mechanical fasteners will be used.
- May be used to bond styrofoam.



Part Number	Container Size	Cans Per Case
051131-08074	24 fl. oz. Aerosol	6

3M™ Plastic and Emblem Adhesive Clear

- Excellent clear adhesive for plastic repair and emblem application.
- May be used for interior or exterior bonding.
- Used for bonding metal emblems, rigid plastic parts, taillight lenses and vinyl trim strips.
- Strong.
- Quick-drying.
- One surface application.



Part Number	Container Size	Tubes Per Case
051135-08061	5 oz. Tube	6

3M™ General Trim Adhesive Clear

- A low VOC, high-strength adhesive for bonding automotive materials (carpeting, jute pads, fabrics, plastics) to metal and other surfaces.
- Good heat and water resistance.
- Not recommended for bonding polystyrene foam. (For bonding polystyrene foam, use 3M™ Spray Trim Adhesive PN08074).



Part Number	Net Wt.	Cans Per Case
051135-08088	16.25 oz. Aerosol	6

Adhesive Products

3M™ Super Trim Adhesive Yellow

- A contact adhesive designed for bonding vinyl tops, heavyweight headliners and hood silencer pads where high strength and heat resistance are needed.



Part Number	Net Wt.	Cans Per Case
051135-08090	18 oz. Aerosol	6

3M™ Structural Adhesive Kit

- Two-part general purpose gray structural adhesive that may be used for bonding metal, glass and plastic.
- May be used for trim, fiberglass and flexible body parts repair.
- Easy mixing.
- Sets up quickly.
- Spreads smoothly.
- Cures to an extremely strong bond.



Part Number	Color	Container Size	Kits Per Case
051135-08101	Gray	2 — 2 fl. oz./Kit	6

3M™ Quick Fix Adhesive (Cyanoacrylate)

- Strong, rapid bonding, convenient to use adhesive.
- Good adhesion to rubber weather stripping, vinyl, metal, glass, side moldings, emblems, trim pieces and most plastics.
- Excellent resistance to temperature extremes, shock (such as slamming a door) and most automotive fluids.



Part Number	Size	Bottles Per Case
051135-08155	1 oz. Bottle	12

3M™ General Purpose Adhesive Cleaner

- Specially blended solvent.
- Provides easy cleanup of most types of adhesives.
- Quickly removes waxes, road tars, grease, oil and similar materials.
- Will not harm most thoroughly cured automotive paint, vinyl or fabrics when properly used.



Part Number	Container Size	Containers Per Case
051135-08984	1 Quart Can	6
051135-08986	5 Gallon Pail	1
051135-08987	15 oz. Aerosol Can	12

3M™ Fastbond™ Contact Adhesive 30-NF

- A water dispersed, high-strength clear contact adhesive.
- High coverage, a long bonding range, good heat resistance.
- Bonds canvas, plastic, plastic laminate and wood to themselves and to each other.

Part Number	Container Size	Containers Per Case
021200-21183	55 Gallon Drum	1 (Open Head)

3M™ Super 77™ Spray Adhesive

- Fast, aggressive tack for bonding most lightweight materials.
- An extremely versatile clear adhesive.



Part Number	Net Wt.	Cans Per Case
021200-21210	16.7 oz.	12

3M Sealants Application Guide

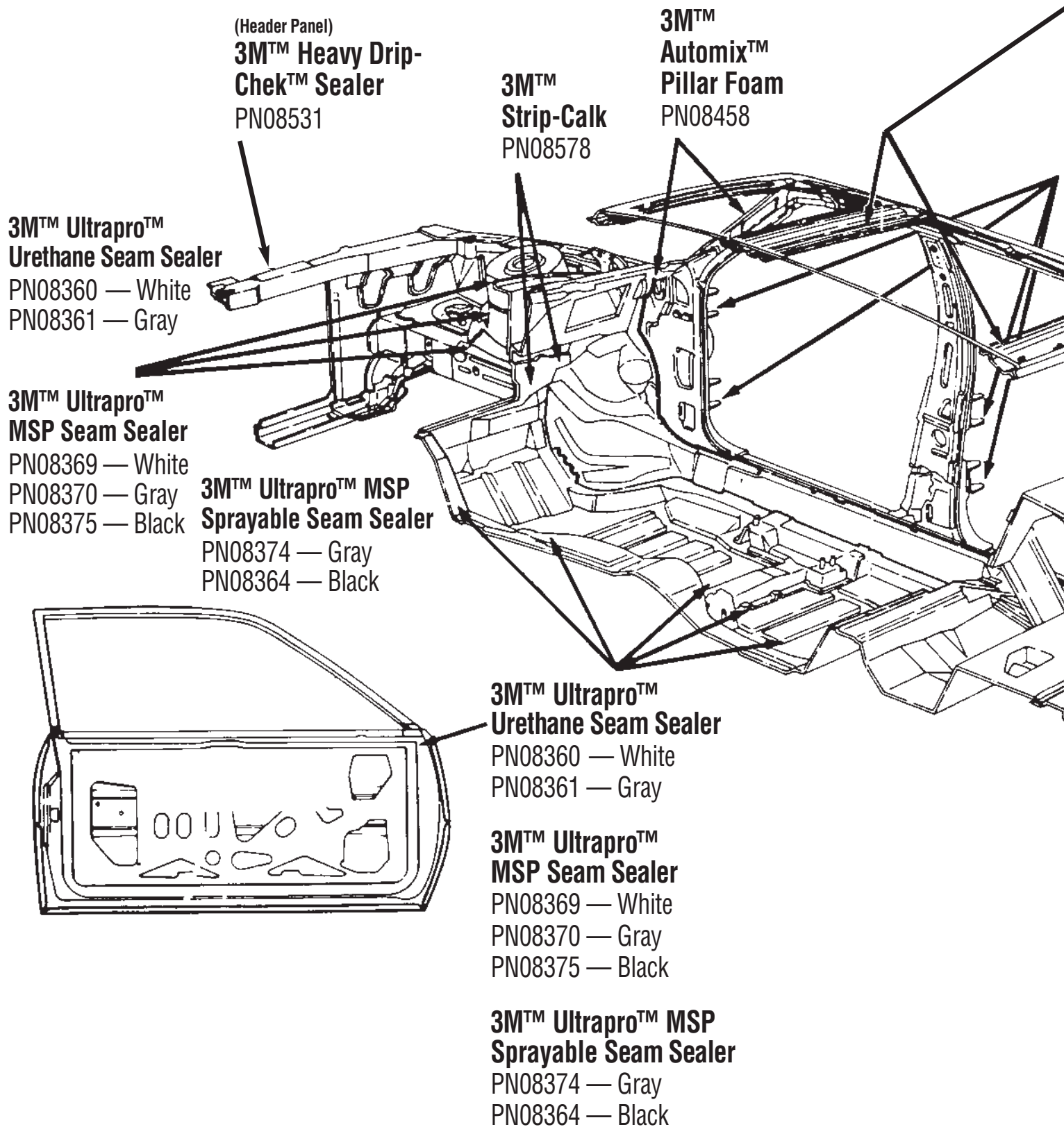

**3M™ Ultrapro™
Urethane Seam
Sealer**
PN08360 — White
PN08361 — Gray

**3M™ Ultrapro™
MSP Seam Sealer**
PN08369 — White
PN08370 — Gray
PN08375 — Black

**3M™ Ultrapro™
MSP Sprayable
Seam Sealer**
PN08374 — Gray
PN08364 — Black

3M™ Heavy Drip-Chek™ Sealer
PN08531

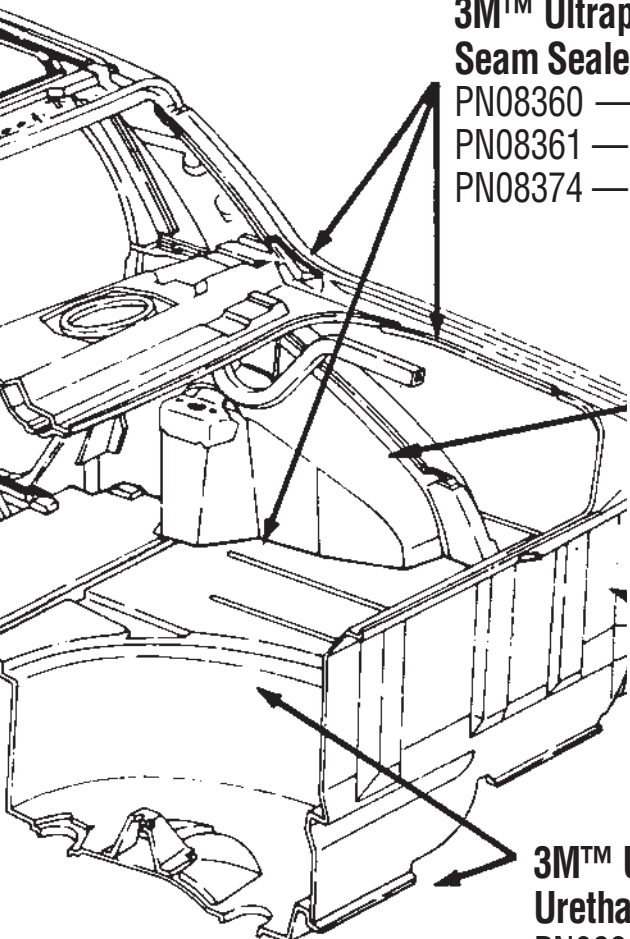

**3M™ Ultrapro™ Urethane
Seam Sealer**
PN08360 — White
PN08361 — Gray
PN08374 — Sprayable
Seam Sealer

**3M™ Automix™
Flexible Foam**
PN08463

(Taillight Extensions)
**3M™ Heavy
Drip-Chek™
Sealer**
PN08531

**3M™ Ultrapro™
Urethane Seam Sealer**
PN08360 — White
PN08361 — Gray

**3M™ Ultrapro™ MSP
Sprayable Seam Sealer**
PN08374 — Gray
PN08364 — Black

Basic Seam Sealers

- 3M™ Ultrapro™ MSP Seam Sealer**
(PN08369 — White)
(PN08370 — Gray)
(PN08375 — Black)
 - provides a fast method of seam sealing
 - non-shrinking, non-cracking
 - fast curing
 - tack-free = 30 minutes
 - immediately paintable for up to 72 hours
- 3M™ Ultrapro™ Urethane Seam Sealer**
(PN08360 — White 6/case)
(PN08361 — Gray 6/case)
 - easy to tool
 - stays flexible
 - paintable in 30 minutes
 - non-shrinking
 - can be baked immediately after painting
 - can be used in hood flutter and door intrusion beam repairs
 - Ford Aerostar™ and Explorer™ roof ditch repairs
 - duplicates OEM sealers
 - fills large voids without cracking
 - can be brushed
 Use with **3M™ Flexible Package Applicator Gun**
(PN08398 1/case)
- 3M™ Ultrapro™ Autobody Sealant (cartridge)**
(PN08300 — Tan 12/case)
 - fast skin over
 - easy to tool
 - stays flexible
 - paintable in 30 minutes
 Also available in: 5 oz. tube PN08301 — Tan (6/case)
5 oz. tube PN08302 — Clear (6/case)
Use with **3M™ Heavy-Duty Caulk Gun** (PN08995 1/case)
- 3M™ Heavy Drip-Chek™ Sealer (5 oz. tube)**
(PN08531 — Gray 6/case)
 - designed to seal but not fill
 - controlled shrinkage
 - retains original look on OEM seams
 - resists oil and gas
 - paintable in 30 minutes
- 3M™ Strip-Calk (box of 60 — 1 ft. strips)**
(PN08578 — Black 12 boxes/case)
 - easy application
 - stays soft and flexible
 - fills large voids and holes
 - no waste or cleanup

Specialty Seam Sealers

- Sprayable Seam Sealer — **3M™ Ultrapro™ MSP Sprayable Seam Sealer Cartridge** (PN08374 — Gray 6/case, PN08364 — Black 6/case) — Use with **Sprayable Seam Sealer Applicator Gun** (PN08400 1/case)
- Fast Skinning — **3M™ Ultrapro™ Autobody Sealant Cartridge** (PN08300 — Tan 12/case)
5 oz. Tube (PN08301 — Tan 6/case)
- 3M™ Fast 'n Firm™ Seam Sealer Cartridge** (PN08505 — Beige 12/case)
- Latex/Water-Based — **3M™ All-Around Autobody Sealant Cartridge** (PN08500 — White 12/case)
- Clear/Thin Bodied — **3M™ Clear Auto Sealer**
5 oz. Tube (PN08551 — Clear 6/case)
- Clear/Heavy Bodied — **3M™ Flexiclear™ Body Seam Sealer Cartridge** (PN08405 — Clear 12/case)
3M™ Ultrapro™ Autobody Sealant
5 oz. Tube (PN08302 — Clear 6/case)
- Expandable Foam — **3M™ Automix™ Pillar Foam** (PN08458)
Use with **3M™ Automix™ Flexible Foam** (PN08463)
Use with **MixPac® Applicator Gun** (PN08117)

Sealers

3M™ Ultrapro™ Autobody Sealant

- Heavy bodied seam sealer.
- Quick-skinning, fast-curing, flexible sealer.
- Can be used wherever heavy bodied seam sealers are needed.
- High solids and low shrinkage.
- Ideal seam sealer where time and speed are important.
- Paintable in 40 minutes.



Part Number	Size	Color	Quantity Per Case
051135-08300	Fits 1/10 Gallon Cartridge Gun	Tan	12
051135-08301	5 oz. Tube	Tan	6
051135-08302	5 oz. Tube	Clear	6

3M™ Ultrapro™ Urethane Seam Sealer

- One-part moisture curing urethane seam sealer that can be painted.
- Non-shrinking, non-cracking.
- Able to fill large voids.



Part Number	Description	Color	Quantity Per Case
08360*	310ml Foil Pack	White	6
08361**	310ml Foil Pack	Gray	6

* UPC Number 051131-16830

** UPC Number 051131-16831

3M™ Ultrapro™ MSP Sprayable Seam Sealer

- A high-performance, general purpose seam sealer that can be caulked or sprayed.
- For use on door skins, hemming flanges, quarter panels, and floor and trunk pans.
- Non-shrinking, non-cracking.
- Fast curing.
- Immediately paintable.
- Extra applicator tips supplied with sealer.
- Use with Sprayable Seam Sealer Applicator Gun (PN08400).
- May also be used as a coarse textured sound deadener for undercarriages.



Part Number	Container Size	Color	Cartridges Per Case
051135-08374	Fits 1/10 Gallon Cartridge Gun	Gray	6

3M™ Ultrapro™ MSP Seam Sealer

- A high-quality, heavy bodied, general purpose, moisture curing seam sealer.
- Designed for interior and exterior body joints.
- May be primed or painted immediately or up to 72 hours after application.
- After 72 hours, scuff sealant with Scotch-Brite™ General Purpose Hand Pad (Ultra Fine — PN07448) to improve paint adhesion.
- Not for use on lacquer paints.



Part Number	Color	Container Size	Containers Per Case
051135-08369	White	310ml Flex Pack	6
051135-08370	Gray	310ml Flex Pack	6

3M™ Flexiclear™ Body Seam Sealer

- High solids, clear joint and seam sealer designed to seal interior and exterior joints and seams.
- Adheres to primed metal and painted surfaces.
- Clear, non-yellowing.
- Excellent tooling properties.
- Can be painted quickly.
- Remains flexible.



Part Number	Container Size	Cartridges Per Case
051135-08405	Fits 1/10 Gallon Cartridge Gun	12

3M™ Seam Sealer Tape

- Used to seal hem flanges, door jambs and deck lid applications.
- Duplicates factory appearance.
- Immediately paintable.
- Requires no heat gun.
- Solvent enhanced bond.
- Very conformable.



Part Number	Roll Size	Rolls Per Case
051135-08475	3/8" x 30' (9.5mm x 9.1m)	12
051135-08476	7/8" x 30' (22.5mm x 9.1m)	12

3M™ All-Around Autobody Sealant White

- Used for sealing interior and exterior auto body joints and seams.
- Applies easily, can be smoothed to a featheredge with a wet finger and sets to a firm, tough, rubber-like, water-resistant bead.
- Can be painted within 30 minutes.
- Water cleanup (before it dries).
- Will not harm paint.



Part Number	Description	Quantity Per Case
051135-08500	Fits 1/10 Gallon Cartridge Gun	12

3M™ Fast'n Firm™ Seam Sealer Beige

- Firm setting product for sealing interior and exterior joints.
- Adheres to primed metal and painted surfaces.
- Skins over quickly.
- Low shrinkage.
- Can be painted within 20 minutes.
- Excellent tooling properties.
- Excellent sanding properties.



Part Number	Description	Quantity Per Case
051135-08505	Fits 1/10 Gallon Cartridge Gun	12

Sealers

3M™ Auto Bedding and Glazing Compound Black

- Non-hardening, pliable, water-resistant, medium-bodied sealer for sealing auto seams and between windshield rubber and car body.
- Can be used as a supplementary sealer for auto glass installation.
- Remains permanently soft.
- Has non-sag consistency for vertical and overhead applications.
- Cleans up with dry rag.



Part Number	Container Size	Cartridges Per Case
051135-08509	Fits 1/10 Gallon Cartridge Gun	12

3M™ Heavy Drip-Chek™ Sealer Gray

- Heavy-based sealer especially designed for use on vertical seams.
- Heavier bodied consistency.
- Up to 1/8" bead can be applied easily.
- Weathers well — does not crack or deteriorate in sunlight.
- Excellent adhesion to metal, paint, glass, rubber, etc.
- Resists gas and oil.



Part Number	Container Size	Tubes Per Case
051135-08531	5 oz. Tube	6

3M™ Clear Auto Sealer

- Used for sealing leaks in windshields, backlites, reveal moldings, truck ornaments, taillights and other small seams on the auto body.
- Flexible and color stable.
- May be water tested soon after application.
- Will not harden or become brittle.
- Dries to smooth, bubble-free film.



Part Number	Container Size	Tubes Per Case
051135-08551	5 oz. Tube	6

3M™ Strip-Calk Black

- Soft, non-hardening caulking material in one-foot lengths for use in all types of seams, joints and openings.
- Easily thumbed into place and smoothed with finger.
- May be painted immediately.
- Has non-sag consistency for vertical and overhead applications.
- Non-shrinking.
- Adheres to metal, paint, glass and rubber.
- Completely waterproof.
- Will not crack or dry out.



Part Number	Container Size	Boxes Per Case
051135-08578	Box of 60 1' Lengths	12

3M™ Brushable Seam Sealer Gray

- Specially developed to seal sheet metal overlap joints that have been spot welded riveted or bolted together.
- Dries quickly without sag or flow to restore factory appearance.
- Can be painted when dry.
- Adheres to primed or painted surfaces.
- Remains flexible and resists oil, fuel and other automotive fluids.
- Use for sealing floor pans, firewalls, trunk seams, shock absorber mounting towers around wheelwells, fuel filler splash pans and around headlight and taillight openings.



Part Number	Container Size	Quarts Per Case
051135-08656	1 Quart	6

3M™ Super Silicone Sealant

- Rapid-curing adhesive/sealant formulated to solve repair and maintenance problems.
- Excellent gasket adhesive and form-in-place gasket material.
- Adheres to a wide variety of automotive surfaces.



Part Number	Color	Container Size	Quantity Per Case
Boxed			
051135-08661	Clear	3 oz. Tube	12
051135-08662	Black	3 oz. Tube	12

Cartridges

051135-08663	Clear	Fits 1/10 Gallon Cartridge Gun	12
051135-08664	Black	Fits 1/10 Gallon Cartridge Gun	12

3M™ Ultrapro™ High Temp Silicone Gasket

- Premium grade compound for form-in-place gasketing.
- Range from -20°F to 600°F intermittent.
- Oxygen sensor safe.



Part Number	Color	Container Size	Tubes Per Case
051135-08672	Black	3 fl. oz. Tube	6

3M Coatings Application Guide

FIREWALL

- 08864** 3M™ Body Schutz™ Coating Black
- 08881** 3M™ Undercoating Black
- 08883** 3M™ Underseal™ Rubberized Undercoating Black
- 08804** 3M™ No Cleanup Water-Based Undercoating
- 08949** 3M™ No Cleanup Rocker Gard™ Coating Tan
- 08964** 3M™ No Cleanup High Coverage Body Schutz™ Coating Black

FLOOR PANS

- 08881** 3M™ Undercoating Black
- 08883** 3M™ Underseal™ Rubberized Undercoating Black
- 08804** 3M™ No Cleanup Water-Based Undercoating
- 08964** 3M™ No Cleanup High Coverage Body Schutz™ Coating Black

ROCKER PANELS

- 05910** 3M™ Rocker Panel Spray Tan
- 05911** 3M™ Rocker Panel Spray Clear
- 08874** 3M™ Rocker Schutz™ Coating Beige
- 08949** 3M™ No Cleanup Rocker Gard™ Coating Tan

WHEEL WELLS

- 08864** 3M™ Body Schutz™ Coating Black
- 08881** 3M™ Undercoating Black
- 08883** 3M™ Underseal™ Rubberized Undercoating Black
- 08804** 3M™ No Cleanup Water-Based Undercoating
- 08949** 3M™ No Cleanup Rocker Gard™ Coating Tan
- 08964** 3M™ No Cleanup High Coverage Body Schutz™ Coating Black

UNDERCARRIAGE

- 08864** 3M™ Body Schutz™ Coating Black
- 08881** 3M™ Undercoating Black
- 08883** 3M™ Underseal™ Rubberized Undercoating Black
- 08804** 3M™ No Cleanup Water-Based Undercoating
- 08964** 3M™ No Cleanup High Coverage Body Schutz™ Coating Black

ROCKER PANELS

- 05910** 3M™ Rocker Panel Spray Tan
- 05911** 3M™ Rocker Panel Spray Clear
- 08874** 3M™ Rocker Schutz™ Coating Beige
- 08949** 3M™ No Cleanup Rocker Gard™ Coating Tan

UNDERCARRIAGE

- 08864** 3M™ Body Schutz™ Coating Black
- 08881** 3M™ Undercoating Black
- 08883** 3M™ Underseal™ Rubberized Undercoating Black
- 08804** 3M™ No Cleanup Water-Based Undercoating
- 08964** 3M™ No Cleanup High Coverage Body Schutz™ Coating Black

INSIDE DOOR SKINS

- 08881** 3M™ Undercoating Black
- 08883** 3M™ Underseal™ Rubberized Undercoating Black
- 08804** 3M™ No Cleanup Water-Based Undercoating
- 08891, 08892** 3M™ Rust Fighter-I Amber
- 08964** 3M™ No Cleanup High Coverage Body Schutz™ Coating Black

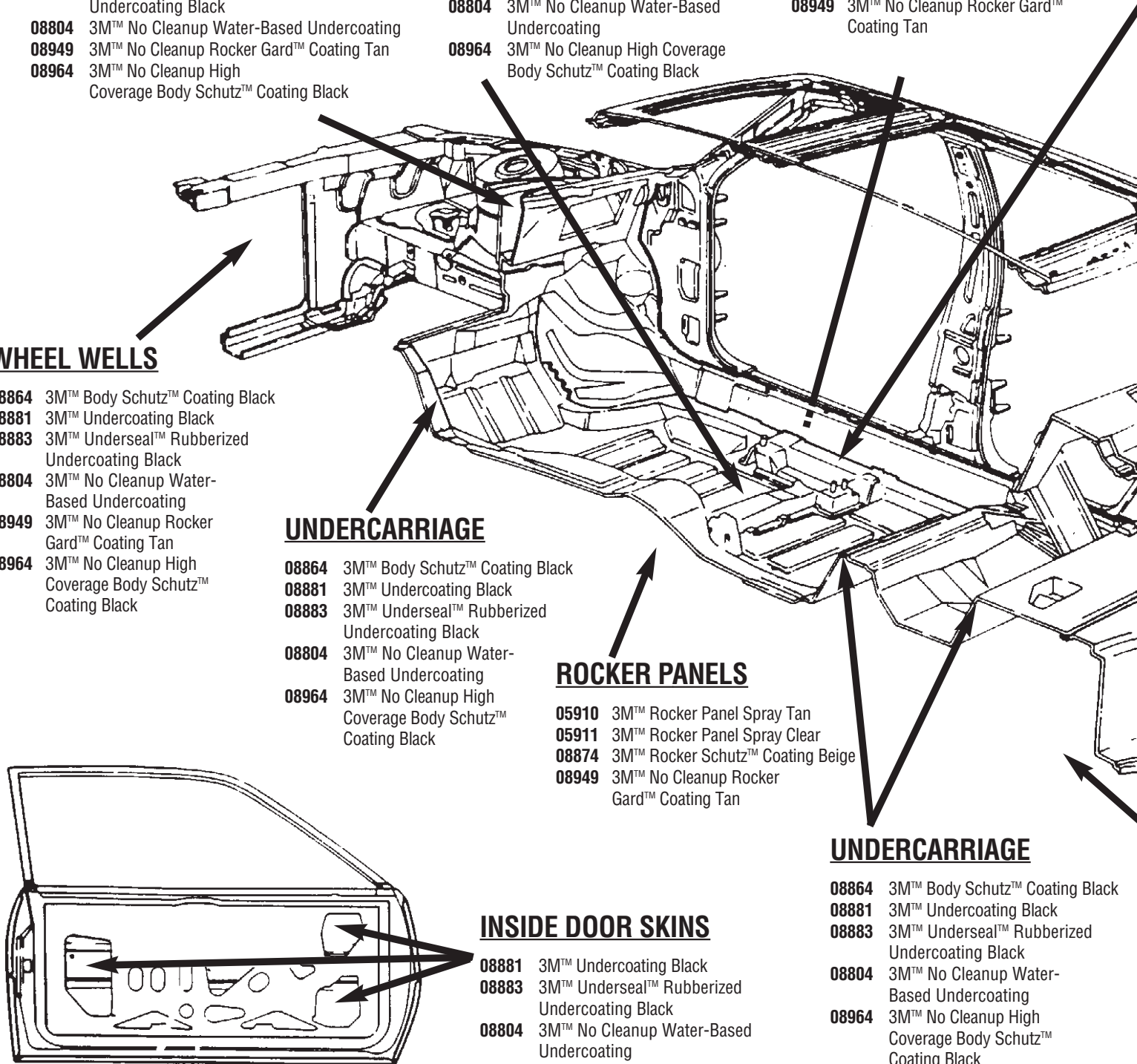

FOR CORROSION PROTECTION, SOUND DEADENING AND STONE CHIP PROTECTION

FRAME RAILS

Interior

- 08891, 08892** 3M™ Rust Fighter-I Amber

Exterior

- 08864** 3M™ Body Schutz™ Coating Black
08804 3M™ No Cleanup Water-Based Undercoating
08964 3M™ No Cleanup High Coverage Body Schutz™ Coating Black

WHEEL WELLS

- 08864** 3M™ Body Schutz™ Coating Black
08881 3M™ Undercoating Black
08883 3M™ Underseal™ Rubberized Undercoating Black
08804 3M™ No Cleanup Water-Based Undercoating
08949 3M™ No Cleanup Rocker Gard™ Coating Tan
08964 3M™ No Cleanup High Coverage Body Schutz™ Coating Black

TRUNK AREAS

- 08864** 3M™ Body Schutz™ Coating Black
08881 3M™ Undercoating Black
08883 3M™ Underseal™ Rubberized Undercoating Black
08804 3M™ No Cleanup Water-Based Undercoating
08949 3M™ No Cleanup Rocker Gard™ Coating Tan
08964 3M™ No Cleanup High Coverage Body Schutz™ Coating Black

TRUNK

- 08864** 3M™ Body Schutz™ Coating Black
08881 3M™ Undercoating Black
08883 3M™ Underseal™ Rubberized Undercoating Black
08804 3M™ No Cleanup Water-Based Undercoating
08949 3M™ No Cleanup Rocker Gard™ Coating Tan
08964 3M™ No Cleanup High Coverage Body Schutz™ Coating Black

WHEEL WELLS

- 08864** 3M™ Body Schutz™ Coating Black
08881 3M™ Undercoating Black
08883 3M™ Underseal™ Rubberized Undercoating Black
08804 3M™ No Cleanup Water-Based Undercoating
08949 3M™ No Cleanup Rocker Gard™ Coating Tan
08964 3M™ No Cleanup High Coverage Body Schutz™ Coating Black

UNDERCOATING AND RUST PREVENTION

INTERIOR CORROSION PROTECTION

- * **08891, 08892** 3M™ Rust Fighter-I Amber (6/case)
• aerosol

PAINTABLE MULTI-PURPOSE COATINGS

- † **08804** 3M™ No Cleanup Water-Based Undercoating (6/case)
• low voc
• high solids/water cleanup
- ** **08864** 3M™ Body Schutz™ Coating Black (6/case)
• smooth to medium finish
- 08881** 3M™ Undercoating Black (6/case)
• aerosol
- 08883** 3M™ Underseal™ Rubberized Undercoating Black (6/case)
• aerosol
- † **08949** 3M™ No Cleanup Rocker Gard™ Coating Tan (6/case)
• smooth to medium finish
- † **08964** 3M™ No Cleanup High Coverage Body Schutz™ Coating Black (6/case)
• smooth to medium finish

ROCKER PANELS, VALANCES, STONE CHIP AREAS

- 05910** 3M™ Rocker Panel Spray Tan (6/case)
• aerosol
• coarse to fine textures
- 05911** 3M™ Rocker Panel Spray Clear (6/case)
• aerosol
• medium to smooth textures
- ** **08874** 3M™ Rocker Schutz™ Coating Beige (6/case)
• medium to coarse finish
- † **08949** 3M™ No Cleanup Rocker Gard™ Coating Tan (6/case)
• smooth to medium finish

- † Use with 3M™ No Cleanup Applicator Gun (PN08801)
* Use with 3M™ Rust Fighter-I Application Wand (PN08998)
** Use with 3M™ Body Schutz™ Applicator Gun (PN08997)

Coatings

3M™ Rocker Panel Spray Tan

- A paintable coating.
- Specially formulated to match the coarse-to-fine texture of factory-applied textured coating on the stone-throw areas of automobiles.



Part Number	Net Wt.	Cans Per Case
051131-05910	18 oz. Aerosol	12

3M™ Rocker Panel Spray Clear

- Designed for application over acrylic lacquer top coats or under any refinish paint system.
- This coating is specially formulated to match the medium-to-smooth textured coatings on the stone-throw areas of late model automobiles.



Part Number	Net Wt.	Cans Per Case
051131-05911	18 oz. Aerosol	12

3M™ No Cleanup Water-Based Undercoating Black

- A tough, rubberized, paintable, water-based undercoating for corrosion protection and sound deadening.
- High solids for excellent coverage.
- Designed for use on automotive undercarriages, door skins, wheel wells, trunks and floor pans.
- Easily applied with 3M™ No Cleanup Applicator Gun (PN08801).



Part Number	Container Size	Quantity Per Case
051135-08804	20 oz. Can	6

3M™ Body Schutz™ Rubberized Coating Black

- Rubberized, protective coating developed primarily for use as a sound deadener, protective coating and underseal.
- Excellent adhesion to a variety of surfaces.
- Dries extremely rapidly.
- High resistance to abrasion and wear.
- Rapidly and easily applied with 3M™ Applicator Gun (PN08997).
- Convenient and portable system.

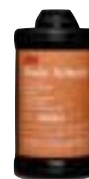

Part Number	Container Size	Quarts Per Case
051135-08864	1 Quart Can	6

3M™ Rocker Schutz™ Beige

- A fast-drying, paintable, chip-resistant coating for use on motor vehicles that resist weathering, salt spray and abrasion.
- Paintable 30 minutes after application.
- Apply with our 3M™ Body Schutz™ Applicator Gun (PN08997).



Part Number	Net Wt.	Quantity Per Case
051135-08874	16.5 oz.	6

3M™ Undercoating Black

- A multi-purpose, non-paintable aerosol coating for under carriages, wheel wells, frame rails and fenders.
- Designed to protect metal from corrosion and abrasion.
- Can also be used as a sound-dampening coating in door skins.



Part Number	Net Wt.	Cans Per Case
051135-08881*	16 oz. Aerosol	6

*Not for sale in California.

3M™ Underseal™ Rubberized Undercoating Black

- Rapid-drying, rubberized undercoating material in an aerosol container.
- For rustproofing and sound deadening, also for sealing fenders, quarter panels, door panels, repaired sections, welded joints, hoods and decks.
- Sprays easier than other products.
- Maintains proper spray pattern while applying and won't plug the spray nozzle.
- Quick-drying.
- Sound deadening.



Part Number	Net Wt.	Cans Per Case
051131-08883*	19.75 oz. Aerosol	6

*Not for sale in California.

Coatings

3M™ Underseal™ Undercoating 40

- A 40% VOC Aerosol rubberized undercoating designed to protect surfaces from corrosion and to provide sound deadening.
- Solvent blend reduced to comply with 40% VOC requirements.
- Good coverage and sprayability.
- Can be applied to bare or primed metal.
- Provides sound deadening to sheet metal.
- Good corrosion protection.



Part Number	Net Wt.	Cans Per Case
051131- 38883*	24 oz. Aerosol	6

*For sale in California only.

3M™ No Cleanup Rocker Gard™ Coating Tan

- A paintable within one hour rocker panel coating.
- Exhibits a medium-to-fine texture.
- Has a tack-free time of ten minutes.
- Can be used wherever stone chip protection is needed.
- To be used with the 3M™ No Cleanup Applicator Gun (PN08801).



Part Number	Container Size	Cans Per Case
051135- 08949	24 oz. Can	6

3M™ Rust Fighter-I Amber (Internal Coating Compound)

- Non-hardening compound.
- Designed to coat inner body panels and other metal parts.
- Replaces protection which is applied at factory and destroyed in repair procedures.
- Low odor level permits use indoors.
- Easily applied with 3M™ Rust Fighter-I Application Wand (PN08998).



Part Number	Container Size	Containers Per Case
051135- 08891	1 Quart	6

Part Number	Net Wt.	Cans Per Case
051135- 08892	18.75 oz. Aerosol	6

3M™ No Cleanup High Coverage Body Schutz™ Coating Black

- A product that exhibits greater coverage, better environmental protection and is more durable than other similar coatings.
- One 24-ounce can covers up to 43% more than conventional 32-ounce coatings.
- Its no cleanup applicator system provides the added benefits of no mess, no clogged guns and absolutely no cleanup.
- It's ready to use every time you are.
- Use with 3M™ No Cleanup Applicator Gun (PN08801).



Part Number	Container Size	Cans Per Case
051135- 08964	24 oz. Can	6

3M™ Rust Fighter-I Application Wand

- Developed to provide a reusable, inexpensive means of applying 3M™ Rust Fighter-I (quarts) into hard-to-reach areas.
- 36" tubing is flexible but has memory to allow easy access to enclosed areas.
- Patented tip provides a 360° to 180° spray pattern.
- Requires no cleanup when used with 3M™ Rust Fighter-I (PN08891).



Part Number	Quantity Per Case
051135- 08998	12

3M™ No Cleanup Replacement Nozzles

- Designed for use with 3M™ No Cleanup Coatings PNs 08804, 08949, and 08964.



Part Number	Quantity Per Bag	Bags Per Case
051135- 08966	8	4

Retail Adhesives, Coatings and Sealers Products

3M™ Plastic Emblem & Trim Adhesive

- Ideal for bonding and minor repairs on vinyl molding, interior trim, plastic and metal ornaments.
- Interior or exterior use.
- Resistant to water, heat and fuels.
- Dries quickly.



Part Number	Container Size	Tubes Per Case
051131- 03601	30ml/1 fl. oz. Tube	12

3M™ Adhesive & Wax Remover

- Quickly removes wax and adhesive residue.
- Will not harm most cured automotive paints.
- Also suitable for vinyl and glass surfaces.



Part Number	Container Size	Cans Per Case
051131- 03607	8 fl. oz. Can	6
051131- 03618	12 oz. Aerosol	6

3M™ Black Super Weatherstrip Adhesive

- Bonds gaskets and weather stripping to metal surfaces.
- Strong, flexible bond.
- Withstands vibration and temperature changes.
- Resists oils, fuels, detergents and grease.

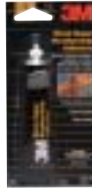

Part Number	Container Size	Tubes Per Case
051131- 03602	30ml/1 fl. oz. Tube	12

Auto Glass Installation



Products

Applicator Guns and Accessories	175–176
Glass Cleaners	174
Glass Primers	171
Glass Sealants	174
Glass Shop Belts	173
Ribbon Sealers	173
Urethane Primers	171
Windshield Adhesives, Urethanes	171–172

Auto Glass Installation



3M™ Auto Glass Replacement Instructions

The windshield . . . a structural member of today's automobile.

In the early 1980's auto makers responded to skyrocketing fuel prices by reducing vehicle weights and increasing vehicle aerodynamics. Flush-mounted glass and the windshield becoming a structural part of the vehicle were results of this effort.

As the windshield became a designed safety feature of the vehicle, windshield replacement technology changed quickly and corresponding regulations emerged. Department of Transportation regulations 212 and 216 set standards for windshield retention and roof crush during rollover. And, with the windshield a designed safety feature, glass shops had to consider specific regulations such as the Motor Vehicle Safety Act (see below). Glass shops were now responsible for replacing the glass to meet OEM specifications.

Motor Vehicle Safety Act-Section 1397 (a) (2) (a)

"No. . . dealer. . . repair business shall knowingly render inoperative, in whole or in part, any device or element of design installed on or in a motor vehicle. . . unless. . . such. . . vehicle. . . will not be used. . . during the time such device or element or design is rendered inoperative."

3M is an innovator in the development of windshield replacement products and methods.

3M has provided products to the automotive industry for glass installation the past 40 years.

3M™ Auto Glass Replacement Instructions

These instructions describe the proper use of 3M Auto Glass Urethanes and related 3M Glass Shop products and are intended for use as a supplement to detailed service manuals and instructions provided by automotive manufacturers. Automobile manufacturer instructions should be followed when removing automotive trim and moldings as well as other special requirements pertaining to specific car models.

NOTE: The products and procedures presented here may be applicable to quarter glass and backlite replacements. However, for detailed instructions by car model, you should refer to information available from the automobile manufacturer.

Full Cutout Method With Dam Materials Using 3M™ Auto Glass Urethane Windshield Adhesive — Medium Viscosity (PNs 08693, 08695 or 08564)

The following instructions cover replacement procedure for urethane bonded automotive windshields using the full cut out procedure with dam material. The dam material provides the proper setting height.

1. Organize all tools, product and equipment needed. Wear appropriate safety equipment, such as Nitrile rubber, Butyl rubber, chemical resistant gloves, safety glasses, apron or other protective equipment required by safety or company regulations.
2. If necessary, remove windshield wiper arms and trim, as necessary, to expose the entire perimeter of glass.
3. Clean dirt and debris from around the pinchweld area before cutting out the glass and again after the glass is cut out to minimize contamination.
4. Cut into existing urethane around entire perimeter of glass with a utility knife cutting as close to edge of the glass as possible.
5. Cut out glass with appropriate removal tools keeping as close to the glass as possible. Remove windshield and repeat Step 3.
6. Dry set the glass. Align for uniform fit and adjust setting blocks as needed for best fit. To allow for sufficient bonding of urethane, make sure there is a MINIMUM of 1/4-inch of glass, in addition to the space that will be taken up by any dam material, around the entire perimeter of the glass. Mark location by applying masking tape to windshield and car body. Slit tape at edge of glass. Remove windshield.
7. Remove major portion of old urethane adhesive from the pinchweld. Use a razor blade knife or utility knife to prevent scraping paint off the pinchweld and exposing bare metal. **NOTE:** On urethane installations, it is recommended that a thin film (1–2 mm) of the old urethane be left on the pinchweld and fresh urethane is bonded to remaining film. **When removing butyl tape or unknown material, remove all old material from pinchweld.**
8. Prime any bare metal scratches with 3M™ Single Step Primer, (PN08681). **NOTE:** When excessive abrasive cleaning is required, prime pinchweld metal with a two-part epoxy automotive paint primer and allow to cure properly. Apply 3M™ Black Primer (Step 2) to repaired area and allow to dry for at least 5 minutes.
9. Preparing the glass.
Single Step Primer:
 - a. Clean inside surface of glass with 3M™ Glass Cleaner (PN08888) and a lint-free paper towel to clean the surface where the urethane bond will be made.

- b. Verify the primer and urethane are within use by dates.
- c. Shake 3M™ Single Step Primer (PN08681) for at least 30 seconds before application.
- d. Apply 3M™ Single Step Primer (PN08681) to the outer edge of the glass where the urethane bond will be made and allow to dry for at least 10 minutes.

Two Primer System:

- a. Clean inside surface of glass with 3M™ Glass Cleaner (PN08888) and a lint-free paper towel to clean the surface where the urethane bond will be made.
 - b. Verify the primers and urethane are within use by dates.
 - c. Apply a thin film of 3M™ Clear Primer (Step 1), (PNs 08683, 08685 or 08691) to the outer edge of the glass where the urethane bond will be made with a clean unused dauber. Wipe off excess primer while still wet with a clean lint free paper towel. Allow primer to dry for at least 5 minutes. (Repeat this step for a total of two applications).
 - d. Apply 3M™ Black Primer (Step 2), (PN08692) over the primed area of the glass. Allow primer to dry for at least 5 minutes.
10. If a foam dam was used in the OEM application, it is suggested that foam dam material should be replaced. If no jamb was used, it is suggested that 3M™ Foam Spacer Blocks (PN08529) be applied to the inside edge of the pinchweld to assist in setting the glass when using 3M™ Auto Glass Urethane Windshield Adhesive—Medium Viscosity.
 11. Cut tip to desired shape and size to provide a bead height sufficient to give good contact with the windshield around the entire perimeter. A triangular shaped notch will provide the desired bead shape and height. A height of 1/2 to 9/16-inch and a 1/4 to 5/16-inch base is suggested. **NOTE:** Where installing encapsulated glass, apply a bead high enough to assure glass contact before encapsulation contacts the car body and prevents further setting. Back padding material after setting will not be possible.
 12. Apply 3M™ Auto Glass Urethane Windshield Adhesive—Medium Viscosity directly onto the OEM urethane film on the pinchweld or directly to the glass.
 13. Position the glass by aligning the masking tape on glass and car body. Press glass in place to assure complete contact with the urethane adhesive.
 14. Paddle squeeze out around edge of glass if possible. If necessary, paddle additional adhesive between glass and car body to fill voids.
 15. Remove masking tape alignment strips.
 16. Replace moldings, windshield wipers and other trim removed in Step 1.
 17. Clean any excess urethane with an adhesive cleaner.

3M™ Auto Glass Replacement Instructions

Full Cut Method Without Dam Materials Using 3M™ Fast Cure Auto Glass Urethane — High Viscosity (PNs 08689, 08690 or 08566) or 3M™ Auto Glass Urethane Windshield Adhesive — High Viscosity (PNs 08696 or 08698)

The following instructions cover replacement procedure for urethane bonded automotive windshields using the full cut out procedure without the use of a dam material. High viscosity urethane products provide windshield support while the cure is attained to provide structural strength.

1. Organize all tools, product and equipment needed. Wear appropriate safety equipment, such as Nitrile rubber, Butyl rubber, chemical resistant gloves, safety glasses, apron or other protective equipment required by safety or company regulations.
2. If necessary, remove windshield wiper arms and trim necessary to expose the entire perimeter of glass.
3. Clean dirt and debris from around the pinchweld area before cutting out the glass and again after the glass is cut out to minimize contamination.
4. Cut into existing urethane around entire perimeter of glass with a utility knife cutting as close to edge of the glass as possible.
5. Cut out glass with appropriate removal tools keeping as close to the glass as possible. Remove windshield and repeat Step 3.
6. Dry set the glass. Align for uniform fit and adjust setting blocks as needed for best fit. To allow for sufficient bonding of urethane, make sure there is a MINIMUM of 1/4-inch of glass, in addition to the space that will be taken up by any dam material, around the entire perimeter of the glass. Mark location by applying masking tape to windshield and car body. Slit tape at edge of glass. Remove windshield.
7. Remove major portion of old urethane adhesive from the pinchweld. Use a razor blade knife or utility knife to prevent scraping paint off the pinchweld and exposing bare metal. **NOTE:** On urethane installations, it is recommended that a thin film (1–2 mm) of the old urethane be left on the pinchweld and fresh urethane is bonded to remaining film. **When removing butyl tape or unknown material, remove all old material from pinchweld.**
8. Prime any bare metal scratches with 3M™ Single Step Primer (PN08681). **NOTE:** When excessive abrasive cleaning is required, prime pinchweld metal with a 2 part epoxy automotive paint primer and allow to cure properly. Apply 3M™ Black Primer (Step 2) to repaired area and allow to dry for at least 5 minutes.
9. Preparing the glass.
Single Step Primer:
 - a. Clean inside surface of glass with 3M™ Glass Cleaner (PN08888) and a lint-free paper towel to clean the surface where the urethane bond will be made.
 - b. Verify the primer and urethane are within use by dates.
 - c. Shake 3M™ Single Step Primer (PN08681) for at least 30 seconds before application.
 - d. Apply 3M™ Single Step Primer (PN08681) to the outer edge of the glass where the urethane bond will be made and allow to dry for at least 10 minutes.Two Primer System:
 - a. Clean inside surface of glass with 3M™ Glass Cleaner (PN08888) and a lint-free paper towel to clean the surface where the urethane bond will be made.
 - b. Verify the primers and urethane are within use by dates.
 - c. Apply a thin film of 3M™ Clear Primer (Step 1) (PNs 08683, 08685 or 08691) to the outer edge of the glass where the urethane bond will be made with a clean unused dauber. Wipe off excess primer while still wet with a clean lint-free paper towel. Allow primer to dry for at least 5 minutes. (Repeat this step for a total of two applications).
 - d. Apply 3M™ Black Primer (Step 2) (PN08692) over the primed area of the glass. Allow primer to dry for at least 5 minutes.
10. If a foam dam was used in the OEM application it is suggested that foam dam material should be replaced.
11. Cut tip to desired shape and size to provide a bead height sufficient to give good contact with the windshield around the entire perimeter. A triangular shaped notch will provide the desired bead shape and height. A height of 1/2 to 9/16-inch and a 1/4 to 5/16-inch base is suggested. **NOTE:** Where installing encapsulated glass, apply a bead high enough to assure glass contact before encapsulation contacts the car body and prevents further setting. Back padding material after setting will not be possible.
12. Apply 3M™ Auto Glass Urethane Windshield Adhesive—High Viscosity or 3M™ Fast Cure Auto Glass Urethane—High Viscosity directly onto the OEM urethane film on the pinchweld or directly to the glass.
13. Position the glass by aligning the masking tape on glass and car body. Press glass in place to assure complete contact with the urethane adhesive.
14. Paddle squeeze out around edge of glass if possible. If necessary, paddle additional adhesive between glass and car body to fill voids.
15. Remove masking tape alignment strips.
16. Replace moldings, windshield wipers and other trim removed in Step 1.
17. Clean any excess urethane with an adhesive cleaner.

3M™ Auto Glass Replacement Instructions

Full Cut Method Using 3M™ Rapid Two-Part Urethane Adhesive (RTP) (PNs 08533, 08534)

The following instructions cover replacement procedure for urethane bonded automotive windshields using the full cut out procedure using 3M™ Rapid Two-Part Urethane.

1. Organize all tools, product and equipment needed. Wear appropriate safety equipment, such as Nitrile rubber, Butyl rubber, chemical resistant gloves, safety glasses, apron or other protective equipment required by safety or company regulations.
2. If necessary, remove windshield wiper arms and trim necessary to expose the entire perimeter of glass.
3. Clean dirt and debris from around the pinchweld area before cutting out the glass and again after the glass is cut out to minimize contamination.
4. Cut into existing urethane around entire perimeter of glass with a utility knife cutting as close to edge of the glass as possible.
5. Cut out glass with appropriate removal tools keeping as close to the glass as possible. Remove windshield and repeat Step 3.
6. Dry set the glass. Align for uniform fit and adjust setting blocks as needed for best fit. To allow for sufficient bonding of urethane, make sure there is a MINIMUM of 1/4-inch of glass, in addition to the space that will be taken up by any dam material, around the entire perimeter of the glass. Mark location by applying masking tape to windshield and car body. Slit tape at edge of glass. Remove windshield.
7. Remove major portion of old urethane adhesive from the pinchweld. Use a razor blade knife or utility knife to prevent scraping paint off the pinchweld and exposing bare metal. **NOTE:** On urethane installations, it is recommended that a thin film (1–2 mm) of the old urethane be left on the pinchweld and fresh urethane is bonded to remaining film. **When removing butyl tape or unknown material, remove all old material from pinchweld.**
8. Prime any bare metal scratches with 3M™ Single Step Primer (PN08681). **NOTE:** When excessive abrasive cleaning is required, prime pinchweld metal with a two-part epoxy automotive paint primer and allow to cure properly. Apply 3M™ Black Primer (Step 2) to repaired area and allow to dry for at least 5 minutes.
9. Preparing the glass.
Single Step Primer:
 - a. Clean inside surface of glass with 3M™ Glass Cleaner (PN08888) and a lint-free paper towel to clean the surface where the urethane bond will be made.
 - b. Verify the primer and urethane are within use by dates.
 - c. Shake 3M™ Single Step Primer (PN08681) for at least 30 seconds before application.
 - d. Apply 3M™ Single Step Primer (PN08681) to the outer edge of the glass where the urethane bond will be made and allow to dry for at least 10 minutes.Two Primer System:
 - a. Clean inside surface of glass with 3M™ Glass Cleaner (PN08888) and a lint-free paper towel to clean the surface where the urethane bond will be made.
 - b. Verify the primers and urethane are within use by dates.
 - c. Apply a thin film of 3M™ Clear Primer (Step 1), (PNs 08683, 08685 or 08691) to the outer edge of the glass where the urethane bond will be made with a clean unused dauber. Wipe off excess primer while still wet with a clean lint free paper towel. Allow primer to dry for at least 5 minutes. (Repeat this step for a total of two applications.)
 - d. Apply 3M™ Black Primer (Step 2), (PN08692) over the primed area of the glass. Allow primer to dry for at least 5 minutes.
10. If a foam dam was used in the OEM application it is suggested that foam dam material should be replaced. If no jamb was used, it is suggested that 3M™ Foam Spacer Blocks (PN08529) be applied to the inside edge of the pinchweld to assist in setting the glass when using 3M™ Rapid Two Part Urethane Adhesive.
11. Cut tip to desired shape and size to provide a bead height sufficient to give good contact with the windshield around the entire perimeter. A triangular shaped notch will provide the desired bead shape and height. A height of 1/2 to 9/16-inch and a 1/4 to 5/16-inch base is suggested. **NOTE:** Where installing encapsulated glass, apply a bead high enough to assure glass contact before encapsulation contacts the car body and prevents further setting. Back paddling material after setting will not be possible.
12. Apply 3M™ Rapid Two-Part Urethane Adhesive directly onto the OEM urethane film on the pinchweld or directly to the glass.
13. Position the glass by aligning the masking tape on glass and car body. Press glass in place to assure complete contact with the urethane adhesive.
14. Paddle squeeze out around edge of glass if possible. If necessary, paddle additional adhesive between glass and car body to fill voids.
15. Remove masking tape alignment strips.
16. Replace moldings, windshield wipers and other trim removed in Step 1.
17. Clean any excess urethane with an adhesive cleaner.

Auto Glass Primers

3M™ Single Step Primer

- Used to prime automotive windshields to promote urethane adhesion to the windshield.
- Can be used to prime encapsulated glass and to touch up scratches on pinchwelds.
- Meets OEM testing requirements.



Part Number	Size	Quantity Per Case
051135-08681	125ml	6

3M™ Clear Primer (Step 1)

- A clear, fast-drying product designed to clean and prime the edge of windshields prior to bonding with 3M™ Urethane Windshield Adhesives.
- Will clean the surface of glass and improve the adhesion properties of 3M™ Urethane Windshield Adhesives.



Part Number	Size	Quantity Per Case
051135-08691	6ml	12

3M™ Black Primer (Step 2)

- A black-colored, fast-drying product for use on windshield edges in combination with 3M™ Urethane Primer/Degreaser (PNs 08683 or 08685) prior to bonding with 3M™ Urethane Windshield Adhesives.
- Recommended for priming bare metal in the pinchweld to prevent corrosion.



Part Number	Size	Quantity Per Case
051135-08692	6ml	12

3M™ Urethane Primer Daubers

- Dauber for the application of urethane primers.

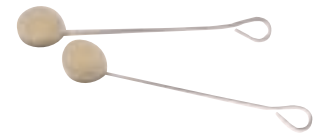

Part Number	Quantity Per Bag	Quantity Per Case
051135-08688	100	500

Auto Glass Urethane and Windshield Adhesives

3M™ Rapid Two-Part Urethane Adhesive (RTP)

- A two-part urethane adhesive designed for windshield bonding and stationary glass attachment.
- Exhibits a very fast rate of strength buildup.



Part Number	Container Size	Quantity Per Case
051131-08533	17 fl. oz.	6
051131-08534	11 fl. oz.	6

3M™ Auto Glass Urethane Windshield Adhesive

- A one-part moisture curing urethane adhesive designed for windshield bonding and stationary glass attachment.
- Meets FMVSS 212 and 216.
- Exceeds O.E.M. strength requirements.



Part Number	Container Size	Viscosity	Quantity Per Case
051135-08564	600ml Flex Pack	Medium	12

Auto Glass Urethane and Windshield Adhesives

3M™ Fast Cure Auto Glass Urethane

- A one-part moisture curing urethane adhesive designed for windshield bonding and stationary glass attachment.
- Meets FMVSS 212 and 216.
- Exceeds O.E.M. strength requirements.
- Fastest curing 3M one-part urethane.



Part Number	Container Size	Quantity Per Case
051135-08566	600ml Flex Pack	12

3M™ Windo-Weld™ Super Fast Urethane Black

- A rapid-curing adhesive/sealant intended for all flush mounted and bonded windshield or backlite replacements.
- Black odorless product.
- Easily applied.
- Cures quickly.
- Provides the necessary strength for automotive glass replacement.



Part Number	Container Size	Quantity Per Case
051135-08609	10 fl. oz. Cartridge	12

3M™ Auto Glass Urethane (High Modulus/Non-Conductive)

- A one-part high modulus/non-conductive auto glass urethane specifically designed to be used with later model European vehicles or any vehicle where the antenna is encapsulated in the glass.

Part Number	Container Size	Quantity Per Case
051135-08667	10.5 fl. oz. Cartridge	6

3M™ Fast Cure Auto Glass Urethane (High Viscosity)

- A one-part moisture curing urethane adhesive designed for windshield bonding and stationary glass attachment.
- Meets FMVSS 212 and 216.
- Exceeds O.E.M. strength requirements.
- Fastest curing 3M one-part urethane.
- GM-approved auto glass urethane.



Part Number	Size	Color	Quantity Per Case
051135-08689	450ml Flex Pack	Black	12
051135-08690	10.5 fl. oz. Cartridge	Black	12

3M™ Auto Glass Urethane Windshield Adhesive

- A one-part moisture curing urethane adhesive designed for windshield bonding and stationary glass attachment.
- Meets FMVSS 212 and 216.
- Exceeds O.E.M. strength requirements.



Part Number	Container Size	Viscosity	Quantity Per Case
051135-08693	10.5 fl. oz. Cartridge	Medium	12
051135-08695	450ml Flex Pack	Medium	12
051135-08696	10.5 fl. oz. Cartridge	High	12
051135-08698	450ml Flex Pack	High	12

Glass Damming Products

3M™ Windo-Weld™ Ribbon Sealer Black

- Its unique feature of “controlled” compressibility allows easy installation yet will not squeeze out or allow lute to contact pinch-weld.
- One kit or one 15' roll is sufficient material to replace one windshield or backlite.
- One 30' roll is sufficient material to replace two windshields or backlites.



Part Number	Size	Kits Per Case
INDIVIDUAL KITS — Round		
Contains one roll of sealer and setting blocks.		
051135-08610	Kit — 1/4" x 15'	12
051135-08611	Kit — 5/16" x 15'	12
051135-08612	Kit — 3/8" x 15'	12
BULK CASES — Round		
		Rolls Per Case
051135-08620	Roll — 1/4" x 15'	24
051135-08621	Roll — 5/16" x 15'	24
051135-08622	Roll — 3/8" x 15'	24
051135-08625	Roll — 1/8" x 1/4" x 30'	24

Glass Shop Belts

3M™ Duo-Glass™ Belts

- Specially designed for glass and mirror grinding, finishing and polishing.
- Features a Sinelok butt splice with uninterrupted mineral coating to reduce edge chipping and belt bumping at the splice.
- Polyester backing prevents the belt from stretching and losing its shape.
- Waterproof resin bond permits the belt to be used either wet or dry.



Part Number	Grade	Belts Per Box	Boxes Per Case
3" x 21"			
051144-04301	P220XF	5	10
051144-04303	P120XF	5	10
051144-04305	P80	5	10
3" x 24"			
051144-04308	P400XF	5	10
051144-04309	P220XF	5	10
051144-04310	P180XF	5	10
051144-04311	P120XF	5	10
051144-04313	P80	5	10
051144-04314	P60	5	10

3M™ Duo-Glass™ Belts (continued)

Part Number	Grade	Belts Per Box	Boxes Per Case
4" x 24"			
051144-04319	P120XF	5	5
4" x 64"			
051144-04329	P80	5	5
4" x 106"			
051144-04333	P220XF	5	
051144-04334	P180XF	5	5
051144-04335	P120	5	5
051144-04337	P80	5	5
051144-04338	P60	5	5
4" x 132"			
051144-04351	P120XF	5	5
051144-04353	P80	5	5

Glass Miscellaneous, Sealants, Adhesives and Cleaners

3M Shop/Glass Stand

- Sturdy, portable shop stand for convenient and efficient repairing of parts or for glass preparation.
- Portable for easy set up and storage.
- Constructed of 16 gauge 1" square tubing.
- Provides maximum floor surface for support and stability.
- Full 3/8" thick, durable rubber pads to protect parts and glass.
- Red epoxy powder paint for lasting durability and appeal.
- Maximum weight capacity: 250 lbs.
- Not stocked as a 3M item.
- To order, call Shopware at 1-800-877-9344.



Part Number	Quantity Per Case
051131-02519	1

3M™ Windo-Weld™ Resealant Black (Flow Grade)

- Flow grade sealant developed to stop leaks and as a supplementary seal on all "gasketless" windshield and backlite car models.
- Flows easily into pinholes and suspected water leaks.
- Dries fast into a flexible, rubbery seal.
- Adheres to glass and painted metal.
- Excellent resistance to weathering — no hardening or cracking.
- Pint can (PN08633) is for use with 3M™ Applicator Gun (PN08994).



Part Number	Container Size	Quantity Per Case
051135-08633	Pint Can	6
051135-08634	Fits 1/10 Gallon Cartridge Gun	12

3M™ Auto Bedding and Glazing Compound Black

- Non-hardening, pliable, water-resistant, medium bodied sealer for sealing auto seams and between windshield rubber and car body.
- Can be used as a supplementary sealer for auto glass installation.
- Remains permanently soft.
- Available in both neutral color and black.
- Has non-sag consistency for vertical and overhead applications.
- Cleans up with dry rag.



Part Number	Container Size	Cartridges Per Case
051135-08509	Fits 1/10 Gallon Cartridge Gun	12

3M™ Automix™ Channel Bonding and Sidelite Adhesive Black

- A flexible and durable adhesive used for bonding moveable and stationary automotive side glass into place.
- Has a 4–5 minute worklife and drive-away time of 1 hour.
- Dispensed with the 3M™ Automix™ Applicator Gun (PN08191) and 3M™ Automix™ Mixing Nozzles Clear (PN08197).



Part Number	Size	Quantity Per Case
051135-08641	2 oz.	6

3M™ Windo-Weld™ Sealer Black

- A one-part polysulfide adhesive sealant designed for use in the replacement of "bonded" windshields and backlites.
- Ideal for providing a supplementary seal for windshields installed with butyl tape.
- Requires no primer.
- Recommended substitute is 3M™ Super Fast Urethane (PN08609).



Part Number	Container Size	Cartridges Per Case
051135-08606	Fits 1/10 Gallon Cartridge Gun	12

3M™ Glass Cleaner

- Easy to use, quick acting, non-streaking aerosol glass cleaner.
- Excellent for cleaning glass, this product is also effective for use on plastic, chrome or metal.
- Safe, non-flammable formula.



Part Number	Net Wt.	Cans Per Case
051135-08888	19 oz. Aerosol	12

Applicator Guns and Accessories

MixPac® Applicator Gun

- For use with 3M™ Panel Bonding Adhesive (PN08115).
- Easy-to-use dispensing gun.
- Can dispense 2-1 or 1-1 MixPac® cartridges without plunger replacement.
- Easily dispenses urethanes and epoxies in 200 ml cartridges.
- Heavy-duty metal construction.
- To order PN09930, call Shopware at 1-800-877-9344.



Part Number	Description	Quantity Per Case
051135-08117	Manual Applicator Gun	1
051131-09930	Pneumatic Applicator Gun (Not stocked as a 3M item.)	1

MixPac® is a registered trademark of MixPac® Systems AG, Switzerland.

3M™ Automix™ Heavy Duty Applicator Gun

- Designed for use with all 3M™ Automix™ 2 oz. products.



Part Number	Quantity Per Case
051135-08191	1

3M™ Automix™ Mixing Nozzle 3/8"

- Designed for use with 3M™ Big Shot™ Applicator Gun (PN08198) and MixPac® Applicator Gun (PN08117).



Part Number	Quantity Per Bag	Bags Per Case
051131-08193	6	6

MixPac® is a registered trademark of MixPac® Systems AG, Switzerland.

3M™ Flex Pack Heavy Duty Applicator Gun

- A fully enclosed, all metal, rod driven, friction feed applicator gun.
- For use with 3M™ Windshield Urethanes.



Part Number	Container Size	Quantity Per Case
051135-08991	450ml	1

3M™ EPX Mixing Nozzle

- For use with all 3M™ Automix™ 2 oz. Cartridge products.



Part Number	Nozzles Per Bag	Bags Per Case
021200-21791	12	6

3M™ Flexible Package Applicator Gun

- A fully enclosed, all metal, rod driven, friction feed applicator gun for use with all 310ml or smaller foil flexible packages.



Part Number	Quantity Per Case
051135-08398	1

3M™ Air-Operated Flexible Package Applicator Gun

- Can be used with all 3M™ Flexible Package Seam Sealer offerings.
- Allows the end user to obtain a better reproduction of O.E.M. seams that are found in today's automobiles.
- Quick, easy and user friendly.
- To order, call Shopware at 1-800-877-9344.
- Not stocked as a 3M item.



Part Number	Quantity Per Case
051135-08399	1

Sprayable Seam Sealer Applicator Gun

- For use with 3M™ Ultrapro™ MSP Sprayable Seam Sealer (PNs 08364 and 08374).
- To order, call Shopware at 1-800-877-9344.
- Not stocked as a 3M item.



Part Number	Quantity Per Case
051135-08400	1

Applicator Guns and Accessories

3M™ No Cleanup Applicator Gun

- A one-piece metal applicator gun.
- Designed to be used with all 3M no cleanup application nozzles.
- Requires no cleaning.
- Refer to individual product instructions for proper air pressures.



Part Number	Quantity Per Case
051135-08801	1

3M™ Cartridge Applicator Gun

- 1/10 gallon Cartridge Gun for use with 3M™ Auto Bedding and Glazing Compound (PN08509) and 3M™ Windo-Weld™ Sealer (PN08606).



Part Number	Quantity Per Case
051135-08992	12

3M™ Professional Caulking Gun

- A high-performance gun, designed for the professional.
- Used for dispensing 11 oz. cartridges.



Part Number	Quantity Per Case
051135-08993	1

3M™ Applicator Gun

- For applying 3M automotive adhesives and sealers.
- Gun is furnished with two tips: windshield sealer application tip and an all-purpose needle tip.



Part Number	Quantity Per Case
051135-08994	12

3M™ Body Schutz™ Applicator Gun

- Developed to provide a unique, convenient and inexpensive means of spraying 3M™ Rubberized Body Schutz™ Coating (PN08864) and 3M™ Rocker Schutz™ (PN08874).



Part Number	Quantity Per Case
051135-08997	1

Mechanical and Electrical



Products

Brake Cleaner and Repair Products	181
Brake Rotor Discs	181
Cable Ties/Electrical . . .	193–194
Connectors/Electrical . . .	194–195
Displays and Accessories . . .	192
Fuel System Cleaners . . .	186–191
FSC Guides	186–187, 189
FSC Hardware and Adapters . . .	188–189, 191
FSC Tank Additives	190
Fuse Holder/Electrical	198
Heat Shrink Tubing	198–199
Intake System Cleaner	185
Machine Shop Products	180
Mechanical Cleaners and Lubricants	183–185
Mechanical Sealants and Adhesives	182–183
Professional Shop Rolls and Cloth Sheets	179–180
Retail Electrical Products . . .	200
Terminals/Electrical	196
Wire Marker Tapes (Dispensers) and Crimping Tools	196–197

Mechanical and Electrical



3M *Innovation*

Abrasive Rolls

3M™ Three-M-ite™ Elek-Tro-Cut™ Cloth Utility Rolls

- Used for smoothing rough spots, deburring and cleaning metal surfaces.



Part Number	Grade	Rolls Per Box	Boxes Per Case
1" x 50 Yards			
051144-05001	400	1	5
051144-05002	320	1	5
051144-05003	280	1	5
051144-05004	240	1	5
051144-05005	220	1	5
051144-05006	180	1	5
051144-05007	150	1	5
051144-05008	120	1	5
051144-05009	100	1	5
051144-05010	80	1	5
1-1/2" x 50 Yards			
051144-05021	400	1	5
051144-05022	320	1	5
051144-05024	240	1	5
051144-05026	180	1	5
051144-05027	150	1	5
051144-05028	120	1	5
051144-05029	100	1	5
051144-05030	80	1	5
2" x 50 Yards			
051144-05042	320	1	5
051144-05044	240	1	5
051144-05046	180	1	5
051144-05047	150	1	5
051144-05048	120	1	5
051144-05049	100	1	5
051144-05050	80	1	5

3M™ Wetordry™ Fabricut™ Rolls

- Made from a flexible, synthetic open mesh screen-type backing.
- Coated on both sides with tough aluminum oxide mineral.
- Ideal for cleaning rusted or corroded surfaces.
- Can be used with or around water, oil, or axle grease without loading.

Part Number	Grade	Rolls Per Case
1-1/2" x 25 Yards		
051144-05071	180	5
051144-05072	120	5
051144-05073	80	5

3M™ Professional Shop Rolls

- Designed for general-purpose production sanding and deburring operations, by hand or by machine.
- Can be used for a wide variety of metal preparation — soldering, welding, rust removal and other contaminants.

Part Number	Grade	Rolls Per Case
1" x 20 Yards		
051131-05100	P400J	5
051131-05101	P320J	5
051131-05102	P240J	5
051131-05103	P180J	5
051131-05104	P150J	5
051131-05105	P120J	5
051131-05106	P80J	5
1-1/2" x 20 Yards		
051131-05107	P400J	5
051131-05108	P320J	5
051131-05109	P240J	5
051131-05110	P180J	5
051131-05111	P150J	5
051131-05112	P120J	5
051131-05113	P80J	5

Machine Shop Products

3M™ Tri-M-ite™ Silicon Carbide Belt

- Coated abrasive belts.
- Designed to be used with most head resurfacing machines which utilize belts.

Part Number	Size	Grade	Belts Per Case
051131- 04423	14" x 107"	40	5

3M™ Crankshaft Polishing Belts

- 3M™ Three-M-ite™ Elek-Tro-Cut™ Cloth Belts.
- Many uses in both production and maintenance jobs.
- Flexible cloth backing.
- Coated with aluminum oxide mineral.

Part Number	Size	Grade	Belts Per Nest	Belts Per Case
051144- 04501	1" x 64"	P400	25	4
051144- 04516	1" x 65"	P400	25	4
051144- 04541	1" x 77"	P400	25	4
051144- 04561	1" x 91"	P400	25	4

Scotch-Brite™ Bench Motor Wheel

- Excellent when used on a bench motor to clean, deburr, blend, finish or polish all types of metals, composites or plastics.



Part Number	Each Per Case
051131- 07744	5

Cloth Sheets

3M™ Three-M-ite™ Elek-Tro-Cut™ Cloth Sheets

- Metal sanding.
- Deburring.
- Quick cleanup by hand.

Part Number	Grade	Sheets Per Sleeve	Sleeves Per Case
9" x 11"			
051144- 02402	P400	50	5
051144- 02404	P280	50	5
051144- 02406	P180	50	5
051144- 02407	P150	50	5
051144- 02408	P120	50	5
051144- 02409	P100	50	5
051144- 02410	P80	50	5

3M™ Crystal Bay™ Cloth Sheets

- Emery Cloth — for general purpose metal sanding, light cleanup work and rust removal.
- Crocus Cloth — for polishing metal.



Part Number	Grade	Sheets Per Sleeve	Sleeves Per Case
9" x 11"			
051144- 02431	Emery-Fine	50	5
051144- 02432	Emery-Medium	50	5
051144- 02433	Emery-Coarse	50	5

3M™ Roloc™ Brake Rotor Discs

3M™ Roloc™ Brake Rotor Surfacing Discs

- A premium 120 grit 3M™ Roloc™ disc designed to create a non-directional scratch pattern on brake rotor surfaces after turning.
- Starter pack includes nine 3" 3M™ Roloc™ Brake Rotor Surfacing Discs and 1 3M™ Roloc™ Disc Pad.
- Refill pack includes 12 3M™ Roloc™ Brake Rotor Surfacing Discs.



Part Number	Description	Packs Per Case
051131-01410	Starter Pack	12
051131-01411	Refill Pack	12

Brake Cleaner and Repair Products

3M™ High Power Brake Cleaner

- Powerful flushing action that dries without leaving residues.
- A non-chlorinated, general-purpose degreaser.
- Designed to quickly remove oil, grease, brake fluid and other contaminants from all types of brake assemblies and parts without disassembling the unit.
- Contains no ozone depleting ingredients.
- Widespray button designed for comfort.



Part Number	Net Wt.	Cans Per Case
051135-08180*	14 oz. Aerosol	12

* Fast drying formulation that complies with current (as of January 2005) CARB and OTC regulations for automotive brake cleaners; consult local regulations.

Part Number	Net Wt.	Cans Per Case
051135-08880**	14 oz. Aerosol	12

** Exceeds 45% VOC; consult local regulations.

3M™ Brake Cleaner

- Excellent wetting out performance to flush away grease, brake dust and brake fluid.
- Does not contain harmful chlorinated solvents.
- May be used for cleanup work on clutch assemblies and fly wheels.
- Convenient, fast cleanup system.
- Suitable for use where non-chlorinated solvent type cleaners are required.
- Exceeds 45% VOC; consult local regulations.



Part Number	Net Wt.	Cans Per Case
051135-08895	14 oz. Aerosol	12

3M™ Brake Lube/ Anti-Seize Copper

- Lubrication and corrosion protection of tight fitting or dissimilar metal parts to help prevent seizure.
- Withstands temperatures up to 1800°F range.
- Easy application.
- Controlled application.
- Convenient, cost-effective can size.



Part Number	Net Wt.	Cans Per Case
051135-08945	9 oz.	6

Mechanical Sealants and Adhesives

3M™ Super Weatherstrip Adhesive



- Bonds all types of gaskets to painted or unpainted metal surfaces.
- Adhesive stays permanently flexible and rubbery, never dries out or becomes hard.
- Easy to brush and spread.
- Extremely fast-drying.
- Exceptional bonding strength.
- Waterproof.
- Flexible (rubbery).
- Resists oil, grease and solvents.

Part Number	Color	Container Size	Tubes Per Case
051135-08001	Yellow	5 oz. Tube	6
051135-08002	Yellow	2 oz. Tube	12
051135-08008	Black	5 oz. Tube	6

3M™ Weatherstrip Adhesive Black



- Fast-drying adhesive used for bonding and sealing weather stripping.
- Also an excellent adhesive for new EPDM weather stripping.
- Easy to apply.
- Remains flexible.
- Waterproof.

Part Number	Container Size	Tubes Per Case
051135-08011	5 oz. Tube	6

3M™ Plastic and Emblem Adhesive Clear



- Excellent adhesive for plastic repair and emblem application.
- May be used for interior or exterior bonding.
- Used for bonding metal emblems, rigid plastic parts, taillight lenses and vinyl trim strips.
- Strong.
- Quick-drying.
- One surface application.

Part Number	Container Size	Tubes Per Case
051135-08061	5 oz. Tube	6

3M™ General Trim Adhesive Clear

- A low VOC, high-strength adhesive for bonding automotive materials (carpeting, jute pads, fabrics, plastics) to metal and other surfaces.
- Good heat and water resistance.
- Not recommended for bonding polystyrene foam. (For bonding polystyrene foam, use 3M™ Spray Trim Adhesive PN08074).



Part Number	Container Size	Cans Per Case
051135-08088	16.25 fl. oz. Aerosol	6

3M™ Ultrapro™ High Temp Silicone Gasket



- Premium grade compound for form-in-place gasketing.
- Range from -20°F to 600°F intermittent.
- Oxygen sensor safe.

Part Number	Color	Container Size	Tubes Per Case
051135-08672	Black	3 fl. oz. Tube	6

3M™ Structural Adhesive Kit



- Two-part general purpose structural adhesive that may be used for bonding metal, glass and plastic.
- May be used for trim, fiberglass and flexible body parts repair.
- Easy mixing.
- Sets up quickly.
- Spreads smoothly.
- Cures to an extremely strong bond.

Part Number	Color	Container Size	Containers Per Kit	Kits Per Case
051135-08101	Gray	2 fl. oz. Tube	2	6

3M™ Quick Fix Adhesive Clear (Cyanoacrylate)



- Strong, rapid bonding, convenient to use adhesive.
- Good adhesion to rubber weather stripping, vinyl, metal, glass, side moldings, emblems, trim pieces and most plastics.
- Excellent resistance to temperature extremes, shock (such as slamming a door) and most automotive fluids.

Part Number	Size	Bottles Per Case
051135-08155	1 oz. Bottle	12

3M™ Clear Auto Sealer



- Used for sealing leaks in windshields, backlites, reveal moldings, truck ornaments, taillights and other small seams on the auto body.
- Flexible and color stable.
- May be water tested soon after application.
- Will not harden or become brittle.
- Dries to smooth, bubble-free film.

Part Number	Container Size	Tubes Per Case
051135-08551	5 oz. Tube	6

Mechanical Sealants and Adhesives

3M™ Super Silicone Sealant

- Rapid-curing adhesive/sealant formulated to solve repair and maintenance problems.
- Excellent gasket adhesive and form-in-place gasket material.
- Adheres to a wide variety of automotive surfaces.



Part Number	Color	Container Size	Quantity Per Case
Boxed			
051135-08661	Clear	3 oz. Tube	12
051135-08662	Black	3 oz. Tube	12
Cartridges			
051135-08663	Clear	Fits 1/10 Gallon Cartridge Gun	12
051135-08664	Black	Fits 1/10 Gallon Cartridge Gun	12

3M™ Ultrapro™ Silicone Gasket

- Designed to be used as a gasket material for valve covers, oil pans and other engine and transmission applications.
- Flexible at -20° to 600°F.
- Oxygen sensor safe.
- Low odor/non-corrosive.
- Oil resistant.



Part Number	Color	Size	Quantity Per Case
051135-08700	Black	3 oz.	12
051135-08704	Gray	3 oz.	12

3M™ High-Strength Threadlocker Red

- Keeps threaded fasteners from loosening.
- Heavy-duty professional formula.
- Extreme temperature resistance up to 300°F.
- Heat required for disassembly.
- Ideal for 3/8" and larger fasteners.



Part Number	Size	Quantity Per Case
051135-08730	0.34 oz.	12

3M™ Medium-Strength Threadlocker Blue

- Keeps threaded fasteners from loosening.
- General purpose applications.
- Extreme temperature resistance up to 300°F.
- Ideal for 1/4" to 1" fasteners.



Part Number	Size	Quantity Per Case
051135-08731	0.34 oz.	12

3M™ Rearview Mirror Adhesive

- Permanently bonds mirror bracket to windshield.
- Professional strength.



Part Number	Size	Quantity Per Case
051135-08752	.02 oz. (adhesive) .02 oz. (primer)	12

Mechanical Cleaners and Lubricants

3M™ Choke & Carb Cleaner

- New formula allows product to be used on hot or cold engine.
- Powerful penetrating ingredients loosen gum, oil and varnish.
- High delivery rate flushes away loosened deposits.
- For automotive and marine use.
- Use on automatic chokes, carburetor assemblies and linkages.
- Oxygen sensor safe.
- Through-the-engine formula.



Part Number	Net Wt.	Cans Per Case
051135-08796	12.5 oz. Aerosol	12

3M™ Throttle Plate & Carb Cleaner

- Fast cleaning action for dirty throttle plates.
- Can be sprayed upside down.
- Cleans and lubricates.
- Safe for coated throttle plates.



Part Number	Net Wt.	Cans Per Case
051131-08866	8.5 oz. Aerosol	12

Mechanical Cleaners and Lubricants

3M™ White Grease (Lithium Lube)

- Long-lasting lubrication.
- Easy spray viscosity.
- Won't drip or run.
- Resists "washing out" if exposed to road spray.



Part Number	Net Wt.	Cans Per Case
051135-08875	10.5 oz. Aerosol	12

3M™ Glass Cleaner

- Easy to use, quick-acting, non-streaking aerosol glass cleaner.
- Excellent for cleaning glass, this product is also effective for use on plastic, chrome or metal.
- Nonflammable.



Part Number	Net Wt.	Cans Per Case
051135-08888	19 oz. Aerosol	12

3M™ Silicone Lubricant Plus (Wet Type)

- High solids version of PN08897.
- Provides increased lubricating qualities, especially on sliding parts.
- High solids content.
- Long-lasting.
- Facilitates the installation of rubber-set windshields.
- Will not freeze at -28°F.
- Will not degrade at 350°F.
- Seals out moisture.



Part Number	Net Wt.	Cans Per Case
051135-08877	9 oz. Aerosol	12

3M™ Silicone Lubricant (Dry Type)

- High quality silicone lubricant.
- Eliminates rubber squeaks and prevents sticking.
- Contains no petroleum oils to stain fabrics.
- Will not freeze at -28°F.
- Will not degrade at 350°F.
- Seals out moisture.



Part Number	Net Wt.	Cans Per Case
051135-08897	8 oz. Aerosol	12

3M™ Spray Lube

- A clear, flowable, high-performance, general purpose grease.
- Designed to be water resistant.
- Can be used to lubricate many items including hinges, latches and seat tracks.
- Flows as a liquid then sets up to a uniform coating of grease.



Part Number	Net Wt.	Cans Per Case
051135-08878	11 oz. Aerosol	12

3M™ 4-Way Spray Lubricant & Penetrant

- Specialized formula for general or all-around use.
- Provides characteristics of a lubricating oil, a penetrating oil, a demulsifying coating, a thin bodied, transparent rust inhibitor.
- Literally, a "4-in-1" general purpose spray material which contains no silicone.
- Lubricates, stops squeaks.
- Frees rusted bolts.
- Drives out moisture.
- Excellent penetrant.

Part Number	Net Wt.	Cans Per Case
051135-08898	10.5 oz. Aerosol	12

Mechanical Cleaners and Lubricants

3M™ Foaming Engine Degreaser

- General purpose engine degreaser.
- For removal of grease, grime and dirt.
- Safe for under-the-hood rubber and plastic parts.



Part Number	Net Wt.	Cans Per Case
051135-08899	16.5 oz. Aerosol	12

3M™ Gasket Prep and Parts Cleaner

- Fast-drying, leaves no residue.
- Cleans surfaces, promoting adhesion of gasket dressings and RTVs.
- Dissolves and flushes away oil, grease and other contaminants.
- Non-chlorinated formula.



Part Number	Net Wt.	Cans Per Case
051131-08901	14 oz. Aerosol	12

3M™ Silicone Paste Clear

- Dielectric grease.
- Lubricates and conditions rubber products without potentially harmful solvents.
- No solvents to wash off.
- Good control of where product is being applied resulting in less cleanup.
- Universal application where appearance is important.
- Convenient, cost-effective can size.



Part Number	Net Wt.	Cans Per Case
051135-08946	8 oz.	6

3M™ Intake System Cleaner Point of Purchase Display

- Contains the following:
 - 1 3M™ Intake System Cleaner shop poster.
 - 1 3M™ Intake System Cleaner counter stand.
 - 50 3M™ Intake System Cleaner brochures.
 - 1 3M™ Intake System Cleaner counter mat.

Part Number	Quantity Per Case
051131-02507	1

3M™ Intake System Cleaner (Aerosol)

- A proprietary blend of cleaners that provides a total system cleanup when used in conjunction with 3M™ Throttle Plate and Intake Cleaner (PN08866) and 3M™ Fuel System Cleaner Tank Additive (PN08813).
- Requires the use of 3M™ Intake System Cleaner Adapter Kit (PN08960) to apply cleaner to the engine.



Part Number	Net Wt.	Quantity Per Case
051135-08958	9 oz. Aerosol	12

3M™ Intake System Cleaner Adapter Kit (Aerosol)

- Used in conjunction with 3M™ Intake System Cleaner (Aerosol) (PN08958).



Part Number	Quantity Per Case
051135-08960	1

3M™ Intake System Cleaner 3-Pack (Aerosol)

- Contains one each of 3M™ Intake System Cleaner (Aerosol) (PN08958), 3M™ Throttle Plate and Intake Cleaner (PN08866) and 3M™ Fuel System Cleaner Tank Additive (PN08813).



Part Number	Quantity Per Case
051135-08962	6

3M™ Prep Solvent-70

- A water-based solvent used to remove oil, wax, grease and silicone from surfaces prior to coating.
- Effectively cleans metal, primed metal and painted surfaces prior to the application of primer or paint.
- Rated at 70 grams per liter of volatile organic compounds (VOC).
- Currently meets regulations governing VOC emissions of surface preparation solvents.



Part Number	Container Size	Containers Per Case
051135-08983	Gallon	4

Fuel System Cleaner Guide

- Removes Carbon Deposits from Intake Valves and Combustion Chambers

Intake Valves



- Cleans Fuel Injectors

Fuel Injectors

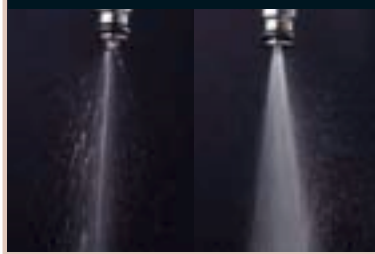

- Cleans Throttle Plate and Intake Manifold
- Restores Power, Performance and Fuel Economy
- Decrease Exhaust Emissions

Throttle Body



General Directions for Use:

1. Refer to the **SAFETY INFORMATION, FUNDAMENTAL PREPARATION and TROUBLESHOOTING** sections contained in the 3M™ Fuel System Cleaning Quick Check Guide, PN08817 (Hardbound Manual) or PN08816 (CD-ROM) for additional support information. Failure to read and follow all applicable instructions could result in misuse, serious personal injury and/or property damage.
2. Refer to **SECTION 6: 3M™ Fuel System Cleaner QUICK CHECK GUIDE PN08817** for alphabetical index of vehicles and select proper 3M™ Fuel Supply Line Adapter(s) for the vehicle application (make, model, engine, type of fuel system, fuel pressure and fuel pump disable location).
3. 3M Product Selection Recommendations: Vehicles having basic injector deposit problems can be treated with either 3M™ Universal Fuel Injector Cleaner or 3M™ Universal Fuel System Cleaner. Vehicles that are suspected of having deposits extending beyond the injectors (intake valves & combustion chambers) should be treated with 3M™ Universal Fuel System Cleaner.

3M™ Universal Fuel Injector Cleaner (PN08956) is a proprietary blend of solvents, designed to run the engine during the cleaning procedure while cleaning the injectors as the cleaner passes through them.

3M™ Universal Fuel System Cleaner (PN08955) is a proprietary, complex mixture of high octane fuel, deposit removing solvents, a water micro-emulsion, detergent-dispersants, corrosion inhibitors and lubricants. It is designed to run the engine during the cleaning procedure, cleaning the injectors and carbon deposits on the intake valves and combustion chambers. It is excellent for Periodic Maintenance.

Cleaning Procedure Steps:

1. Bring the engine to normal operating temperature.
2. Disable the vehicle's fuel pump. Refer to proper location and method in the 3M™ Fuel System Cleaning Quick Check Guide. The engine should stall in a few moments as the fuel pressure drops.
3. Turn the ignition and all accessories OFF (AC, Fans, Defrosters).
4. Vent fuel tank(s) of pressure or vacuum by opening and closing the filler cap.
5. If applicable, disconnect and plug the vacuum hose on the engine's fuel pressure regulator.
6. Check the seal in the end of the cleaner hose, replace if cut or missing.
7. Screw the fuel system supply adapter into the female end of the cleaner hose, **HAND TIGHTEN ONLY**.
8. Close the valve on the cleaner hose to the OFF position.
9. Attach the fuel system supply adapter and cleaner hose to the engine's fuel delivery system. **CAUTION:** The fuel system may still hold pressurized fuel! Use a shop towel around fittings to slowly relieve and capture any remaining pressurized fuel.
10. Remove the quick-connect can adapter (PN08927) from the cleaner hose or regulator by depressing the silver tab and pulling gently apart.
11. Turn the knob on the regulator fully counter clockwise to the OFF position.

Fuel System Cleaner Guide

3M™ Fuel System Cleaner



12. Attach the regulator to the cleaner hose at the quick-connect. **IMPORTANT!** Make sure the quick-connects move freely and lock securely prior to each use.
13. Thread the quick-connect can adapter to the can of 3M cleaner. **HAND TIGHTEN ONLY.**
14. With the can in the upside down position, attach it to the regulator. **NOTE:** The can of cleaner must be kept upside down throughout the cleaning procedure!
15. Clip the can hanger (PN08937) to the can of 3M cleaner and hang it securely in a safe location under the hood.
16. Slowly turn the knob on the regulator clockwise to adjust the cleaning pressure 3–6 PSI below the fuel system's normal operating pressure.
17. Open the valve on the cleaner hose and inspect for leaks. If a leak is detected, stop immediately and correct before proceeding!
18. Start the engine and let it idle. **NOTE:** The pressure may need to be readjusted during the cleaning to maintain desired pressure or engine idle quality.
19. When the can is empty the engine will stall. Turn the vehicle's ignition OFF. Turn the cleaner hose valve OFF. Turn the knob on regulator fully counterclockwise to the OFF position. **CAUTION:** The engine's fuel system, 3M regulator and cleaner hose will have residual pressure and cleaner. Wrap a shop towel around the fittings while disconnecting!
20. Press the silver quick-connect tab to disconnect the can adapter and empty can of cleaner from the regulator.
21. Depressurize pressure regulator, hose and fuel system before disconnecting. Wrap a shop towel around the quick-connect fitting on the top of the regulator. Turn the knob on the regulator clockwise – ON. Slowly open the valve on the cleaner hose to bleed off pressure.
22. Turn the knob on the regulator fully counter clockwise – OFF, separate the pressure regulator from cleaner hose and return to the protective foam holder.
23. Remove the cleaner hose and fuel system adapter from the engine.
24. Remove the can adapter and can hanger from the empty can of cleaner; clean and retain for future use.
25. Reassemble all of the original connections for fuel lines, vacuum hose and fuel pump disable on the vehicle. Cycle the ignition several times to pressurize the fuel system and check for leaks. Start the engine check for leaks and test-drive the vehicle.

Equipment Maintenance:

To maintain optimum performance with 3M™ Fuel System Cleaning hardware, clean or flush after each use with 3M™ Throttle Plate Cleaner. Thoroughly inspect each part before and after each use. Keep all hardware parts safely and neatly stored inside the kit box. Replace all damaged or worn parts.

For additional information contact:

3M Automotive Aftermarket Division
1-877-MMM-CARS (1-877-666-2277)
Or visit us at our web site: www.3M.com/automotive

Fuel System Cleaner Hardware and Adapters

3M™ Fuel System Cleaner Basic Adapter Kit

- A basic assortment of adapters designed to enable a shop to perform fuel system cleanings with 3M™ Universal Fuel System Cleaner (PN08955) and 3M™ Universal Fuel Injector Cleaner (PN08956) on a select number of fuel-injected vehicles on the road today.
- Contains 3M™ Fuel System Cleaning Application Guide (User's Manual)
- Features a large, hinged storage case made of a durable plastic
- **NOTE:** Individual Adapters are **NOT AVAILABLE** from 3M. They may be ordered directly from 3M Adapter Center at American Jetway by calling 1-800-773-1594 or fax at 1-800-805-7479. Kits are **NOT AVAILABLE** at this number.

Part Number	Kits Per Case
051135- 08829	1

(See chart on page 191)

Part Number	Description	Quantity Per Kit
Kit Contains:		
08817	Fuel System Cleaning Quick Check Guide	1
08822	Right-angle, 5/16" x 32 Thread, Schrader Adapter	1
08837	Can Hanger (for PNs 08955 and 08956)	1
08838	Cleaner Hose with Tab-Lock Quick-Connect	1
08917	Right-angle, 7/16" x 20 Thread, Schrader Adapter	1
08919*	Banjo Eye Bolt, 12mm	1
08920*	5/16" Hose Adapter	1
08828	Pressure Gauge/Regulator	1

* With the use of the end cap, PN08825, these adapters will also function as plugs.

3M™ Universal Fuel Injector Cleaner Kit

- Kit contains the following:
 - 3M™ Fuel Injector Cleaner Can Hanger (PN08837).
 - 3M™ Fuel Injector Cleaner Long Hose (PN08838).
 - 3M™ Gauge/Regulator for Fuel Injector Cleaner Systems (PN08828).



Part Number	Kits Per Case
051135- 08836	1

3M™ Fuel System Cleaner Deluxe Adapter Kit**

- An assortment of adapters designed to enable a shop to deliver 3M™ Universal Fuel System Cleaner (PN08955) and 3M™ Universal Fuel Injector Cleaner (PN08956) to 85%–90% of the fuel-injected vehicles on the road today.
- Contains a 3M™ Fuel System Cleaning Application Guide (User's Manual).
- The rugged, plastic box consists of a large, hinged top container and two detachable slide-out trays.
- **NOTE:** Individual Adapters must be ordered directly from 3M Adapter Center at American Jetway by calling 1-800-773-1594 or fax at 1-800-805-7479. 3M™ Fuel System Cleaner Kits (PNs 08829 and 08830) are **NOT AVAILABLE** at this number.

Part Number	Kits Per Case
051135- 08830	1

(See chart on page 191)

Part Number	Description	Quantity Per Kit
Kit Contains:		
08552	11mm O.D. Single O-ring Adapter	1
08817	Fuel System Cleaning Quick Check Guide	1
08820	Fuel Line Disconnect Tool Set	1
08821	Straight, 7/16" x 20 Thread, Schrader Adapter	1
08822	Right-angle, 5/16" x 32 Thread, Schrader Adapter	1
08823	Straight, 5/16" x 32 Thread, Schrader Adapter	1
08824*	5/16" Male Quick-Connect Adapter	1
08825	End Cap, 7/16" x 20 Thread	1
08828	Gauge/Regulator	1
08831*	19 mm OD Fuel Line Adapter	1
08833*	3/8" ID Female Quick-Connect Adapter	1
08834*	3/8" OD Male Quick-Connect Adapter	1
08837	Can Hanger (for PNs 08955 and 08956)	1
08838	Cleaner Hose with Tab-Lock Quick-Connect	1
08843	Two Hose Clamps, 5/16" and 1/2"	1
08844	Banjo Bolt, 12 mm x 1.25 Thread	1
08845	Plug, 14 mm x 1.5 Thread with O-ring Seal	1

* With the use of the end cap, PN08825, these adapters will also function as plugs.

** This represents the current mix of adapters for this kit. The Deluxe Adapter Kit is continually reviewed and regularly changed in order to provide the best assortment of adapters to meet the needs of the professional technician. Our goal continues to be the availability of the 3M™ Fuel System Cleaner Deluxe Adapter Kit that accommodates 90+% of the vehicles on the road.

Fuel System Cleaner Hardware and Adapters

3M™ Fuel System Cleaner Deluxe Adapter Kit** (continued)

Part Number	Description	Quantity Per Kit
Kit Contains:		
08854*	5/16" Female Quick-Connect Adapter	1
08857	12mm x 1.5 Thread, Swivel Nut Adapter	1
08858	Banjo Bolt, 12mm x 1.5 Thread	1
08860*	15mm OD Fuel Line Adapter	1
08863*	7/16" OD Male Quick-Connect	1
08917	Right-angle, 7/16" x 20 Thread, Schrader Adapter	1
08919*	Banjo Eye Bolt, 12mm	1
08920*	5/16" Hose Adapter	1
08921*	14mm x 1.5 Thread, Swivel Nut Adapter	1
08922*	Straight, 5/8" x 18 Thread, TBI Adapter	1
08923*	9/16" OD Male Quick-Connect	1
08927	Tab-Lock Quick-Connect, for PN08838 Hose	1
08871	Banjo Belt, 12mm x 1.25 Thread, Schrader Valve	1
08872	14mm x 1.5 Thread, Inverted Fuel Line Flare	1

3M™ Fuel System Cleaner Deluxe Adapter Kit** (continued)

Part Number	Description	Quantity Per Kit
Kit Contains:		
08932*	Flow Restrictor with 7/16" x 20 Female	1
08937	Washer and O-ring Assortment	1
08941*	Banjo Bolt, 8mm x 1.0 Thread	1
08944	Banjo Bolt with Cap Nut, 12mm x 1.5 Thread	1

* With the use of the end cap, PN08825, these adapters will also function as plugs.

** This represents the current mix of adapters for this kit. The Deluxe Adapter Kit is continually reviewed and regularly changed in order to provide the best assortment of adapters to meet the needs of the professional technician. Our goal continues to be the availability of the 3M™ Fuel System Cleaner Deluxe Adapter Kit that accommodates 90+% of the vehicles on the road.

Fuel System Guide

3M™ Fuel System Cleaning Application Guide CD

- CD-ROM based guide for the application of 3M™ Universal Fuel System Cleaner (PNs 08955 and 08911) and 3M™ Universal Fuel Injector Cleaner (PN08956).
- Features step-by-step instructions for most domestic vehicles, including where to hook-up, required system operating pressures, fuel pump disconnect location, required 3M adapter(s), etc.
- Allows for quick searching by make, model and engine to bring up appropriate instructions and diagrams.
- Windows® 95/98/NT based application for IBM® compatible PC's having a minimum of 100MB of hard drive disk space available to install the program and files.



Part Number	Quantity Per Case
051131-08816	1

Windows® is a registered trademark of Microsoft Corporation. IBM® is a registered trademark of IBM Corporation.

3M™ Fuel System Cleaning Quick Check Guide

- Bound, paper manual.
- Ideal for quick reference by professional technicians.
- Includes required cleaning pressures, hook-up locations, adapters required, fuel pump disconnect locations, etc.
- Covers most domestic makes and models.



Part Number	Quantity Per Case
051131-08817	1

Fuel System Cleaners

3M™ Universal Fuel System Kit (120 psi)

Kit contains the following:

- 1 can of 3M™ Universal Fuel System Cleaner (PN08955).
- 1 bottle of 3M™ Fuel System Cleaner Tank Additive (PN08813).
- 1 can of 3M™ Throttle Plate and Intake Cleaner (PN08866).



Part Number	Quantity Per Case
051135-08911	6

3M™ Universal Fuel Injector Cleaner

- Restores injector efficiency.
- Decreases exhaust emissions.
- Improves fuel atomization.
- Must be used with 3M™ Gauge/Regulator (PN08828).



Part Number	Net Wt.	Cans Per Case
051135-08956	10 oz. Aerosol	12

3M™ Universal Fuel System Cleaner

- Formulated to clean intake valves, combustion chamber and fuel injector deposits.
- Works on high-pressure fuel systems.
- Recommended for professional use only.
- Must be used with 3M™ Gauge/Regulator (PN08828).



Part Number	Net Wt.	Cans Per Case
051135-08955	12 oz. Aerosol	12

Fuel System Cleaner Tank Additives

3M™ Fuel Injector Cleaner Tank Additive

- Cleans fuel injection deposits.
- Restores power and fuel economy.
- One bottle per tank of gas helps to eliminate stalling, hesitation and poor performance due to dirty fuel injector deposits.



Part Number	Quantity Per Case
051135-08812	6

3M™ Fuel System Cleaner Tank Additive

- A concentrated detergent formula designed to be added to the fuel tank to facilitate the cleaning of intake valves, combustion chambers and fuel injectors.
- Restores power, performance and fuel economy.
- Protects against carbon buildup and engine knock.



Part Number	Quantity Per Case
08813*	6

* UPC Number is 051131-16313

Fuel System Cleaner/Fuel Injector Cleaner Adapters

3M™ Fuel System Cleaner Adapters

Part No. and Description	Parts and Tools
PN08552 11 mm O.D. Single O-ring Adapter	
PN08820 Fuel Line Disconnect Tool Set: 5/16, 3/8, 1/2, 5/8, 3/4 & 7/8	
PN08821 7/16-20 Thread Schrader Adapter	
PN08822 5/16-32 Thread Schrader Adapter	
PN08823 5/16-32 Thread Schrader Adapter	
PN08824 5/16 OD Male Quick Connect Adapter	
PN08825 7/16-20 Thread End Cap. Caps All Adapters with 7/16-20 Male Threads	
PN08826 5/8-18 Thread TBI Swivel Nut with Single O-ring Adapter	
PN08827 10 -1.0 mm Thread Banjo Bolt Adapter	
PN08828 3M Gauge Regulator, tri-scale: bar/kPa/PSI	
PN08831 19 mm OD Single O-ring Adapter	
PN08833 3/8 ID Female Quick Connect Adapter	
PN08834 3/8 OD Male Quick Connect Adapter	
PN08836 Fuel System Cleaner Starter Kit. Contains One Each: Gauge Regulator PN 08828, Can Hanger PN 08837, Cleaner Hose PN 08838	
PN08837 Aerosol Can Hanger	
PN08838 3M Cleaner Hose: Includes Quick Connect Can Adapter PN08927. Has a 7/16-20 Female Hose End for Various Adapters (not included).	
PN08843 Two Hose Clamps 5/16 and 1/2 Inch	
PN08844 12 - 1.25 mm Thread Banjo Bolt Adapter	
PN08845 14-1.5 mm TBI Plug with O-ring	
PN08846 1/2-20 Thread Plug with Inverted Flare	
PN08849 17/32-18 Thread Plug with Inverted Flare	
PN08853 1/4 Female Quick Connect with Plugged End	
PN08854 5/16 ID Female Quick Connect Adapter	
PN08855 Fuel Line Loop with 7/16 & 9/16 ID Female Quick Connect	
PN08856 Fuel Line Loop with 1/4 & 5/16 OD Male Quick Connect	

Part No. and Description	Parts and Tools
PN08857 12-1.5 mm Thread Swivel Nut Adapter	
PN08858 12-1.5 mm Thread Banjo Bolt	
PN08859 11mm OD Single O-ring Fuel Line Adapter with 7/16-20 Male Hose End	
PN08860 15 mm OD Single O-ring Adapter	
PN08861 5/16 ID Hose with Plugged End	
PN08862 Fuel Line Loop 1/4 & 5/16 OD Slip-Fit Hose Ends	
PN08863 7/16 OD Dbi O-ring Male Quick Connect Adapter	
PN08871 12-1.25 mm Thread Banjo Bolt with Schrader Valve Adapter	
PN08872 14 -1.5 mm Thread Bolt with Inverted Flare Adapter	
PN08917 7/16-20 Schrader Adapter	
PN08919 12 mm ID Banjo Eye Bolt Adapter	
PN08920 5/16 ID Hose Adapter	
PN08921 14-1.5 mm Thread Swivel Nut Adapter	
PN08922 5/8-18 Thread TBI Swivel Nut with Single O-ring Adapter	
PN08923 9/16 OD Dbi O-ring Male Quick Connect Adapter	
PN08927 Aerosol Can Adapter with Locking Quick Connect For use with 3M Cleaner Hose PN08838 and 3M Gauge Regulator PN 08828.	
PN08931 5/16-32 Thread Schrader Adapter with Quick Connect Adapter	
PN08937 Seal & O-ring Assortment (not inclusive)	
PN08941 8 - 1.00 mm Thread Banjo Bolt Adapter	
PN08944 12 - 1.5 mm Thread Dbi Banjo Bolt, with Cap Nut and Copper Seals	
0001-AJ Empty Yellow Kit Box (see PN08829 or PN08830)	
0002-AJ Empty Kit Drawer - Stackable (see PN08830)	
PN08960-ADP Tapered Brass Adapter (Optionally used with PN08960 Kit)	
PN08960-A Replacement Coiled Cleaner Hose for PN08960 Kit	
PN08960-Y Splitter Assembly (Optionally use with PN08960 to apply cleaner to engines with two throttle bores)	

To order call 3M Adapter Center at American Jetway at 1-800-773-1594 or fax at 1-800-805-7479.

- Designed to fit vehicles equipped with multi-port fuel injection.
- Adapter mounts in universal fitting on the 3M™ FIC Hose (PN08838) Hose Assembly for use with 3M™ Universal Fuel Injection Cleaner (PN08956) and 3M™ Universal Fuel System Cleaner (PN08955).
- Designed for use with the 3M™ Fuel Injector Cleaner Hose (PN08838) and the appropriate vehicle adapter.
- Allows the use of 3M™ Universal Fuel Injector Cleaner (PN08956) without the need to clamp return lines.
- Designed for use with 3M™ Fuel System Cleaner for high pressure systems.
- Solid brass construction.
- Adapters may be purchased one at a time.

Merchandising Displays and Accessories

3M™/NASCAR Racing Decals

- Same decal that appears on many racing cars in the NASCAR Nextel Cup Series.
- Can be used on most surfaces.
- Can be reapplied and reused.
- Dimensions: 4-1/4" H x 7-1/2" W.

Part Number	Each Per Pack	Packs Per Case
051131-02506	10	1

3M™ Intake System Cleaner Point of Purchase Display

- Contains the following:
 - 1 3M™ Intake System Cleaner shop poster.
 - 1 3M™ Intake System Cleaner counter stand.
 - 50 3M™ Intake System Cleaner brochures.
 - 1 3M™ Intake System Cleaner counter mat.

Part Number	Quantity Per Case
051131-02507	1

3M™ C.A.R.T.S.

- Three-shelf body shop cart.
- Eighteen gauge sturdy metal construction.
- Fourteen gauge uprights.
- Three large storage areas.
- 5" rubber caster wheels.
- Dimensions: 19-3/4" x 29-1/2" x 32"
- Epoxy powder coated for lasting durability.
- Cart capacity: 400 lbs.
- Some assembly required.



Part Number	Quantity Per Case
051131-02510	1

Shop Seat

- A work seat on wide track wheels including two storage trays (one that swivels) to hold tools and other items.
- Dimensions: 14-1/2" W x 19" D x 15-1/2" H.



Part Number	Quantity Per Case
051131-02512	1

3M™ P.A.R.T.S.

- Rounded corners on shelf and legs.
- Sixteen gauge steel tubular frame construction.
- Easily adjustable to four positions.
- Some assembly required.
- Dimensions (tabletop form): 30-1/2" W x 36" L x 34-1/4" H.
- Weight: 30-1/2 lbs.
- Maximum weight limit tabletop form: 200 lbs.



Part Number	Quantity Per Case
051131-02514	1

3M™ Fuel System Cleaner Point of Purchase Display

- Contains the following:
 - 1 3M™ Fuel System Cleaner shop poster.
 - 1 3M™ Fuel System Cleaner counter stand.
 - 50 3M™ Fuel System Cleaner brochures.
 - 1 3M™ Fuel System Cleaner counter mat.



Part Number	Quantity Per Case
051131-02515	1

Electrical Cable Ties

3M™ Cable Ties

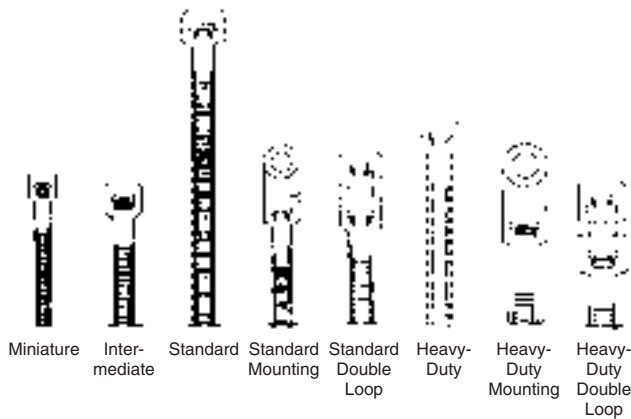

- Designed to meet a wide range of temperatures from -40°F (-40°C) to 185°F (85°C).
- Molded of one-piece nylon for durability with the locking head designed with a double tooth pawl for maximum security.
- Accommodates bundle diameters from 1/8" to 4".
- The perfect way to bundle hose, wire, cable or pipe to another bundle yet keeping them separate to prevent chafing.
- Available in natural or weather-resistant black for outdoor use.
- 3M™ Weather Resistant Cable Ties (Black) are specially designed for outdoor applications and they resist deterioration from ultraviolet light.

Part Number	Style	Length	Ties Per Bag	Bags Per Case
3M™ Weather Resistant Cable Ties — Black Bag				
054007-06200	Miniature	3-3/4"	100	10
054007-06201	Intermediate	5-7/8"	100	10
054007-06202	Standard	7-15/16"	100	10
054007-06203	Standard	12"	100	10
054007-06204	Standard	15"	100	5
054007-06205	Mounting	8-5/16"	100	10
054007-06207	Heavy-Duty	15"	100	5

Part Number	Style	Length	Ties Per Bag	Ties Per Case
3M™ Weather Resistant Cable Ties — Black Bulk				
054007-06270	Miniature	3-3/4"	1,000	10,000
054007-06271	Intermediate	5-7/8"	1,000	10,000
054007-06272	Standard	7-15/16"	1,000	10,000
054007-06273	Standard	12"	500	5,000
054007-06274	Standard	15"	500	2,500
054007-06275	Mounting	8-5/16"	1,000	10,000
054007-06277	Heavy-Duty	15"	500	2,500

3M™ Cable Ties (continued)



Part Number	Style	Length	Ties Per Bag	Bags Per Case
3M™ Cable Ties — Natural Bag				
054007-06224	Miniature	3-3/4"	100	10
054007-06225	Intermediate	5-7/8"	100	10
054007-06226	Standard	7-15/16"	100	10
054007-06227	Standard	12"	100	10
054007-06228	Standard	15"	100	5
054007-06232	Mounting	8-5/16"	100	10
054007-06234	Mounting	15-7/16"	50	10
054007-06240	Heavy-Duty	15"	100	5
054007-06243	Heavy-Duty Mounting	15-5/8"	50	10

Part Number	Style	Length	Ties Per Bag	Ties Per Case
3M™ Cable Ties — Natural Bulk				
054007-06248	Miniature	3-3/4"	1,000	10,000
054007-06249	Intermediate	5-7/8"	1,000	10,000
054007-06250	Standard	7-15/16"	1,000	10,000
054007-06251	Standard	12"	500	5,000
054007-06252	Standard	15"	500	2,500
054007-06256	Mounting	8-5/16"	1,000	10,000
054007-06258	Mounting	15-7/16"	500	2,500
054007-06264	Heavy-Duty	15"	500	2,500
054007-06267	Heavy-Duty Mounting	15-5/8"	500	2,500

† Double Loop

Electrical Cable Ties

3M™ Cable Tie Assortment Pack

- Use 3M™ Cable Ties with confidence when you secure wire bundles, harnesses and components.
- Allows you to slip ties easily under and around wires, cables and harnesses.
- Convenient assortment pack provides 100 ties of the most popular lengths.
- Assortment includes three sizes, four lengths, and natural and black colors.



Part Number	Ties Per Bag	Bags Per Case
054007-06220	100	10

Description	Length	Quantity	Type
Miniature	4"	15 Each	Natural
Miniature	4"	10 Each	Weather Res. Black
Intermediate	5"	15 Each	Natural
Intermediate	5"	10 Each	Weather Res. Black
Standard	7.5"	15 Each	Natural
Standard	7.5"	10 Each	Weather Res. Black
Standard	11"	15 Each	Natural
Standard	11"	10 Each	Weather Res. Black

Electrical Connectors

3M™ Scotchlok™ Bullet Receptacle Connector 901

- Quick connect/quick disconnect of the electrical systems of rental trailers, boats and boat trailers, campers, etc.
- No wire stripping — connects easily to any 14, 16 or 18 gauge copper wire operating at 48 volts or below.
- No special tools required.

Part Number	Product Number	Connectors Per Box	Boxes Per Case
Boxed			
054007-06106	901	50	10

Part Number	Product Number	Connectors Per Box	Connectors Per Case
Bulk			
054007-06107	901	500	5000

Electrical Connectors

3M™ Scotchlok™ Instant Auto-Electric Connector

- Make inline, pigtail and tap splices on solid or stranded wire with no wire stripping.
- Any auto, truck, boat, trailer or van wiring job can be installed faster and easier with a standard pair of pliers.



Part Number	Product Number	Color	Wire Range Tap-Run
054007-06119	902*	Brown	12 10
054007-06120			16 to 12 18
054007-06122	903*	Yellow	10 10
054007-06123			12 to 12
054007-06126	801*	Blue	14 14
054007-06127			16 to 16 18 18
054007-06128	905*	Red	14
054007-06129			18 to 16 22 18

* Listed by Underwriter's Laboratories.

Part Number	Product Number	Connectors Per Box	Boxes Per Case
Boxed			
054007-06119	902	50	10
054007-06122	903	50	10
054007-06126	801	50	10
054007-06128	905	50	10

Part Number	Product Number	Connectors Per Box	Connectors Per Case
Bulk			
054007-06120	902	1000	1000
054007-06123	903	1000	1000
054007-06127	801	500	5000
054007-06129	905	500	5000

3M™ Scotchlok™ Self-Stripping T-Tap Female QuickSlide Connector

- Makes midspan connection without stripping insulation.
- Provides disconnectable tap leg to simplify hookup, enhance flexibility.
- Ideal for taillight taps for trailer connections, and system taps for CB's, radar detectors, accessory lights, etc.
- Provides fully-insulated connection when used with 3M™ Scotchlok™ Fully Insulated Male Terminal (PNs 06152-06154).

Part Number	Product Number	Con-nectors Per Box	Boxes Per Case	Mates With PN
Boxed				
054007-06141	951	50	10	06154
054007-06144	952	50	10	06152
054007-06150	953	50	10	06153

3M™ Scotchlok™ Self-Stripping T-Tap Female QuickSlide Connector (continued)

Part Number	Product Number	Con-nectors Per Box	Con-nectors Per Case	Mates With PN
Bulk				
054007-06142	951	500	5000	06154
054007-06145	952	500	5000	06153
054007-06151	953	500	5000	06152

3M™ Scotchlok™ Electrical Connector 314

- Grease filled. Protects against corrosion in damp conditions.
- Handles 22-14 AWG solid or stranded wire.
- Self-stripping "U" contacts for mechanical strength and electrical conductivity.



Part Number	Connectors Per Box	Boxes Per Case
Boxed		
054007-09230	50	10
Part Number	Connectors Per Bag	Bags Per Case
Bulk		
054007-09231	1,000	1

3M™ Scotchlok™ Electrical Spring Connector Types Y, R, B & G

- Compact, flexible outer jacket.
- Corrosion resistant inner shell.
- "Live" inner spring grips wires and resists vibration.
- U.L. listed.



Part Number	Type	Wire Gauge	Connectors Per Box	Boxes Per Case
Boxed				
054007-42033	B	12-6	50	10
Part Number	Type	Wire Gauge	Connectors Per Box	Connectors Per Case
Bulk				
054007-15769	Y	18-12	500	10,000
054007-70488	G	14-8	500	2,500
054007-70489	R	16-10	500	5,000

Electrical Terminals

3M™ Scotchlok™ Deluxe Terminal Box and Assortment Kit

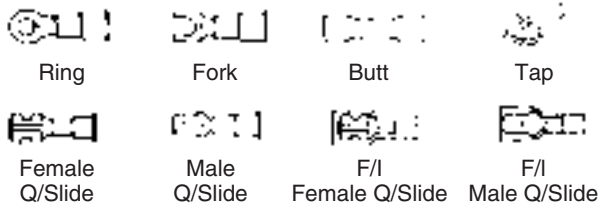

- A 24 compartment red and white metal box imprinted with “3M™ Scotchlok™ Terminals.” The compartments will contain 737 of the 24 most popular insulated terminals as follows:

Part Number	Type	Number of Pieces
054007-11914	Ring	10
054007-11915	Ring	10
054007-11921	Ring	30
054007-11922	Ring	50
054007-11923	Ring	30
054007-11924	Ring	20
054007-11932	Ring	20
054007-11934	Ring	20
054007-11935	Ring	70
054007-11920	Butt	50
054007-11928	Butt	100
054007-11939	Butt	50
054007-11926	Fork	10
054007-11927	Fork	20
054007-11918	Fork	10
054007-06126	Tap	27
054007-22997	Male Q/Slide	50
054007-22880	Female Q/Slide	100
054007-06152	F/I Male Q/Slide	10
054007-11960	F/I Female Q/Slide	10
054007-11822	Male Q/Slide	10
054007-11820	Female Q/Slide	10
054007-11919	Fork	10
054007-11913	Ring	10

Part Number	Description	Each Per Case
054007-06160	Kit	1

3M™ Scotchlok™ Terminal Box



- A red metal 17 slot or 24 slot box to hold your 3M™ Scotchlok™ terminals.
- **NOTE: TERMINALS ARE NOT INCLUDED WITH THE BOX.**

Part Number	Dimensions	Slots	Each Per Case
054007-11900	13.5" x 9.5" x 2"	17	6
054007-06161	18" x 12" x 3"	24	1

Electrical Crimping Tools

3M™ Scotchlok™ Crimping Tool TH-450



- Most versatile and heavy-duty tool.
- Made of high-strength, heat-treated carbon steel.
- Handles a variety of terminal and conductor styles including flags, closed-end connectors, crimp sleeves and standard parts both insulated and non-insulated.
- Connections are U.L. approved when the crimping process is completed and the tool releases.

Part Number	Wire Range	Quantity Per Case
054007-13760	26-6 AWG	10

3M™ Scotchlok™ Crimping Tool TH-440



- High-carbon, heat-treated steel and unique design provide a high-strength/weight ratio, durability, reliability and wide range of applications.
- Crimps a broad range of 22-10 AWG terminals and connectors.

Part Number	Wire Range	Tools Per Carton	Tools Per Case
054007-60825	22-10 AWG	1	10

Electrical Wire Marker Products

3M™ ScotchCode™ Wire Marker Tape Dispenser

- Provides a fast, convenient system for marking wire, cable, or vacuum hoses and spark plug wires.
- Special end loop to hook on belt or tool pouch.
- Small size makes it easy to carry.



Part Number	Each Per Box	Each Per Case
-------------	--------------	---------------

Filled Number Dispenser

054007-12174	1	25
054007-49518	1	10

Filled Color-Coded Dispenser

054007-49517	1	10
--------------	---	----

Empty Dispenser for Numbers or Colors

054007-49519	1	10
--------------	---	----

3M™ ScotchCode™ Wire Marker Tape — Numbered

- Epoxy, non-smear film.
- Acrylic adhesive system results in a superior oil/solvent resistance.
- Pre-Printed numbers 0 to 9.
- Smooth surface of this tape allows dirt and grime to be easily wiped off, providing text legibility even after extended exposure.
- Tape can be used for applications involving operating temperatures between -40°F to 250°F.

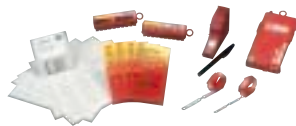

Part Number	Number On Roll	Rolls Per Case
054007-09368	0 thru 9 †	10
054007-09369	0	10
054007-09370	1	10
054007-09371	2	10
054007-09372	3	10
054007-09373	4	10
054007-09374	5	10
054007-09375	6	10
054007-09376	7	10
054007-09377	8	10
054007-09378	9	10

† Contains one roll of each number.

3M™ ScotchCode™ Wire Marker Tape — Colored

- An epoxy coated, non-smear film.
- Available in a variety of colors.
- The acrylic adhesive system results in a superior oil/solvent resistance.
- Truly one tape for all marking jobs.
- Smooth surface of this tape allows dirt and grime to be easily wiped off, providing text legibility even after extended exposure.
- Tape can be used for applications involving operating temperatures between -40°F to 250°F.



Part Number	Color	Rolls Per Case
054007-09404	Assortment †	10
054007-09423	Black	10
054007-09424	Blue	10
054007-09425	Brown	10
054007-09426	Green	10
054007-09427	Gray	10
054007-09428	Orange	10
054007-09429	Red	10
054007-09430	White	10
054007-09431	Yellow	10
054007-09458	Violet	10

† Contains one roll of each color.

Electrical Fuse Holder

3M™ Scotchlok™ Auto Fuse Holder

- In-line fuse holder.
- Designed to accommodate blade-type automotive fuses.
- Eliminates need for supplemental connectors.
- Reduces installation costs.

Part Number	Product Number	Holders Per Box	Boxes Per Case
Boxed			
054007- 06171	972	25	10

Part Number	Product Number	Holders Per Case
Bulk		
054007- 06172	972	1000

Heat Shrink Tubing

3M™ Heat Shrink Tubing Kit FP301

- A versatile assortment of flexible polyolefin heat shrink tubing in a variety of sizes and colors.



- Seven colors: Black, White, Clear, Red, Blue, Yellow, Green

• Kit contents:

3/32" (2,36 mm)	5 each of 7 colors	35 pieces
1/8" (3,18 mm)	4 each of 7 colors	28 pieces
3/16" (4,75 mm)	3 each of 7 colors	21 pieces
1/4" (6,35 mm)	3 each of 7 colors	21 pieces
3/8" (9,53 mm)	2 each of 7 colors	14 pieces
1/2" (12,70 mm)	2 each of 7 colors	14 pieces

Part Number	Kit Contents	Kits Per Case
051135- 37677	133 pieces, 6 sizes, 7 colors	5

3M™ Heat Shrink Tubing Refill Packs FP301



Part Number	Refill Pack Contents	Packs Per Case
051135- 36618	3/32" (2,36 mm) 35 pieces, 7 colors	10
051135- 36619	1/8" (3,18 mm) 28 pieces, 7 colors	10
051135- 36620	3/16" (4,75 mm) 21 pieces, 7 colors	10
051135- 36621	1/4" (6,35 mm) 21 pieces, 7 colors	10
051135- 36622	3/8" (9,53 mm) 14 pieces, 7 colors	10
051135- 36623	1/2" (12,70 mm) 14 pieces, 7 colors	10

Heat Shrink Tubing

3M™ Heat Shrink Tubing Kit EPS-300

- Assortment of adhesive-lined, flexible, polyolefin heat shrink tubing.
- Box is 7" x 11" x 2-1/2" of rugged translucent plastic.
- Installation information on the cover.
- Contains 42 pieces that are listed by expanded diameter:

EPS-300 Red	1/2"	12 — 6" pieces
EPS-300 Black	1/2"	12 — 6" pieces
EPS-300 Red	3/4"	6 — 6" pieces
EPS-300 Black	3/4"	6 — 6" pieces
EPS-300 Red	1"	3 — 6" pieces
EPS-300 Black	1"	3 — 6" pieces



3M™ Heat Shrink Tubing EPS-300

- All weather, dual wall, polyolefin tubing for automotive applications.
- Resistant to salt water, automotive fluids, solvents, fungus, punctures and corrosive chemicals.
- Heat shrinks rapidly to a skin-tight fit.
- Flame retardant.

Part Number	Size	Pieces Per Case	Suggested Wire Size Range
054007- 55916	1/2" x 48"	6	8 to 4 AWG
054007- 55918	3/8" x 48"	10	12 to 8 AWG
054007- 55919	1/4" x 48"	15	16 to 10 AWG

Part Number	Kits Per Case
051135- 38444	5

3M™ Heat Shrink Tubing Refill Packs EPS-300

- 6" Adhesive-lined, flexible, polyolefin heat shrink tubing.

Part Number	Color	Size	Pieces Per Bag	Bags Per Case
051135- 36592	Black	3/16"	24	10
051135- 36593	Black	1/4"	20	10
051135- 36594	Black	3/8"	16	10
051135- 36595	Black	1/2"	14	10
051135- 36596	Black	3/4"	12	10
051135- 36597	Black	1"	8	10
051135- 36598	Black	1-1/2"	4	10
051135- 38441	Red	1/2"	14	10
051135- 38442	Red	3/4"	12	10
051135- 38443	Red	1"	8	10

Retail Electrical Products

3M™ Electrical Connectors, Crimp Type

- 3M™ Electrical Connectors are one-piece, burr-free.
- Made of annealed electrolytic copper for mechanical strength and maximum conductivity.
- Electro-tin plating guards against corrosion.
- U.L. listed.

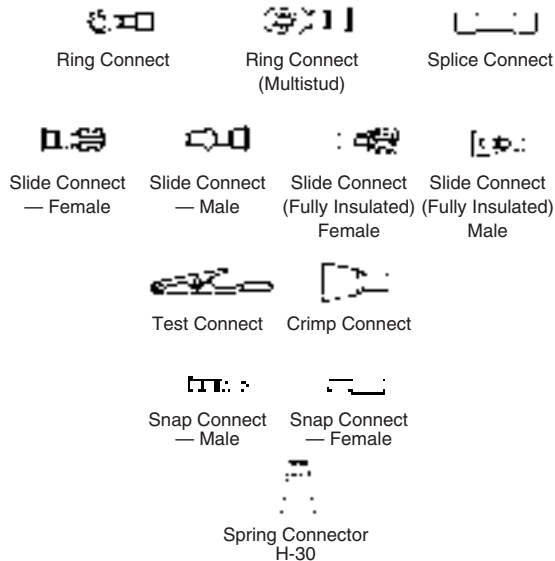

Part Number	Description	Wire Range	Stud Size	Qty. Per Pack	Packs Per Case
051131- 03738	Snap Connect- Male/Female	16-14	—	6	36
054007- 03754	Ring Connect (Multistud)	16-14	6-8-10	6	36
054007- 03768	Slide Connect- Female (Fully Insulated)	16-14	—	6	36
054007- 03784	Splice Connect	16-14	—	6	36
054007- 03785	Splice Connect	12-10	—	6	36
051131- 03801	Assorted Connects	16-14	—	48	6
051131- 03804	Assorted Connects	12-10	—	28	6
051131- 03858	Ring Connect	12-10	3/8"	9	36
051131- 03874	Quick-Connect	18-14	—	16	36
051131- 03884	Splice Connect	16-14	—	15	40
051131- 03983	Splice Connect	22-18	—	50	24
051131- 03984	Splice Connect	16-14	—	50	24
051131- 03985	Splice Connect	12-10	—	25	24

3M™ Insulation Displacement Connectors

- Packaged 6 packs per inner, 36 packs per case.

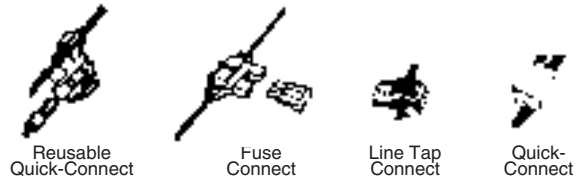

Part Number	Description	Wire Range	Quantity Per Pack
054007- 03774	Quick-Connect	18-14	3

Scotch-Brite™ Products



Products

Bench Motor Wheel	205
Clean & Strip Discs/Wheels	204 – 205
Disc Pad Assemblies	205
Gasket Removal Discs (Cookies) and Accessories	207
Hand Pads	203 – 205
Scotch-Brite™ Radial Bristle Discs	207
Retail Scotch-Brite™ Products	208
Rivet Cleaning Disc Wheels	203
Scotch-Brite™ Roloc™ Bristle Discs	206
Scuffing Discs, Pads, Rolls, Wheels	203 – 205
Surface Conditioning Discs	206

Scotch-Brite™ Products



Scotch-Brite™ Scuffing Discs, Pads, Rolls and Wheels

Scotch-Brite™ Rivet Cleaning Disc Brown



- Cleaning and sanding around rivet heads is fast and easy.
- Flexible three-dimensional construction allows abrasive to clean the surface without leveling the rivet head.
- Consistent performance for the life of the disc.
- No special tools; 3M™ Roloc™+ Holder (PN07500) fits standard tools and drill.
- Maximum operating speed 6000 RPM.
- Discs are used with 3M™ Roloc™+ Holder (PN07500).

Part Number	Size	Quantity Per Case
051131-07410	4" x 1-1/4"	10

Scotch-Brite™ Scuff Sponges



- Three-dimensional, non-woven material laminated to a cellulose sponge material conforms to work areas.
- Open construction reduces loading.
- Ideal for scuffing/cleaning on a variety of automotive surfaces.
- Flexible material that may be used wet or dry.
- Hand-held size offers convenience, comfort and reduces waste.
- Designed to be used in hard to reach areas.
- Available in three grades to cover a wide variety of jobs.
 - Scotch-Brite™ Clean & Prep Scuff Sponge (PN07439) is a white, buff finish sponge ideally suited for clean and prep applications, sensitive clear coat scuffing and parts cleaning, and cleaning leather and vinyl.
 - Scotch-Brite™ General Purpose Scuff Sponge (PN07441) is a maroon, medium finish sponge suited for primer scuffing and aggressive parts cleaning, and tire and whitewall cleaning.
 - Scotch-Brite™ Ultra Fine Scuff Sponge (PN07442) is a gray, fine finish sponge to be used for clear coat scuffing and fine parts cleaning.

Part Number	Desc.	Finish	Color	Sponges Per Bag	Sponges Per Case
051131-07439	Clean & Prep	Buff	White	10	30
051131-07441	General Purpose	Medium	Maroon	10	30
051131-07442	Ultra Fine	Fine	Gray	10	30

Scotch-Brite™ General Purpose and Ultra-Fine Scuffing Wheels



- Constructed of a durable, three-dimensional non-woven material.
- Flexible and ideal for machine scuffing/cleaning of hard-to-reach areas.
- The 3M™ Roloc™+ Holder (PN07500) allows for easy changeover of discs.

Part Number	Color	Size	Quantity Per Box	Boxes Per Case
051131-07443	Maroon	4" x 1-1/8"	10	1
		General Purpose		
051131-07444	Gray	4" x 1-1/8"	10	1
		Ultra Fine		

Scotch-Brite™ Light-Duty Cleansing Pad White



- Use on panel prior to clear coat blending.
- Conformable.
- Open web non-loading construction.
- Easily cleaned and used again.
- Pad size 6" x 9".

Part Number	Pads Per Box	Boxes Per Case
051131-07445	20	3

Scotch-Brite™ General Purpose Pad Maroon



- For scuffing before applying paint and primer-surfacer.
- For used car reconditioning, cleaning upholstery, headliners, doorpads, chrome and cleaning of white wall tires.
- Made of nylon web.
- Rinse clean.
- Can be used over and over again.
- Pad size 6" x 9".

Part Number	Pads Per Box	Boxes Per Case
051131-07447	20	3

Scotch-Brite™ Ultra Fine Pad Gray



- For final sanding of primer-surfacer.
- Made of nylon web.
- Rinse clean.
- Can be used over and over again.
- Pad size 6" x 9".

Part Number	Pads Per Box	Boxes Per Case
051131-07448	20	3

Scotch-Brite™ Multi-Flex Gold Abrasive Sheet Rolls

- Finest grade of Scotch-Brite™ Multi-Flex products for scuffing sensitive "blend" areas such as metallic paints.
- Excellent conformability for scuffing corners and other tight areas.
- Perforated sheet rolls for easy dispensing.
- Comes in 8" x 20' roll with 4" x 8" perforated sheets.

Part Number	Grade/Color	Sheets Per Roll	Rolls Per Case
051131-07523	A-ULF Ultra Fine Gold	60	4

Scotch-Brite™ Scuffing Discs, Pads, Rolls and Wheels

Scotch-Brite™ Multi-Flex Abrasive Sheet Rolls

- Thin, ultra-conformable, extra sharp and economical Scotch-Brite™ Sheets.
- Quick scuffing of irregular surfaces.
- Non-leveling, reusable, use wet or dry.
- Easy pop-up dispenser center-pull roll.
- Scrunches into a ball, like steel wool, to protect hands.
- Comes in 8" x 20' roll with 4" x 8" perforated sheets.
- Use Scotch-Brite™ General Purpose Grade Maroon/Purple Abrasives (PN07521) in these applications:
 - Quick scuffing of irregular surfaces.
 - Super sharp, use where aggressive scratch is acceptable.
 - Scuffing prior to primer and primer surfaces.
 - Cleaning of whitewalls and engine parts.
 - Scuffing of new parts, door jambs and under hood webs.
- Use Scotch-Brite™ Ultra Fine Grade Gray Abrasives (PN07522) in these applications:
 - Aggressive scuffing of blend areas.
 - Extra sharp for fast surface preparation prior to paint.
 - Final scuffing of primer.



Part Number	Grade/Color	Sheets Per Roll	Rolls Per Case
051131-07521	A-VFN General Purpose Maroon/Purple	60	4
051131-07522	S-UFN	60	4

3M™ Scuff-It™ Paint Prep Gel

- Use with either 3M™ Clear Prep Scuff (PN07745) or 3M™ Color Prep Scuff (PN07748).
- Cleans, degreases and abrades surface prior to paint.
- Ideal for prepping panels for paint and blend areas.
- Use for prepping plastic and rubber parts.
- Rinses off with water; no residue.
- Safe to use around moldings, door handles and door jambs.

Part Number	Tube Size	Tubes Per Case
051131-06013	24.7 oz.	6

3M™ Clear Blend Prep Scuff

- Excellent for sail panel blends.
- Perfect for gold/silver/pearl metallic.
- Prep clear coat areas and critical blends.
- Easy "buff back."
- Provides optimum clear prep adhesion.



Part Number	Size	Color	Rolls Per Case
051131-07745	4-3/4" x 15'	Gold	3

3M™ Primer Prep Scuff

- Prep E-coated panels quickly.
- Scuffs faster without leveling.
- Use on door jambs and underneath hoods.
- Provides optimum primer prep adhesion.



Part Number	Size	Color	Rolls Per Case
051131-07747	4-3/4" x 15'	Maroon	3

3M™ Color Prep Scuff

- Ideal for use on all panels.
- Scuffs faster and finer.
- Use for prep of color-coat areas and easy blends.
- Provides for optimum color prep adhesion.



Part Number	Size	Color	Rolls Per Case
051131-07748	4-3/4" x 15'	Gray	3

Scotch-Brite™ Clean & Strip Disc Black

- Open mesh disc made from a tough, abrasive impregnated material.
- Perfect alternative to wire brushes for tough cleanup jobs on almost any type of surface.
- Disc is used with 3M™ Wheel Mandrel (PN07491).



Part Number	Size	Discs Per Bag	Bags Per Case
051131-07460	4" x 1/4"	10	3

Scotch-Brite™ Roloc™ Coating Removal Disc Black

- Tough, open, virtually non-loading web makes surface preparation fast and easy.
- Great for removal of undercoatings, stone guards, seam sealers and rust.
- Works well under hood webs, in truck beds, door jambs, under carriage and wheel wells.
- Useful in tire shops to remove oxidation from rims.
- Eliminates slow leaks due to oxidation and/or corrosion.
- Used for removal of rust from brake assemblies.
- Discs used with 3M™ Roloc™+ Holder (PN07500).



Part Number	Size	Discs Per Box
051131-07461	3"	10

Scotch-Brite™ Roloc™ + Clean & Strip Disc Black

- Aggressively removes paint and rust from seams, door jambs, drip moldings, pinch-welds and other difficult-to-reach areas.
- Three-dimensional abrasive web conforms to work area.
- Safer than wire bristle tools.
- Durable web design lasts longer and will not rust.
- Maximum operating speed 8000 RPM.
- Disc is used with 3M™ Roloc™+ Holder (PN07500).



Part Number	Size	Discs Per Box
051131-07466	4" x 1/2"	10

Scotch-Brite™ Scuffing Discs, Pads, Rolls and Wheels

Scotch-Brite™ Scuffing Discs

- Constructed of a durable, three-dimensional, non-woven Scotch-Brite™ web.
- Designed to be used in conjunction with the 3M™ Hookit™ Disc Pad for 6" Discs (PN05776) on a random orbital sander.
- Offers a quicker, more efficient method of machine scuffing automotive finishes.



Part Number	Size/Grade	Color	Discs Per Box	Boxes Per Case
051131-07467	6" General Purpose	Maroon	10	4
051131-07468	6" Ultra Fine	Gray	10	4
051131-07469	3" General Purpose	Maroon	25	4
051131-07472	3" Ultra Fine	Gray	25	4

Scotch-Brite™ Roloc™ + Clean & Strip XT Disc Purple

- Durable, three-dimensional web aggressively removes paint, rust and seam sealer in hard-to-reach areas.
- Long-lasting disc is effective on jagged and sharp surfaces where other discs wear out.
- Safer than wire sheets and will not rust.
- Maximum operating speed 8500 RPM.

Part Number	Size	Discs Per Case
051131-07470	4" x 1/2"	10

Scotch-Brite™ Clean & Strip XT Disc Purple

- Stronger and tougher than the Scotch-Brite™ Clean & Strip Disc (PN07460) for uniform disc wear and longer life. (For added conformability and flexibility use PNs 07460 or 07466.)
- Will not rust.
- Use this disc with 3M™ Wheel Mandrel (PN07491).
- Maximum operating speed 8500 RPM.

Part Number	Size	Discs Per Bag	Bags Per Case
051131-07471	4" x 1/4"	4	6

3M™ Wheel Mandrel

- For use with Scotch-Brite™ Clean & Strip Disc (PN07460).
- Mandrel size is 2" long with 1/4" shank.



Part Number	Each Per Bag	Bags Per Case
048011-07491	1	1

Scotch-Brite™ Bench Motor Wheel

- Excellent when used on a bench motor to clean, deburr, blend, finish or polish all types of metals, composites or plastics.



Part Number	Each Per Case
051131-07744	5

Scotch-Brite™ Imperial™ Paint Prep Scuff Maroon

- Fastest, easiest way to get ready for paint/primer.
- Promotes better paint adhesion.
- Perforated; use in convenient hand-size pad or full-size.
- Tough use over and over.



Part Number	Scuffs Per Box	Boxes Per Case
051131-07777	20	3

3M™ Roloc™ Disc Pad Assembly

- Hard rubber backup pad.
- Provides firm support for Scotch-Brite™ Roloc™ Surface Conditioning Discs and 3M™ Roloc™ Bristle Discs.
- Pad assemblies come complete with a 2" steel shaft and adapter.



Part Number	Diameter	Shaft	Quantity Per Case
051131-05538	1"	1/4" Diameter	10
051144-05539	2"	1/4" Diameter	10
051144-05540	3"	1/4" Diameter	10
051131-05541	4"	1/4" Diameter	10

Scotch-Brite™ Surface Conditioning/ Roloc™ Bristle Discs and Accessories

Scotch-Brite™ Surface Conditioning Discs

- Used to quickly remove cut cork or paper gaskets and form-in-place gasketing materials prior to the assembling of power train components.
- Ideal for cleaning light oxidation and removing gasketing residue.
- Use on a wide variety of surfaces, including engine blocks, heads, valve covers and transmission housing.
- Use with Scotch-Brite™ Surface Conditioning Disc Pads (PNs 07492-07494).



Part Number	Grade/ Color	Size	Discs Per Box	Boxes Per Case
For Steel Parts				
051131-07450	Coarse/Brown	4" x NH	10	4
051131-07451	Medium/Maroon	4" x NH	10	4
051131-07455	Coarse/Brown	3" x NH	25	4
051131-07456	Medium/Maroon	3" x NH	25	4
051131-07453	Coarse/Brown	2" x NH	25	4
051131-07457	Medium/Maroon	2" x NH	25	4
For Aluminum Parts				
051131-07504	Medium (VFN) Blue	4" x NH	10	4
051131-07505	Fine (SFN) Gray	4" x NH	10	4
051131-07506	Medium (VFN) Blue	3" x NH	25	4
051131-07507	Fine (SFN) Gray	3" x NH	25	4
051131-07508	Medium (VFN) Blue	2" x NH	25	4
051131-07509	Fine (SFN) Gray	2" x NH	25	4

Scotch-Brite™ Disc Pad

- Connects quickly and easily to any power tool.
- Holds Scotch-Brite™ Surface Conditioning Discs securely and safely through the use of 3M™ Scotchmate™ Dual Lock™ Fastening System.



Part Number	Size	Quantity Per Case
048011-07492	For 4" Discs	5
051131-07493	For 3" Discs	10
048011-07494	For 2" Discs	10

Scotch-Brite™ Roloc™ Surface Conditioning Discs

- Quick 1/2 turn on, 1/2 turn off.
- Use with 3M™ Roloc™ Disc Pad Assembly (PNs 05539-05541).
- Used to quickly remove cut cork or paper gaskets and form-in-place gasketing materials prior to the assembling of power train components.



Part Number	Color	Size/ Grade	Discs Per Box	Boxes Per Case
For Steel Parts				
051131-07480	Brown	2" Coarse	25	4
051131-07481	Maroon	2" Medium	25	4
051131-07482	Brown	4" Coarse	10	10
051131-07483	Maroon	4" Medium	10	10
051131-07485	Brown	3" Coarse	25	4
051131-07486	Maroon	3" Medium	25	4
For Aluminum Parts				
051131-07511	Blue	4" Medium (VFN)	10	10
051131-07512	Gray	4" Fine (SFN)	10	10
051131-07513	Blue	3" Medium (VFN)	25	4
051131-07514	Gray	3" Fine (SFN)	25	4
051131-07515	Blue	2" Medium (VFN)	25	4
051131-07516	Gray	2" Fine (SFN)	25	4

Scotch-Brite™ Roloc™ Bristle Discs

- Super tough plastic bristle brush, embedded with abrasive.
- Wears as it cleans, continually exposing fresh abrasive.
- The ideal tool to replace scrapers, wire wheels and chemical gasket stripper.
- Eliminates the danger of loose wires flying back at operator.
- Safer for parts and the environment than hazardous chemical strippers.
- Maximum operating speeds (M.O.S.) allow for use on both die grinders and pistol grip grinders.
 - 1" Disc MOS = 30,000 RPM
 - 2" Disc MOS = 25,000 RPM
 - 3" Disc MOS = 18,000 RPM
- Use green on steel parts and yellow or white on aluminum parts for quick and safe removal.
- Bristles ride over surface cleaning contaminants without gouging surface.
- Use with 3M™ Roloc™ Disc Pad Assemblies (PNs 05538, 05539 and 05540).

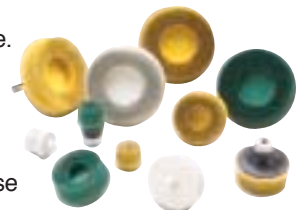

Part Number	Grade	Color	Size	Discs Per Box	Boxes Per Case
051131-07524	50	Green	2"	10	4
051131-07525	80	Yellow	2"	10	4
051131-07526	50	Green	3"	10	4
051131-07527	80	Yellow	3"	10	4
051131-07528	120	White	2"	10	4
051131-07529	120	White	3"	10	4
051131-07530	50	Green	1"	10	4
051131-07531	80	Yellow	1"	10	4
051131-07532	120	White	1"	10	4

Gasket Removal Discs and Accessories

Scotch-Brite™ Roloc™ Gasket Removal Discs

- Designed specifically for use on metal automotive engine and drive train parts where a less aggressive disc is needed.
- Does not remove metal from the surface of engine parts.
- Does not contaminate inner engine parts with loose aluminum oxide abrasive.
- Can be used on aluminum and cast iron automotive parts for cleaning parts prior to reapplying gasket material.
- Gasket removal disc should be used with a 3M™ Roloc™ Disc Pad (PNs 05539 or 05540).

Part Number	Size	Maximum Operating Speed	Discs Per Box	Boxes Per Case
051131- 07474	2"	25,000 RPM	10	10
051131- 07475	3"	18,000 RPM	10	10

Scotch-Brite™ Radial Bristle Discs

- 3" diameter x 3/8" center hole.
- Unique bristle pattern reaches tight or awkward areas such as grooves and along 90° angles.
- Flexible bristles conform to the part and cleans without removing base material.
- Helps to reduce damage and rework.
- Higher cut rate than wire brushes for faster, more uniform finish.
- Applications include:
 - Removal of adhesive, paint, oxidation and other coatings.
 - Clean and prepare surfaces before and after welding.
 - Remove gasket materials from recessed areas.
 - Remove O-ring residue.



Part Number	Size	Grade	Discs Per Box	Boxes Per Case
051131- 07542	3"	50	10	4
051131- 07543	3"	80	10	4
051131- 07544	3"	120	10	4

3M™ 990 Mandrel

- Designed for use with the 3" x 3/8" Radial Bristle Discs (PNs 07542, 07543 and 07544).
- Allows stacking of one to four discs.

Part Number	Size	Quantity Per Case
048011- 15012	1-3/4" x 1/4" mandrel shank size and 3/8" center hole	5

Scotch-Brite™ Gasket Removal Disc

- Made of non-woven nylon fiber material impregnated with aluminum oxide material.
- Ideal for removing old gasketing residue and preparing the surface for a new gasket, whether it be form-in-place, composite or paper.
- Can be used on cast or aluminum surfaces without damage.
- Uses 3M™ Scotchmate™ Fastening System (Hook-and-Loop design).
- Peggable package for easy display.



Part Number	Size	Grade	Color	Discs Per Pack	Packs Per Case
051131- 07705	2"	Medium	Maroon	6	5

Retail Scotch-Brite™ Products

3M™ Drill Mounted Automotive Grinding/Sanding/Finishing System

- 2" Grinding Discs are great for hard-to-reach areas.
- 3M™ Regalite™ Discs grind through paint, primer, filler and rust.
- Scotch-Brite™ Discs are outstanding for gasket removing, disc brake finishing and metal polishing.



Part Number	Description	Quantity Per Pack	Packs Per Case
051131-03050	Finishing Kit 1 — 2" Disc Holder, 3 — 2" 3M™ Regalite™ Sanding Discs 2 — 2" Scotch-Brite™ Discs	1 Kit	6
051131-03051	2" Disc Holder	1 Holder	10
051131-03055	Scotch-Brite™ Polishing Discs Fine	3 Discs	10
051131-03057	Scotch-Brite™ Stripping Discs Coarse	3 Discs	10

3M™ Automotive Rust & Paint Stripper

- Removes rust, scale and old paint from metal.
- Attaches easily to an electric drill.
- Made from tough, non-woven synthetic material.
- Flexible — won't rust or splinter.
- Can also be used for sanding wood, fiberboard and plastics.



Part Number	Size	Packs Per Case
051131-03171	4" Diameter	24

3M™ Heavy-Duty Automotive Rust & Paint Stripper

- Double-thick Scotch-Brite™ web strips are quicker, last longer and cut faster.
- Conforms to surface contours.
- Attaches easily to a standard electric drill.



Part Number	Description	Packs Per Case
051131-03172	4" Diameter	10

Body Repair



Products

Accessories	214
Body Fillers	211-212
Dry Guide Coat	214
Putties (One-Part or Two-Part)	212-213
Resins	213

Body Repair



Body Repair — Fillers

3M™ Lightweight Body Filler

- Tack-free.
- Cures tack-free in 15–20 minutes — reduces sandpaper loading.
- Creamy texture.
- Smooth spreading.
- Easy sanding.
- Vacuum processed to minimize pinholes.



Part Number	Size/Net Wt.	Units Per Case
051131-05800	Quart (2 lbs./32 oz.)	6
051131-05801	Gallon (7.75 lbs./124 oz.)	4
051131-05804	5 Gallon Pail †† (37.5 lbs.)	1
051131-05805	5 Gallon Pail † (37.5 lbs.)	1

† To be used with Mechanical Dispensers.
†† To be used with Air-Operated Dispensers.

3M™ Premium Lightweight Body Filler

- Tack-free and stain resistant.
- For base coat/clear coat refinishing systems.
- Ultra creamy.
- Cures tack-free in 15–20 minutes — reduces sandpaper loading.
- Easiest sanding 3M™ Body Filler.
- Minimizes staining that can occur with base coat/clear coat systems over body filler.
- Vacuum processed to minimize pinholes.

Part Number	Size/Net Wt.	Units Per Case
051131-05808	Gallon (7.75 lbs./124 oz.)	4
051131-05810	5 Gallon Pail † (37.5 lbs.)	1

† To be used with Air-Operated Dispensers.

3M™ Long Strand Fiberglass Reinforced Filler

- Contains long strands of fiberglass.
- Repairs holes, cracks and tears in fiberglass.
- Repairs holes in metal.
- Waterproof.
- Repairs larger holes, cracks and tears better than 3M™ Short Strand Fiberglass Reinforced Filler (PNs 05815-05816).



Part Number	Size/Net Wt.	Units Per Case
051131-05814	Gallon (10.5 lbs./168 oz.)	4

3M™ Short Strand Fiberglass Reinforced Filler

- Contains chopped fiberglass.
- Repairs holes, cracks and tears in fiberglass.
- Repairs holes in metal.
- Smooth spreading.
- Waterproof.
- Can be used with 3M™ Fiberglass Mat (PN05837) or 3M™ Fiberglass Cloth (PN05838) to reinforce large repair areas.



Part Number	Size/Net Wt.	Units Per Case
051131-05815	Quart (2.6 lbs./41.6 oz.)	6
051131-05816	Gallon (10.5 lbs./168 oz.)	4

3M™ Sprayable Polyester Filler

- Fills grade 36 sand scratches.
- May be wet or dry sanded in 45 minutes.
- Easily applied with primer gun.
- Helps eliminate staining that can occur with base coat/clear coat systems over body filler.
- Non-isocyanate.



Part Number	Size/Net Wt.	Units Per Case
051131-05825	Quart (2.6 lbs./41.6 oz.)	6
051131-05826	Gallon (10.5 lbs./168 oz.)	4

3M™ Premium Body Filler Gold QBA

- Quick build adhesion.
- A premium gold lightweight body filler for filling low areas in damaged automotive sheet metal.
- Builds adhesion faster than other 3M™ Fillers.
- Contains zinc complex.
- Tack-free and stain resistant.
- Lightweight body filler for base coat/clear coat refinishing systems.
- Cures tack-free in 20 minutes.
- Minimizes staining that can occur with base coat/clear coat systems over body and filler.
- Vacuum processed to minimize pinholes.
- Excellent adhesion to galvanized steel, SMC and aluminum.
- Distinctive gold color.



Part Number	Size/Net Wt.	Units Per Case
051131-05835	Gallon (7.75 lbs./124 oz.)	4
051131-05839	3 Gallon Pail † (22.5 lbs.)	1
051131-05840	5 Gallon Pail †† (37.5 lbs.)	1
051131-05841	5 Gallon Pail † (37.5 lbs.)	1

† To be used with Mechanical Dispensers.
†† To be used with Air-Operated Dispensers.

Body Repair — Fillers

3M™ Zebra™ Advanced Lightweight Filler

- A two-component body filler designed to fill low areas in damaged automotive sheet metal.
- Sands better than traditional lightweight fillers.
- More stain-resisting power.
- Adheres to steel, SMC, galvanized steel and aluminum.
- Vacuum processed for fewer pinholes.
- Cures tack-free in approximately 20 minutes — reduces sandpaper loading.
- Advanced formulation.



Part Number	Container Size	Quantity Per Case
051131-05868	Gallon	4
051131-05870	3 Gallon Pail †	1
051131-05871	5 Gallon Pail ††	1

† To be used with Mechanical Dispensers.
 †† To be used with Air-Operated Dispensers.

Body Repair — Putties

3M™ Premium Polyester Finishing Putty

- Tack-free and stain resistant.
- Fills pinholes in body fillers and small imperfections in metal and fiberglass.
- Cures tack-free in 20–25 minutes.
- Extremely smooth sanding.
- Minimizes staining that can occur with base coat/clear coat systems over body filler.
- Vacuum processed to minimize pinholes.



Part Number	Size/Net Wt.	Units Per Case
051131-05819	1 Quart (2.25 lbs./36 oz.)	12

3M™ Piranha™ Advanced Finishing Putty

- Two-component, self-leveling putty designed for use as a “skin” coat over plastic filler to fill pinholes, sand scratches, low areas and other imperfections.
- Cures tack-free in 30 minutes.
- Grips tight to galvanized steel, sanded paint, aluminum, steel, SMC, and fiberglass.
- Extremely easy sanding.
- Flowable and brushable.
- Non-staining.



Part Number	Container Size	Quantity Per Case
051131-05821	24 fl. oz.	6

3M™ Flowable Finishing Putty

- Tack-free and stain resistant.
- Two-component, self-leveling putty designed for use as a “skin” coat over plastic filler to fill pinholes, sand scratches, low areas or other imperfections.
- Available in quart and handy squeeze dispenser — no mess.
- Fills pinholes in body fillers and small imperfections in metal and fiberglass.
- Cures tack-free in 30 minutes.
- Flowable, brushable.
- Easiest sanding 3M™ Polyester Putty.
- Minimizes staining that can occur with base coat/ clear coat systems over body filler.
- Vacuum processed to minimize pinholes.
- Excellent adhesion to galvanized steel, aluminum and thoroughly cured and sanded factory-applied paint surfaces.



Part Number	Size/Net Wt.	Units Per Case
051131-05824	Pint (1.03 pt./24 fl. oz.)	6

Body Repair — Putties

3M™ Acryl-Green Spot Putty

- Fast-drying, easy-sanding putty.
- Designed for spot repairs.
- Spreads easily.



Part Number	Size/Net Wt.	Tubes Per Case
051144-05960	21 oz. Tube	12

3M™ Acryl-Red Glazing Putty

- Good general purpose putty.
- Fills small pinholes and scratches.
- Fills larger areas of imperfections.



Part Number	Size/Net Wt.	Tubes Per Case
051144-05966	21 oz. Tube	12

3M™ Acryl-Blue Glazing Putty

- Slow-drying, easy-spreading putty.
- Recommended for filling minor low areas and deeper sand scratches.
- Provides more working time.



Part Number	Size/Net Wt.	Tubes Per Case
051144-05964	21 oz. Tube	12

3M™ Super Red Putty

- Self-leveling, easy to spread putty.
- Excellent glazing putty.
- Designed to flow into and fill pinholes and scratches.
- A nitrocellulose putty.
- “Long working time” with minimal shrinkage.
- Feathers out to a smooth surface.
- Flows out to eliminate ridges and squeegee lines.
- Sands easily, even after overnight drying.
- Cuts down on extra sanding steps.



Part Number	Size/Net Wt.	Tubes Per Case
051144-05972	21 oz. Tube	12

Body Repair — Resins

3M™ Blue Creme Hardener

- A creme hardening agent designed to be used with 3M™ Zebra™ Advanced Lightweight Fillers (PNs 05868, 05870 and 05871) and 3M™ Piranha™ Putty (PN05821).

Part Number	Size/Net Wt.	Tubes Per Case
051131-05766	2.75 oz. Tube	12

3M™ Creme Hardener

- Red creme hardening agent designed to be used with 3M™ Lightweight Body Filler (PNs 05800-05805), 3M™ Premium Lightweight Body Filler (PNs 05806-05811), 3M™ Premium Body Filler Gold QBA (PNs 05832-05841), 3M™ Long Strand Fiberglass Reinforced Filler (PNs 05813 or 05814), 3M™ Short Strand Fiberglass Reinforced Filler (PNs 05815 or 05816), 3M™ Polyester Finishing Putty (PNs 05817 or 05818), 3M™ Premium Polyester Finishing Putty (PNs 05819 or 05820), or 3M™ Flowable Finishing Putty (PN05823).
- Creamy consistency mixes easily and quickly with any of the above products.



Part Number	Size/Net Wt.	Units Per Case
051131-05830	2.75 oz. Tube	12

3M™ Fiberglass Resins

- Designed to be used with 3M™ Fiberglass Cloth (PN05838) and/or 3M™ Fiberglass Mat (PN05833) to patch holes in metal, and cracks, tears, punctures and splits in fiberglass panels.
- Waterproof when cured.
- 3M™ Liquid Hardener (PN05836) included.
- For metal and fiberglass.
- Thick formulation resists sags or runs.



Part Number	Size/Net Wt.	Units Per Case
051131-05833	Quart (1 Quart/32 fl. oz.)	12
051131-05834	Gallon (1 Gallon/128 fl. oz.)	4

3M™ Liquid Hardener

- Fast-acting liquid hardening agent designed to be used with 3M™ Sprayable Polyester Filler (PNs 05825 or 05826), and/or 3M™ Fiberglass Resin (PNs 05833 or 05834).



Part Number	Size/Net Wt.	Tubes Per Case
051131-05836	22cc Tube	12

Body Repair — Accessories

3M™ Fiberglass Mat

- Designed to be used with 3M™ Resin (PNs 05833 or 05834) or 3M™ Short Strand Fiberglass Reinforced Filler (PNs 05815 or 05816) to patch larger holes in metal, and cracks, tears, punctures and splits in fiberglass panels.
- For reinforcing fiberglass and metal repairs.
- Excellent for large repairs where extra reinforcement is needed.



Part Number	Size	Units Per Case
051131-05837	8 sq. ft.	6

3M™ Fiberglass Cloth

- Designed to be used with 3M™ Resin (PNs 05833 or 05834) or 3M™ Short Strand Fiberglass Reinforced Filler (PNs 05815 or 05816) to patch larger holes in metal, and cracks, tears, punctures and splits in fiberglass panels.
- For reinforcing fiberglass and metal repairs.
- Excellent for large repairs where extra reinforcement is needed.



Part Number	Size	Units Per Case
051131-05838	8 sq. ft.	6

3M™ Spreaders

- Designed for spreading body and fiberglass fillers, finishing putties, and resins.
- Sharp edge.
- Flexible.
- Durable.
- Easy to clean.
- Cured filler pops off easily.



Part Number	Size	Units Per Case
051131-05842	4"	50
051131-05843	5"	50
051131-05844	Assortment	24
	1 each — 4", 5" & 6"	

3M™ Dispenser Valve

- A plastic butterfly valve for use on 5 gallon containers of 3M™ Body Filler.



Part Number	Quantity Per Case
051131-05854	4

3M™ Dry Guide Coat Cartridge & Kit

- Method of identifying surface imperfections such as pinholes and deep scratches in primer.
- Requires no masking.
- No dry time involved.
- Can be used in both wet or dry sanding.
- Contains no solvents.
- Kit comes with applicator pad.



Part Number	Description	Quantity Per Case
051131-05860	50 Gram Cartridge	10
051131-05861	50 Gram Cartridge & Applicator Kit	6

Decorative, Protective, Reflective Products



Products

Accessories	231
Reflective Conspicuity Markings (Trailer Markings).....	217–218
Retail Reflective Products . . .	231
3M™ Scotchcal™ Signwriter Film	229
3M™ Scotchcal™ Striping Tapes	221–229
Scotchgard™ Paint Protection Film (PPF).....	220
3M™ Scotchlite™ Reflective Striping	230
Stripe/Molding Removal Products	219

Decorative, Protective, Reflective Products



3M Reflective Conspicuity Markings

3M™ Diamond Grade™ Conspicuity Markings

- Rolls are designed to mark the side and rear perimeter of trucks and trailers for enhanced visibility and detection.
- “Kiss Cut” rolls are conventional roll stock where the sheeting has been cut through to the liner for easy application.
- In compliance with NHTSA Ruling and DOT-C2 Certification.
- Guaranteed to meet and exceed NHTSA’s minimum specifications for seven years.
- All material is edge sealed.



Part Number	Description	Color	Roll Size	Rolls Per Case
Series 983/Rolls				
051138- 67533	983-32 ES	Red 11" White 7" Alternating	2" x 150'	1
051138- 67535	983-326 ES	Red 6" White 6"	2" x 150'	1
051138- 67537	983-10 ES	White	2" x 150'	1
051138- 67636	983-32 ES	Red 11" Kiss Cut 2" x 18" White 7" Alternating	2" x 150'	1
051138- 67639	983-10 ES	White	2" x 150'	1
	Kiss Cut 2" x 12"			
051135- 31031	983-326 ES	Red/White	2" x 150'	1
	Kiss Cut 2" x 12"			
051135- 31015	983-326 ES	Red/White	2" x 150'	6
	Kiss Cut 2" x 24"			
051138- 67764	983-32 ES	Red 11" White 7"	1-1/2" x 150'	1
051138- 67816	983-72 ES	Red	2" x 150'	1
051138- 67823	983-72 ES	Red	3" x 150'	1
051138- 67824	983-72 ES	Red	4" x 150'	1
051138- 67825	983-32 ES	Red 11" White 7"	4" x 150'	1
051138- 67826	983-10 ES	White	4" x 150'	1
051138- 67827	983-10 ES	White	3" x 150'	1
051138- 67828	983-32 ES	Red 11" White 7"	3" x 150'	1
Series 985/Rolls				
051135- 16242	985-10 ES	White	2" x 150'	1
051135- 16243	985-326 ES	Red 6" White 6"	2" x 150'	1
051135- 16244	985-32 ES	Red 7" White 11"	2" x 150'	1
051135- 16281	985-32 ES	Red/White	2" x 150'	1
	Kiss Cut 2" x 18"			
051135- 16282	985-326 ES	Red/White	2" x 150'	1
	Kiss Cut 2" x 12"			

3M™ Diamond Grade™ Conspicuity Markings (continued)

Part Number	Description	Color	Roll Size	Rolls Per Case
Series 983/Strips				
051138- 67635	983-32 ES	Red 11" 18" x 2" Strips White 7" Alternating	100	1
051138- 67638	983-10 ES	White	12" x 2" Strips 100	1
051135- 31019	983-326 ES	Red 6" 2" x 12" Strips White 6"	100	6

3M™ Diamond Grade™ Auto Reflective Trailer Marking Kit 983

- DOT-C2 Certified.
- Exceeds NHTSA requirements.
- Highly reflective, even up to a 90° angle.
- Quick and easy to apply.



Part Number	Kit Includes	Kits Per Case
051138- 67714	36 – 2" x 18" red and white reflective strips 4 – 2" x 12" white reflective strips 1 – 2" x 90" red and white reflective strip 1 – 1-1/2" x 90" red and white reflective strip Application instructions and squeegee Marks one vehicle up to 53 feet	1
051138- 67715	32 – 2" x 18" red and white reflective strips 4 – 2" x 12" white reflective strips 1 – 2" x 90" red and white reflective strip 1 – 1-1/2" x 90" red and white reflective strip Application instructions and squeegee Marks one vehicle up to 48 feet	1
051138- 67716	19 – 2" x 18" red and white reflective strips 4 – 2" x 12" white reflective strips 1 – 2" x 90" red and white reflective strip 1 – 1-1/2" x 90" red and white reflective strip Application instructions and squeegee Marks one vehicle up to 28 feet	1

Part Number	Color	Roll Size	Kits Per Case
051131- 06398	Alternating Red/White	2" x 25 yds.	1
051131- 06399	Alternating Red/White	2" x 50 yds.	1

3M Reflective Conspicuity Markings

3M™ Diamond Grade™ Conspicuity Discs

- 3" diameter discs are pressure-sensitive.
- In compliance with NHTSA Ruling and DOT-C2 Certification.
- Guaranteed to meet and exceed NHTSA's minimum specifications for seven years.

Part Number	Description	Color	Discs Per Pkg.	Pkg. Per Case
051138-22058	DGYC-3 3" Diameter PSA Discs	Yellow	25	1
051138-22059	DGRC-3 3" Diameter PSA Discs	Red	25	1
051138-22060	DGSC-3 3" Diameter PSA Discs	White	25	1

3M Stripe/Molding Removal Products

3M™ Stripe Off Wheel

- Used to remove vinyl decals, striping tapes, and double-sided foam attachment tapes.
- Will not scratch or damage acrylic enamel or urethane paint.
- Not for use on lacquer coatings.
- Designed to be used with common 3/8" pneumatic and electric tools with a 500–4000 RPM speed range.
- Optimum performance achieved around 2000+/-200 RPM.



Part Number	Description	Quantity Per Case
051131-07498	Includes attachment hardware	5
051131-07499	Does Not include hardware	5

3M™ Roloc™ + Holder

- Allows use of Scotch-Brite™ Molding Adhesive and Stripe Removal Discs (PNs 07501–07502) on your tool.
- The 1/4" shank fits into any recommended standard tool.
- Quick and easy to use.
- A simple twist and the disc is attached and ready to use.



Part Number	Size	Quantity Per Case
051131-07500	1" Dia. x 1/4" Shank	1

Scotch-Brite™ Molding Adhesive and Stripe Removal Disc

- Use to remove vinyl decals, graphics and striping tapes.
- Will not scratch or damage acrylic enamel or urethane paint.
- Long-lasting, unique construction provides optimum disc life.
- No sharp edges to cause damage to surfaces.
- Discs must be run on tools that have proper speed ratings.
 - Required tool speed for 4" disc is 4000 RPM.
 - Required tool speed for 6" disc is 2800 RPM.



Part Number	Size	Quantity Per Case
051131-07501	4" Dia. x 3/8"	5
051131-07502	6" Dia. x 3/8"	5

Scotch-Brite™ Large Area Stripe Removal (LASR) Disc Assembly

- An 8" diameter, 16-layer version of the Scotch-Brite™ Molding Adhesive and Stripe Removal Disc (PNs 07501 and 07502).
- Designed to be used with a variable speed buffer with a 1500-3000 RPM speed range.
- The approved tool is the Black & Decker Buffmaster #6138.
- Not for use on lacquer coatings.



Part Number	Size	Quantity Per Case
051131-07517	8" Dia. x 5/8"	1

Scotch-Brite™ Large Area Stripe Removal (LASR) Adapter

Part Number

051131-07519*

*To order call VLR at 1-800-843-0619 or access website at www.cmprovh.com

3M™ Woodgrain and Stripe Remover

- For removing woodgrain vinyl and vinyl stripes from acrylic enamel surfaces.
- Jelly-like consistency keeps remover in place on vertical surfaces to promote fast-action when sprayed from the aerosol can.
- Saves on repair and repaint.
- For removal of adhesive residue follow-up with use of 3M™ Woodgrain and Stripe Adhesive Remover (PN08908).



Part Number	Container Size	Cans Per Case
051135-08907	24 oz. Aerosol	6

3M™ Woodgrain and Stripe Adhesive Remover

- Cleans off adhesive residue after woodgrain vinyl or vinyl stripes have been removed.
- Fast-acting remover can be used on all acrylic enamel painted metal surfaces.
- Jelly-like consistency keeps remover in place on vertical surfaces to promote fast-action when sprayed from an aerosol can.
- Saves on repair and repaint of the metal surface.



Part Number	Container Size	Cans Per Case
051135-08908	24 oz. Aerosol	6

3M™ Side Molding and Emblem Removal Tool

- Should be used with an air chisel to remove bonded moldings but can be used by hand to remove emblems/scripts.

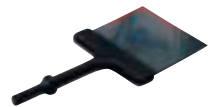

Part Number	Quantity Per Case
051135-08978	6

Scotchgard™ Paint Protection Film

Scotchgard™ Paint Protection Film

- A yellowing-resistant, clear protection film for reducing stone chipping and bug damage on painted surfaces.
- Excellent for hoods, valances, rocker areas, etc.
- For new cars and for refinished vehicles.
- **Non-returnable product.**



Part Number	Film Thickness	Roll Size
Rolls		
051141- 84701	14 mil*	1" x 12.5 yds.
051141- 84706	14 mil*	6" x 20 yds.
051141- 84802	8 mil*	2" x 40 yds.
051141- 84804	8 mil*	4" x 40 yds.
051141- 84806	8 mil*	6" x 40 yds.

Strips

051141- 84904	8 mil*	4" x 84"
051141- 84906	8 mil*	6" x 84"
051141- 84911	8 mil*	12" x 84"

* Total thickness including 2 mil adhesive.

Scotchgard™ Paint Protection Film Door Edge Guard

- 6 mil, clear coated urethane film with PSA.
- Used to protect door edges from potential nicks and abrasion.
- Use on new or recently refinished vehicles.



Part Number	Thickness	Roll Size
051141- 84901	6mm base (9mm with adhesive)	.4" x 10 yds.
051141- 84905	6mm base (9mm with adhesive)	.4" x 40 yds.

3M™ Scotchcal™ Striping Tapes Color Numbers

How To Order 3M™ Scotchcal™ Striping Tape:

1. Determine the 3-digit Pattern Number
2. Check color availability
3. Add 2-digit Color Number to Pattern Number

Example:

Pattern 723 in
color white (01)
is Part Number 72301

3M™ Scotchcal™ Color Numbers:

01 White	41 Azure Blue
02 Black	43 Silver Blue
03 Gold Metallic	50 Light Charcoal Metallic
04 Red	51 Dark Tundra
05 Silver Metallic	54 Medium Blue
06 Buckskin	56 Bright White
07 Brown	57 Light Blue Metallic
08 Blue	60 Camel Beige
09 Dark Blue	63 Charcoal Metallic
10 Burgundy	65 Dark Blue Metallic
12 Ultra Charcoal	66 Dark Red
14 Light Slate Metallic	67 Bright Yellow
16 Black Stardust	68 Bright Orange
17 Tan	69 Dark Green
18 Ocean Blue	70 Brown Metallic
19 Medium Gray	71 Teal
20 Silver Starfire	73 Gray
21 Nutmeg	74 Burgundy Metallic
22 Midnight Blue	76 Tomato Red
23 Silverchips	78 Pastel Sandstone
24 Dark Brown	79 Pale Gray
25 Gold Starfire	83 Medium Silver Metallic
28 Pewter	85 Light Gold Metallic
30 White Diamond	87 Bright Blue
31 Royal Blue	93 Low Gloss Black
33 Aquaessence	95 Mulberry
35 Aqua	96 Myan Green
37 Northern Blue	97 Medium Dark Gray
39 Deep Plum	99 Bright Gold Metallic

For color samples, please see the latest 3M™ Scotchcal™ Color Card (PN83005).

3M™ Scotchcal™ Striping Tapes Color Availability Grid

† When ordering, check color availability grid and insert last two digits to designate color number.

Colors 01-50

Roll Length	Pattern Number	01	02	03	04	05	06	07	08	09	10	12	14	16	17	18	19	20	21	22	23	24	25	28	30	31	33	35	37	39	41	43	50		
150'	687 †	•	•	•	•	•	•	•	•	•	•				•	•		•	•				•										•		
150'	696 †	•	•	•	•																													•	
40'	701 †	•	•	•	•	•	•	•	•	•	•					•	•							•										•	
40'	702 †	•	•	•	•	•	•	•	•	•	•	•	•				•							•					•	•				•	
40'	703 †	•	•	•	•	•	•	•	•	•	•		•		•	•								•										•	
40'	704 †	•	•	•	•	•	•	•	•	•	•													•										•	
40'	705 †	•	•	•	•	•	•	•	•	•	•													•										•	
50'	707 †	•	•	•	•	•	•	•	•	•	•													•										•	
50'	710 †	•	•	•	•	•	•	•	•	•	•													•										•	
50'	713 †	•	•	•	•	•	•	•	•	•	•		•		•	•	•	•	•	•	•	•	•		•	•	•	•			•			•	
150'	720 †	•	•	•	•	•	•	•	•	•	•	•	•		•	•	•	•	•	•	•	•	•	•	•	•	•	•	•	•	•	•	•	•	•
150'	721 †	•	•	•	•	•	•	•	•	•	•		•											•											•
150'	722 †	•	•	•	•	•	•	•	•	•	•	•	•		•	•	•	•	•	•	•	•	•	•	•	•	•	•	•	•	•	•	•	•	•
150'	723 †	•	•	•	•	•	•	•	•	•	•	•	•		•	•	•	•	•	•	•	•	•	•	•	•	•	•	•	•	•	•	•	•	•
150'	724 †	•	•	•	•	•	•	•	•	•	•	•	•		•	•	•	•	•	•	•	•	•	•	•	•	•	•	•	•	•	•	•	•	•
150'	725 †	•	•	•	•	•	•	•	•	•	•	•	•		•	•	•	•	•	•	•	•	•	•	•	•	•	•	•	•	•	•	•	•	•
150'	726 †	•	•	•	•	•	•	•	•	•	•	•	•		•	•	•	•	•	•	•	•	•	•	•	•	•	•	•	•	•	•	•	•	•
150'	727 †	•	•	•	•	•	•	•	•	•	•	•	•		•	•	•	•	•	•	•	•	•	•	•	•	•	•	•	•	•	•	•	•	•
150'	728 †	•	•	•	•	•	•	•	•	•	•	•	•		•	•	•	•	•	•	•	•	•	•	•	•	•	•	•	•	•	•	•	•	•
150'	729 †	•	•	•	•	•	•	•	•	•	•		•		•	•								•		•					•			•	
150'	730 †	•	•	•	•	•	•	•	•	•	•	•	•		•	•	•	•	•	•	•	•	•	•	•	•	•	•	•	•	•	•	•	•	•
150'	731 †	•	•	•	•	•	•	•	•	•	•													•											•
150'	732 †	•	•	•	•	•	•	•	•	•	•	•	•		•	•	•	•	•	•	•	•	•	•	•	•	•	•	•	•	•	•	•	•	•
150'	733 †	•	•	•	•	•	•	•	•	•	•													•											•
150'	734 †	•	•	•	•																														•
50'	736 †	•	•	•	•																														•
150'	761 †	•	•	•	•	•	•																												•
50'	762 †	•	•	•	•	•	•																												•
150'	763 †	•	•	•	•	•	•	•	•	•	•																								•
50'	764 †	•	•	•	•	•	•	•	•	•	•																								•
150'	769 †	•	•	•	•	•	•	•	•	•	•	•	•		•	•	•	•	•	•	•	•	•	•	•	•	•	•	•	•	•	•	•	•	•
150'	770 †	•	•	•	•	•	•	•	•	•	•	•	•		•	•	•	•	•	•	•	•	•	•	•	•	•	•	•	•	•	•	•	•	•
50'	771 †	•	•	•	•	•	•	•	•	•	•		•		•	•										•	•								•
30'	772 †	•	•	•	•	•	•	•	•	•	•	•	•		•	•	•	•	•	•	•	•	•	•	•	•	•	•	•	•	•	•	•	•	•
30'	773 †	•	•	•	•	•	•	•	•	•	•	•	•		•	•	•	•	•	•	•	•	•	•	•	•	•	•	•	•	•	•	•	•	•
50'	774 †	•	•	•	•	•	•	•	•	•	•															•	•								•
50'	775 †	•	•	•	•	•	•	•	•	•	•															•	•								•

• Available

3M™ Scotchcal™ Striping Tapes Color Availability Grid

† When ordering, check color availability grid and insert last two digits to designate color number.

Colors 51-99

Roll Length	Pattern Number	51	54	56 57	60	63	65	66 67 68 69 70	71	73 74	76	78 79	83	85	87	93	95	96 97	99
150'	687 †								•		••							•	
150'	696 †					•								•					
40'	701 †					•		•••			•					•			
40'	702 †			•		•		••••	•		•		•	•	•	•			
40'	703 †					•		•••			•		•	•	•	•			
40'	704 †					•					•			•					
40'	705 †					•					•								
50'	707 †					•								•					
50'	710 †					•								•					
50'	713 †		•	••	•	•	•	••	•	•	••	•	••	•	•			••	•
150'	720 †	•	•	••	•	•	•	•	••	•	••	•	••	•	•	•	•	••	•
150'	721 †					•	•	•			•		•	•				•	•
150'	722 †			•	•	•	•	•		••	•	•	•	•			•	•	
150'	723 †	•	•	••	•	•	•	•••••	•	••	•	••	•	•	•	•	•	••	•
150'	724 †	•		••	•	•	•	•	••		•	•	•	•			•		•
150'	725 †		•	•	•	•	•	•	•	•	•	•	•	•					•
150'	726 †		•	••	•	•	•	•••••	•	•	•	••	•	•	•		•	•	•
150'	727 †	•	•	••	•	•	•	•••••	•	••	•	••	•	•	•	•	•	••	•
150'	728 †	•			•	•	•	•••••		•	•			•	•	•		•	•
150'	729 †			••		•	•	•	•••	•	•		•	•	•			•	
150'	730 †	•	•	•	•	•	•	•••••	•	•	•	•	•	•	•	•	•	••	•
150'	731 †					•	•	•••••			•		•	•				••	•
150'	732 †	•		•	•	•		•			•	•		•					
150'	733 †			•		•	•				•		•	•					
150'	734 †					•					•			•					
50'	736 †																		
150'	761 †					•				•									
50'	762 †					•				•									
150'	763 †			•		•					•								
50'	764 †			•		•													
150'	769 †	•	•	••	•	•	•	•••••	•	••	•	••	•	•	•	•	•	••	•
150'	770 †	•	•	••	•	•	•	•••••	•	••	•	••	•	•	•	•	•	••	•
50'	771 †			•		•	•	•••••	•	•	•		•	•	•	•	•	•	•
30'	772 †	•	•	••	•	•	•	•••••	•	••	•	••	•	•	•	•	•	••	•
30'	773 †	•	•	••	•	•	•	••~	•	••	•	••	•	•	•	•	•	••	•
50'	774 †			•		•													
50'	775 †					•								•					

• Available

3M™ Scotchcal™ Striping Tapes

3M™ Scotchcal™ Custom Striping Tape



- For professional use in matching existing stripes or creating original striping designs.
- Fabricated from durable, colorfast 3M™ Scotchcal™ Film designed to resist chemicals and gasoline.
- Available in single, double and triple stripe rolls in a wide variety of colors.
- See 3M™ Scotchcal™ Striping Tape Color Availability Grid for color selection.

Part Number	Roll Size	Description (Stripe/Space/Stripe)
051141- 687 †	1/4" x 150'	1/16" - 1/8" - 1/16"
051141- 707 †	1/2" x 50'	1/8" - 1/8" - 1/4"
051141- 710 †	3/16" x 50'	1/16" - 1/16" - 1/16"
051141- 713 †	5/16" x 50'	1/16" - 1/8" - 1/8"
051141- 720 †	3/16" x 150'	1/16" - 1/16" - 1/16"
051141- 721 †	7/16" x 150'	1/16" - 3/16" - 3/16"
051141- 722 †	1/4" x 150'	1/16" - 3/32" - 3/32"
051141- 723 †	5/16" x 150'	1/16" - 1/8" - 1/8"
051141- 724 †	1/2" x 150'	1/8" - 1/8" - 1/4"
051141- 725 †	3/8" x 150'	1/16" - 1/8" - 3/16"
051141- 732 †	1/4" x 150'	1/16" - 1/16" - 1/8"

Part Number Linerless Single Stripe Rolls

Part Number	Size (stripe x roll)
051141- 701 †	1/16" x 40'
051141- 702 †	1/8" x 40'
051141- 703 †	1/4" x 40'
051141- 704 †	3/32" x 40'
051141- 705 †	3/16" x 40'

Single Stripe Rolls

051141- 726 †	1/4" x 150'
051141- 727 †	1/2" x 150'
051141- 728 †	3/4" x 150'
051141- 729 †	7/8" x 150'
051141- 730 †	1" x 150'
051141- 731 †	2" x 150'
051141- 733 †	3/8" x 150'
051141- 734 †	5/8" x 150'
051141- 736 †	3" x 50'
051141- 771 †	2" x 50'
051141- 774 †	4" x 50'
051141- 775 †	6" x 50'

3M™ Scotchcal™ Single Color Multiple Stripe — Pattern Number 696

- Six single color stripes in a 11/16" x 150' roll.

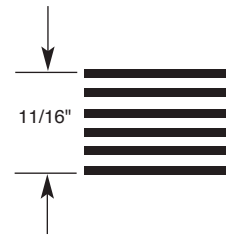

Part Number	Size	Description
051141- 696 †	11/16" x 150' Roll	Six 1/16" Stripes with Five 1/16" Voids

Available in Colors:

02 Black	41 Azure Blue
03 Gold Metallic	50 Light Charcoal Metallic
04 Red	63 Charcoal Metallic
05 Silver Metallic	85 Light Gold Metallic

3M™ Scotchcal™ Paint Break Stripes — Pattern Number 737

- Fits 1991 — 1994 Plymouth S Van and Dodge LE two-tone vehicles.

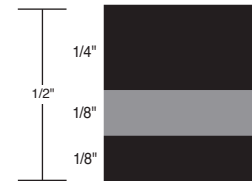

Part Number	Size	Description
051141- 737 †	1/2" x 150' Roll	1/4" Stripe 1/8" Stripe 1/8" Stripe

Available in Colors:

04 Black (02) Red (04) Black (02)	66 Black (02) Dark Red (66) Black (02)
50 Black (02) Light Charcoal Metallic (50) Black (02)	71 Black (02) Teal (71) Black (02)

† Insert last two digits when ordering to designate color number.

For color samples, please see the latest 3M™ Scotchcal™ Color Card (PN83005).

3M™ Scotchcal™ Striping Tapes

3M™ Scotchcal™ Paint Break Stripes — Pattern Number 738

• Fits 1991 and 1992 Ford Aerostar two-tone vehicles.

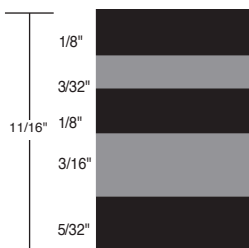

Part Number	Size	Description
051141-738 †	11/16" x 150' Roll	1/8" Stripe 3/32" Stripe 1/8" Stripe 3/16" Stripe 5/32" Stripe

Available in Colors:

- | | |
|---|---|
| <p>10 Burgundy (10)
Silver Metallic (05)
Burgundy (10)
Silver Metallic (05)
Burgundy (10)</p> <p>31 Royal Blue (31)
Silver Metallic (05)
Royal Blue (31)
Silver Metallic (05)
Royal Blue (31)</p> | <p>60 Camel Beige (60)
Nutmeg (21)
Camel Beige (60)
Nutmeg (21)
Camel Beige (60)</p> |
|---|---|

3M™ Scotchcal™ Tri-Tone Striping Tape — Pattern Number 741

• Allows the professional the opportunity of applying three colors in one application.

Part Number	Size	Description
051141-741 †	3/8" x 150' Roll	1/8" Stripe 1/8" Stripe 1/8" Stripe

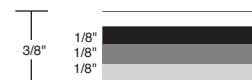

Available in Colors:

- | | |
|--|--|
| <p>01 Silver Metallic (05)
Charcoal Metallic (63)
Black (02)</p> <p>02 Camel Beige (60)
Buckskin (06)
Brown (07)</p> <p>08 Tomato Red (76)
Dark Red (66)
Burgundy Metallic (74)</p> | <p>09 Bright Blue (87)
Blue (08)
Dark Blue (09)</p> <p>10 Blue (08)
Light Blue Metallic (57)
Dark Blue (09)</p> <p>22 Light Gold Metallic (85)
Buckskin (06)
Gold Starfire (25)</p> |
|--|--|

3M™ Scotchcal™ Paint Break Stripes — Pattern Number 740

• Fits Ford Ranger and F-Series trucks.

Part Number	Size	Description
051141-740 †	7/8" x 150' Roll	7/32" Stripe 1/4" Stripe 13/32" Stripe

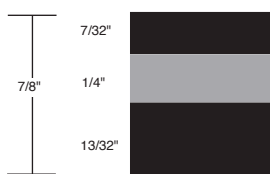

Available in Colors:

- | | |
|---|---|
| <p>02 Ocean Blue (18)
Black (02)
Ocean Blue (18)</p> <p>06 Buckskin (06)
Camel Beige (60)
Buckskin (06)</p> | <p>18 Ocean Blue (18)
Bright Blue (87)
Ocean Blue (18)</p> <p>40 Medium Silver Metallic (83)
Red (04)
Medium Silver Metallic (83)</p> |
|---|---|

† Insert last two digits when ordering to designate color number.

For color samples, please see the latest 3M™ Scotchcal™ Color Card (PN83005).

3M™ Scotchcal™ Striping Tapes

3M™ Scotchcal™ Duo-Tone Dual Color Double Stripe Tape — Pattern Number 746

• Helps the professional achieve the classic, rich look of two-color pinstriping in one easy application.

Part Number	Size	Description
051141- 746 †	5/16" x 150' Roll	1/16" Stripe 1/8" Void 1/8" Stripe



Available in Colors:

01 Silver Metallic (05) Burgundy Metallic (74)	25 Dark Red (66) Black (02)
02 Silver Metallic (05) Light Blue Metallic (57)	26 Bright White (56) Silver Metallic (05)
04 Bright Blue (87) Blue (08)	27 Silver Metallic (05) Silver Blue (43)
05 Dark Blue (09) Blue (08)	33 Light Charcoal Metallic (50) Black (02)
08 Camel Beige (60) Buckskin (06)	35 Silver Metallic (05) Light Charcoal Metallic (50)
15 Silver Metallic (05) Black (02)	50 Dark Red (66) Pewter (28)
17 Silver Metallic (05) Charcoal (63)	53 Silver Metallic (05) Burgundy (10)
18 Red (04) Black (02)	60 Silverchips (23) Ultra Charcoal (12)
24 Black (02) Light Gold Metallic (85)	

3M™ Scotchcal™ Styleline Two-Color Multiple Stripe Tape — Pattern Number 747

• A three-stripe configuration with two stripes being the same color and the third a complementary color.

Part Number	Size	Description
051141- 747 †	5/16" x 150' Roll	1/8" Stripe 3/64" Void 3/64" Stripe 3/64" Void 3/64" Stripe



Available in Colors:

50 Burgundy Metallic (74) Silver Metallic (05) Silver Metallic (05)	64 Charcoal Metallic (63) Pewter (28) Pewter (28)
51 Burgundy Metallic (74) Red (04) Red (04)	66 Black (02) Light Gold Metallic (85) Light Gold Metallic (85)
54 Charcoal Metallic (63) Silver Metallic (05) Silver Metallic (05)	76 Black Stardust (16) Gold Starfire (25) Gold Starfire (25)
56 Black (02) Silver Metallic (05) Silver Metallic (05)	80 Dark Red (66) Pewter (28) Pewter (28)
59 Dark Blue (09) Blue (08) Blue (08)	82 Silverchips (23) Ultra Charcoal (12) Ultra Charcoal (12)
61 Black (02) Red (04) Red (04)	

† Insert last two digits when ordering to designate color number.

For color samples, please see the latest 3M™ Scotchcal™ Color Card (PN83005).

3M™ Scotchcal™ Striping Tapes

3M™ Scotchcal™ Elite Two-Color Double Stripe Tape — Pattern Number 748

• A two-stripe, two-color configuration.

Part Number	Size	Description
051141- 748 †	3/16" x 150' Roll	1/16" Stripe 1/16" Void 1/16" Stripe



Available in colors:

01 Black (02) Gold Metallic (03)	14 Silver Metallic (05) Burgundy (10)
02 Silver Metallic (05) Black (02)	16 Silver Metallic (05) Burgundy Metallic (74)
03 White (01) Silver Metallic (05)	25 Charcoal Metallic (63) Light Slate Metallic (14)
04 Gold Metallic (03) Brown Metallic (70)	26 Brown (07) Buckskin (06)
06 Burgundy (10) Tomato Red (76)	28 Dark Blue (09) Royal Blue (31)
07 Silver Metallic (05) Tomato Red (76)	29 Black (02) Light Charcoal Metallic (50)
08 Light Gold Metallic (85) Burgundy Metallic (74)	30 Light Charcoal Metallic (50) Silver Metallic (05)
09 Blue (08) Dark Blue (09)	35 Silver Blue (43) Silver Metallic (05)
10 Silver Metallic (05) Charcoal Metallic (63)	65 Silverchips (23) Ultra Charcoal (12)
11 Gold Metallic (03) Silver Metallic (05)	

3M™ Application Tape

• For use as a backing, pre-mask or pre-spacing with 3M™ Scotchcal™ Signwriter 16" (772-†-____) and Signwriter 24" (773-†-____) Film rolls.

Part Number	Size and Description
051141- 75906	6" x 150' Roll
051141- 75951	15-1/2" x 150' Roll (Use with 3M™ Scotchcal™ Signwriter 16" (Patterns 769-†-____ and 772-†-____))
051141- 76051	23-1/2" x 150' Roll (Use with 3M™ Scotchcal™ Signwriter 24" (Pattern 770-†-____ or 773-†-____.))

3M™ Scotchcal™ Linescape 5 Striping Tape — Pattern Number 761

• A five-stripe, single-color configuration.

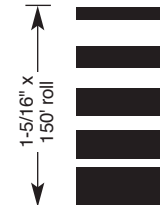

Part Number	Size	Description
051141- 761 †	1-5/16" x 150' RI.	1/16" T 3/8" V 3/32" T 5/32" V 5/32" T 3/32" V 7/32" T 1/16" V 9/32" T

Available in Colors:

01 White	05 Silver Metallic
02 Black	09 Dark Blue
03 Gold Metallic	63 Charcoal Metallic
04 Red	74 Burgundy Metallic

† Insert last two digits when ordering to designate color number.

For color samples, please see the latest 3M™ Scotchcal™ Color Card (PN83005).

3M™ Scotchcal™ Striping Tapes

3M™ Scotchcal™ Linescape 7 Striping Tape — Pattern Number 762

• A seven-stripe, single-color configuration.



Part Number	Size	Description
051141- 762 †	4-3/4" x 50' Roll	3/32" T 5/8" V 1/8" T 1/2" V 1/4" T 3/8" V 3/8" T 1/4" V 1/2" T 1/8" V 5/8" T 3/32" V 13/16" T

Available in Colors:

01 White	05 Silver Metallic
02 Black	09 Dark Blue
03 Gold Metallic	63 Charcoal Metallic
04 Red	74 Burgundy Metallic

3M™ Scotchcal™ Mini Dimension 5 — Pattern Number 763

• A five-stripe, single-color configuration.

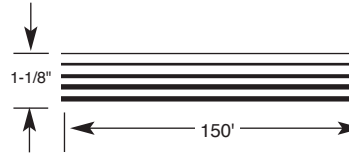

Part Number	Size	Description
051141- 763 †	1-1/8" x 150' Roll	1/16" T 3/16" V 3/32" T 5/32" V 1/8" T 3/32" V 5/32" T 1/16" V 3/16" T

Available in Colors:

02 Black	50 Light Charcoal Metallic
03 Gold Metallic	56 Bright White
05 Silver Metallic	63 Charcoal Metallic
09 Dark Blue	76 Tomato Red
10 Burgundy	

† Insert last two digits when ordering to designate color number.

For color samples, please see the latest 3M™ Scotchcal™ Color Card (PN83005).

3M™ Scotchcal™ Striping Tapes

3M™ Scotchcal™ Dimension 5 — Pattern Number 764

- A five-stripe, single-color configuration.

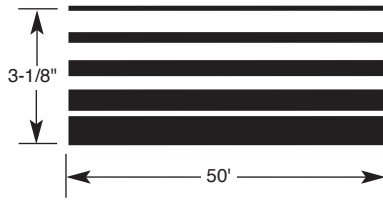

Part Number	Size	Description
051141- 764 †	3-1/8" x 50' Roll	1/8" T 1/2" V 1/4" T 3/8" V 3/8" T 1/4" V 1/2" T 1/8" V 5/8" T

Available in Colors:

02 Black	10 Burgundy
03 Gold Metallic	56 Bright White
04 Red	63 Charcoal Metallic
05 Silver Metallic	

3M™ Scotchcal™ Signwriter Film

- Designed to be used with computer aided graphic design equipment that uses friction feed rollers to move the film (not punched).
- May be also used as a 16" or 24" wide film sheet for special applications requiring wide film.
- Eliminates fitting together of smaller widths.
- Orders over 3 rolls may take an extended lead time.
- Available in all 3M™ Scotchcal™ colors.
- **Non-returnable product.**

Part Number	Size	Uses 3M™ Application Tape
051141- 769 †	16" x 150' Roll	PN75951
051141- 770 †	24" x 150' Roll	PN76051
051141- 772 †	16" x 30' Roll	PN75951
051141- 773 †	24" x 30' Roll	PN76051

† Insert last two digits when ordering to designate color number.

For color samples, please see the latest 3M™ Scotchcal™ Color Card (PN83005).

3M™ Scotchlite™ Reflective Striping

3M™ Scotchlite™ Reflective Striping Series 680 — Pattern Number 799

- Intended to provide bright, vivid daytime colors that also have light reflective qualities in darkness.
- Safety and nighttime visibility may be improved with 3M™ Scotchlite™ Reflective Striping.

Part Number	Color
1/4" x 50' Roll	
051141-79901	White (Silver)
051141-79902	Black
051141-79903	Gold
051141-79904	Red
051141-79905	Blue
051141-79906	Green
051141-79907	Orange
051141-79908	Yellow
1/2" x 50' Roll	
051141-79921	White (Silver)
051141-79922	Black
051141-79923	Gold
051141-79924	Red
051141-79925	Blue
051141-79926	Green
051141-79927	Orange
051141-79928	Yellow
3" x 50' Roll	
051141-79931	White (Silver)
051141-79932	Black
051141-79933	Gold
051141-79934	Red
051141-79935	Blue
051141-79936	Green
051141-79937	Orange
051141-79938	Yellow

3M™ Scotchlite™ Reflective Striping Series 680 — Pattern Number 799 (continued)

Part Number	Color
1" x 50' Roll	
051141-79941	White (Silver)
051141-79942	Black
051141-79943	Gold
051141-79944	Red
051141-79945	Blue
051141-79946	Green
051141-79947	Orange
051141-79948	Yellow
2" x 50' Roll	
051141-79961	White (Silver)
051141-79962	Black
051141-79963	Gold
051141-79964	Red
051141-79965	Blue
051141-79966	Green
051141-79967	Orange
051141-79968	Yellow
4" x 50' Roll	
051141-79971	White (Silver)
051141-79972	Black
051141-79973	Gold
051141-79974	Red
051141-79975	Blue
051141-79976	Green
051141-79977	Orange
051141-79978	Yellow
6" x 50' Roll	
051141-79981	White (Silver)
051141-79982	Black
051141-79983	Gold
051141-79984	Red
051141-79985	Blue
051141-79986	Green
051141-79987	Orange
051141-79988	Yellow

For color samples, please see the latest 3M™ Scotchlite™ Color Card (PN83005).

Accessories

3M™ Squeegees

- Designed to assist in the proper application of 3M™ Scotchcal™ Automotive Films.

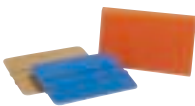

Part Number	Description	Quantity Per Set
051141-71601	Blue application squeegee	5
051141-71602	Gold application squeegee	5
051141-71607	Orange application squeegee recommended for paint protection film application.	1

3M™ Low Friction Sleeve

- Designed to assist in the proper application of 3M™ Scotchcal™ Automotive Films.
- Allows for smoother squeegee movement across film and vehicle surface.
- Fits over squeegees (PNs 71601 and 71602).



Part Number	Description	Quantity Per Set
051141-71603	Low friction sleeve (white), fits over blue and gold squeegees.	5

3M™ Air Release Tool

- Designed to assist in the proper application of 3M™ Automotive Graphics, Roll Goods and 3M™ Paint Protection Film.
- A “pen-like” tool to remove trapped air from under the surface of the graphic or paint protection film.



Part Number	Description	Quantity Per Set
051141-71604	Air release tool	5

3M™ Scotchcal™ Color Card

- 3M™ Scotchcal™ Color Card and Color/Pattern Availability Chart.
- Current 3M™ Scotchcal™ Color Card shipped automatically.



Part Number	Quantity Per Set
051141-83005	10

Retail Decorative, Protective, Reflective Products

3M™ Scotchlite™ Reflective Tape

- Safety/Identification tape for highest night time reflective brightness.

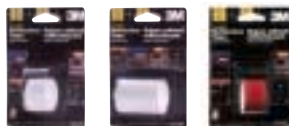

Part Number	Color	Size	Quantity Per Case
051131-03455	Silver	1" x 36"	24
051131-03456	Silver	2" x 36"	24
051131-03458	Red	1" x 36"	24
051131-03459	Red	2" x 36"	24

3M™ High Visibility Reflective Safety Strips

- Responds to the need for improved safety with 2" wide strips of an alternating red and white (silver) reflective tape.
- Constructed of 3M™ Diamond Grade™ Conspicuity Sheeting Series 981.
- Guaranteed to meet NHTSA's minimum spec's for seven (7) years.
- All material is edge sealed.



Part Number	Color	Size	Rolls Per Case
051131-03461	Alternating Red/White	2" x 18" (2 strips)	24
051131-03462	Alternating Red/White	2" x 18" (4 strips)	24
051131-03463	Alternating Red/White	2" x 12" (2-pack)	24
051131-03464	Alternating Red/White	2" x 12" (4-pack)	24

Index

By Part Number (continued)

Part Number	Page	Part Number	Page	Part Number	Page	Part Number	Page	Part Number	Page
051131-01319	31, 35	051144-01425	30, 32	051131-01620	30, 33	051131-01951	18, 20	051144-02134	36, 38
051131-01320	31, 35	051144-01426	30, 33	051131-01622	30, 33	051131-01952	18, 20	051144-02135	36, 38
051131-01321	31, 35	051144-01427	30, 33	051131-01623	30, 33	051131-01953	18, 20	051144-02136	36, 38
051131-01322	31, 34	051144-01428	30, 33	051131-01624	30, 33	051131-01987	36, 37	051144-02138	36, 38
051131-01323	31, 34	051131-01429	36, 37	051131-01625	30, 33	051131-01988	36, 37	051144-02139	36, 38
051131-01324	31, 34	051131-01430	36, 37	051131-01626	30, 33	051131-01989	25, 29	051144-02145	36, 38
051131-01325	31, 34	051131-01431	36, 37	051131-01628	30, 33	051131-01990	25, 29	051144-02172	36, 38
051131-01326	31, 34	051131-01432	31, 33	051131-01633	31, 33	051131-01991	25, 29	051144-02173	36, 38
051131-01327	31, 34	051131-01433	31, 33	051131-01634	31, 33	051144-02000	40, 41	051144-02174	36, 38
051131-01328	31, 34	051131-01434	31, 33	051131-01635	31, 33	051144-02001	40, 41	051144-02175	36, 38
051131-01329	31, 34	051144-01435	31, 33	051131-01636	31, 33	051144-02002	40, 41	051131-02220	24, 28
051131-01330	31, 34	051144-01436	31, 33	051131-01637	31, 33	051144-02003	40, 41	051144-02221	24, 28
051131-01331	31, 34	051144-01437	31, 33	051131-01638	31, 33	051144-02004	40, 41	051144-02222	24, 28
051131-01332	31, 34	051144-01438	31, 33	051131-01639	31, 33	051144-02005	40, 41	051131-02225	24, 28
051131-01333	31, 34	051144-01439	31, 33	051131-01640	31, 33	051144-02006	40, 41	051131-02226	24, 28
051131-01352	31, 34	051144-01440	31, 33	051131-01641	31, 33	051144-02007	40, 41	051131-02227	24, 28
051131-01353	31, 34	051144-01441	31, 33	051131-01642	31, 33	051144-02014	40, 41	051131-02230	24, 27
051131-01354	31, 34	051144-01442	31, 33	051131-01643	31, 33	051144-02015	40, 41	051144-02231	24, 27
051131-01355	31, 34	051144-01443	31, 33	051131-01660	24, 27	051144-02016	40, 41	051144-02232	24, 27
051131-01356	31, 34	051144-01465	36, 39	051131-01661	24, 27	051144-02017	40, 41	051144-02241	36, 38
051131-01357	31, 34	051144-01466	36, 39	051131-01665	24, 27	051144-02018	40, 41	051144-02248	36, 38
051131-01358	31, 34	051144-01467	36, 39	051131-01667	25, 27	051131-02019	40, 41	051131-02254	19, 21
051131-01359	31, 34	051144-01468	36, 39	051131-01668	25, 27	051131-02020	40, 41	051131-02256	19, 21
051131-01360	31, 34	051144-01469	36, 39	051131-01670	24, 27	051144-02021	40, 41, 76	051131-02258	19, 21
051131-01361	31, 34	051144-01470	36, 39	051144-01818	36, 37	051131-02022	40, 41, 76	051131-02259	19, 21
051131-01362	31, 34	051144-01471	36, 39	051144-01819	36, 37	051131-02023	40, 41, 76	051131-02260	24, 27
051131-01363	31, 34	051144-01472	36, 39	051144-01820	36, 37	051131-02032	40, 41	051131-02261	24, 27
051131-01372	31, 34	051144-01473	36, 39	051144-01833	36, 37	051131-02033	40, 41	051131-02262	24, 27
051131-01373	31, 34	051131-01484	30, 33	051144-01834	36, 37	051131-02034	40, 41	051131-02322	83
051131-01375	31, 34	051131-01485	30, 33	051144-01835	36, 37	051131-02035	40, 41	051144-02342	36, 39
051131-01376	31, 34	051131-01487	30, 33	051144-01867	36, 37	051131-02036	40, 41	051144-02344	36, 39
051131-01377	31, 34	051131-01488	30, 33	051144-01868	36, 37	051131-02037	40, 41	051144-02345	36, 39
051131-01378	31, 34	051131-01489	30, 33	051131-01913	24, 29	051131-02038	40, 41	051144-02346	36, 39
051131-01379	31, 34	051131-01490	30, 33	051131-01914	24, 29	051131-02039	40, 41	051144-02347	36, 39
051131-01380	31, 34	051131-01491	30, 33	051144-01915	24, 29	051131-02040	40, 41	051144-02348	36, 39
051131-01381	31, 34	051131-01492	30, 33	051131-01916	24, 29	051131-02041	40, 41	051144-02349	36, 39
051131-01382	31, 34	051131-01493	30, 33	051131-01921	24, 29	051131-02042	40, 41	051144-02350	36, 39
051131-01383	31, 34	051144-01501	25, 28	051131-01922	24, 29	051131-02043	40, 41	051144-02356	36, 39
051131-01396	24, 29	051144-01506	25, 28	051144-01923	24, 29	051131-02044	40, 41, 76	051144-02402	180
051131-01397	24, 29	051131-01545	24, 27	051131-01924	24, 29	051131-02045	40, 41, 76	051144-02404	180
051131-01398	24, 29	051131-01546	24, 27	051131-01927	24, 29	051131-02075	19, 23, 76, 82	051144-02406	180
051131-01406	24, 29	051131-01547	25, 27	051131-01928	24, 29	051131-02077	19, 23, 82	051144-02407	180
051131-01407	24, 29	051131-01548	25, 27	051144-01929	24, 29	051144-02086	40, 41	051144-02408	180
051131-01408	24, 29	051131-01549	25, 27	051131-01930	24, 29	051144-02103	36, 38	051144-02409	180
051131-01410	181	051131-01550	25, 27	051131-01932	36, 37	051144-02104	36, 38	051144-02410	180
051131-01411	181	051131-01551	25, 27	051131-01933	36, 37	051144-02112	36, 38	051144-02431	180
051131-01417	30, 32	051131-01561	25, 28	051131-01934	36, 37	051144-02113	36, 38	051144-02432	180
051131-01419	30, 32	051131-01566	25, 28	051131-01937	36, 37	051144-02114	36, 38	051144-02433	180
051144-01420	30, 32	051131-01569	24, 27	051131-01938	36, 37	051144-02115	36, 38	051131-02469	30, 32
051144-01421	30, 32	051131-01579	24, 27	051131-01939	36, 37	051144-02116	36, 38	051131-02470	30, 32
051144-01422	30, 32	051144-01613	36, 38	051131-01943	18, 20	051144-02117	36, 38	051131-02472	30, 32
051144-01423	30, 32	051144-01614	36, 38	051131-01944	18, 20	051144-02118	36, 38	051131-02473	30, 32
051144-01424	30, 32	051131-01619	30, 33	051131-01945	18, 20	051144-02119	36, 38	051131-02500	43, 56

Index

By Part Number (continued)

Part Number	Page	Part Number	Page	Part Number	Page	Part Number	Page	Part Number	Page
051131-02506	192	051131-02673	19, 22	051131-03410	110	051131-04179	148	051131-04924	151
051131-02507	185, 192	02700	83	051131-03420	110	051131-04186	149	051131-04926	151
051131-02510	192	051131-03001	65	051131-03441	110	051131-04188	149	051131-04927	151
051131-02512	192	051131-03002	65	051131-03442	110	04189	149	051131-04947	152
051131-02513	43, 56	051131-03003	65	051131-03451	100	054007-04218	109	051131-04991	152
051131-02514	192	051144-03004	65	051131-03455	231	051131-04223	149	051131-04997	152
051131-02515	192	051144-03005	65	051131-03456	231	051131-04225	149	051144-05001	179
051131-02519	174	051144-03007	65	051131-03458	231	051131-04226	149	051144-05002	179
051131-02530	143	051131-03008	65	051131-03459	231	051131-04227	149	051144-05003	179
051131-02536	31, 34	051131-03009	65	051131-03461	231	051131-04229	149	051144-05004	179
051131-02537	31, 34	051144-03010	65	051131-03462	231	051131-04240	149	051144-05005	179
051131-02538	31, 34	051144-03011	65	051131-03463	231	051131-04247	149	051144-05006	179
051131-02539	31, 34	051131-03012	65	051131-03464	231	051131-04274	149	051144-05007	179
051131-02540	31, 34	051144-03013	65	051131-03574	92	051144-04301	173	051144-05008	179
051131-02541	31, 34	051144-03015	65	051131-03601	164	051144-04303	173	051144-05009	179
051131-02542	31, 34	051131-03016	65	051131-03602	164	051144-04305	173	051144-05010	179
051131-02543	31, 34	051144-03017	65	051131-03607	164	051144-04308	173	051144-05021	179
051131-02544	31, 34	051131-03018	65	051131-03609	110	051144-04309	173	051144-05022	179
051131-02545	31, 34	051144-03019	65	051131-03614	110	051144-04310	173	051144-05024	179
051131-02546	31, 34	051131-03020	65	051131-03615	110	051144-04311	173	051144-05026	179
051131-02547	31, 34	051144-03021	65	051131-03616	110	051144-04313	173	051144-05027	179
051131-02548	31, 34	051131-03022	65	051131-03618	164	051144-04314	173	051144-05028	179
051131-02549	31, 34	051131-03024	65	051131-03738	200	051144-04319	173	051144-05029	179
051131-02551	30, 34	051131-03025	66	054007-03744	110	051131-04320	150	051144-05030	179
051131-02552	30, 34	051131-03026	66	054007-03754	200	051144-04329	173	051144-05042	179
051131-02553	30, 34	051144-03031	65	054007-03768	200	051131-04330	150	051144-05044	179
051131-02554	30, 34	051144-03035	65	054007-03774	200	051144-04333	173	051144-05046	179
051131-02567	30, 34	051144-03038	65	054007-03784	200	051144-04334	173	051144-05047	179
051131-02568	30, 34	051131-03039	66	054007-03785	200	051144-04335	173	051144-05048	179
051131-02569	30, 34	051131-03050	208	051131-03801	200	051144-04337	173	051144-05049	179
051131-02589	30, 33	051131-03051	208	051131-03804	200	051144-04338	173	051144-05050	179
051131-02590	30, 33	051131-03055	208	051131-03858	200	051131-04350	150	051144-05071	179
051131-02591	30, 33	051131-03057	208	051131-03874	200	051144-04351	173	051144-05072	179
051131-02593	30, 33	051144-03110	66	051131-03884	200	051144-04353	173	051144-05073	179
051131-02594	30, 33	051144-03111	66	051131-03983	200	051131-04374	150	051131-05100	179
051131-02595	30, 33	051144-03112	66	051131-03984	200	051131-04423	180	051131-05101	179
051131-02596	30, 33	051131-03114	66	051131-03985	200	051144-04501	180	051131-05102	179
051131-02597	30, 33	051131-03115	66	051131-04030	147	051144-04516	180	051131-05103	179
051131-02598	30, 33	051131-03116	66	051131-04031	147	051144-04541	180	051131-05104	179
051131-02599	30, 33	03130	66	051131-04036	147	051144-04561	180	051131-05105	179
051131-02600	36, 39	03131	66	051131-04040	147	051131-04747	150	051131-05106	179
051131-02601	36, 39	051144-03132	66	051131-04041	147	051131-04806	150	051131-05107	179
051131-02602	36, 39	051144-03140	66	051131-04045	147	051131-04847	150	051131-05108	179
051131-02604	36, 39	051144-03142	66	051131-04050	147	051131-04901	150	051131-05109	179
051131-02606	36, 39	051144-03148	66	051131-04052	147	051131-04902	151	051131-05110	179
051131-02621	40, 41	051131-03171	208	051131-04058	148	051131-04903	151	051131-05111	179
051131-02622	40, 41	051131-03172	208	051131-04125	148	051131-04904	151	051131-05112	179
051131-02623	40, 41	051144-03192	92	021200-04134	102	051131-04907	151	051131-05113	179
051131-02624	40, 41	051131-03193	66	051131-04147	148	051131-04908	151	051131-05240	42, 50
051131-02625	40, 41	051111-03201	140	051131-04150	148	051131-04909	151	051131-05241	42, 50
051131-02669	19, 22	021200-03320	100	051131-04154	148	051131-04910	151	051131-05242	42, 50
051131-02670	19, 22	051131-03405	110	051131-04176	148	051131-04912	151	051131-05244	42, 50
051131-02672	19, 22	051131-03408	100	051131-04178	148	051131-04914	150	051131-05248	42, 51

Index

By Part Number (continued)

Part Number	Page	Part Number	Page	Part Number	Page	Part Number	Page	Part Number	Page
051131-05250	42, 51	051144-05577	43, 55	051131-05773	42, 49	051131-05910	162	051131-06063	75, 77, 78
051131-05251	42, 44, 48, 76, 77	051144-05578	43, 55	051131-05774	42, 44, 49	051131-05911	162	051131-06064	75, 77, 82
051131-05268	42, 47	051144-05579	42, 45	051131-05775	42, 47	051131-05912	152	051131-06065	75, 77, 82
051131-05269	42, 47	051131-05581	42, 45	051131-05776	42, 44, 47	051131-05913	152	051131-06066	75, 77, 85
051131-05270	42, 48	051131-05582	42, 45	051131-05779	42, 47	051131-05916	152	051131-06067	75, 77, 85
051131-05271	42, 49	051144-05585	42, 46	051131-05781	42, 49	051131-05919	152	051131-06070	75, 77, 82
051131-05273	42, 49	051144-05586	42, 46	051131-05782	42, 49	051131-05921	40, 41	051131-06071	75, 77, 82
051131-05274	42, 44, 49, 76	051131-05591	42, 46	051131-05783	42, 49	051131-05924	84	054007-06100	109
051131-05275	42, 48	051131-05632	43, 54	051131-05791	42, 49	051131-05925	84	054007-06101	109
051131-05276	42, 44, 48	051144-05633	43, 54	051131-05792	42, 49	051131-05928	81	054007-06106	194
051131-05279	42, 48	051144-05634	43, 54	051131-05800	211	051131-05929	81	054007-06107	194
051131-05280	42, 48	051131-05637	43, 54	051131-05801	211	051131-05930	81	054007-06119	195
051131-05281	42, 48	051131-05646	43, 53	051131-05804	211	051131-05931	81	054007-06120	195
051131-05282	42, 48	051131-05655	43, 53	051131-05805	211	051131-05933	78	054007-06122	195
051131-05283	42, 48	051131-05656	43, 53	051131-05808	211	051131-05934	78	054007-06123	195
051131-05286	42, 44, 48	051131-05681	43, 53	051131-05810	211	051131-05936	78	054007-06126	195, 196
051131-05291	42, 49	051144-05700	77, 79	051131-05814	211	051131-05937	81	054007-06127	195
051131-05292	42, 49	051144-05701	77, 79	051131-05815	211	051131-05938	81	054007-06128	195
051131-05348	42, 52	051131-05703	77, 79	051131-05816	211	051131-05940	78	054007-06129	195
051131-05351	42, 52	051131-05704	77, 79	051131-05819	212	051131-05941	81, 85	054007-06130	108
051131-05355	42, 52	051144-05705	77, 83	051131-05821	212	051131-05943	81, 85	054007-06132	108
051131-05356	42, 52, 76, 77	051144-05710	77, 81	051131-05824	212	051131-05954	78	054007-06133	108
051131-05357	42, 52	051131-05711	77, 79	051131-05825	211	051144-05955	78	054007-06138	109
051131-05380	42, 52	051131-05713	77, 83	051131-05826	211	051144-05960	87, 213	054007-06141	195
051131-05381	42, 52	051131-05717	81, 84	051131-05830	213	051144-05964	87, 213	054007-06142	195
051131-05382	42, 52	051131-05718	77, 81, 84	051131-05833	213	051144-05966	87, 213	054007-06143	108
051144-05440	42, 46	051131-05719	77, 79	051131-05834	213	051144-05972	87, 213	054007-06144	195
051144-05441	42, 46	051144-05720	92	051131-05835	211	051131-05973	78	054007-06145	195
051144-05442	42, 46	051131-05721	80	051131-05836	213	051131-05974	78	054007-06149	109
051144-05444	42, 46	051131-05722	83	051131-05837	214	051131-05975	124	054007-06150	195
051144-05446	42, 51	051131-05723	77, 80	051131-05838	214	051131-05983	78	054007-06151	195
051144-05448	42, 46	051131-05725	77, 83	051131-05839	211	051131-05990	85	054007-06152	196
051144-05450	42, 56	051131-05726	77, 83	051131-05840	211	051131-05991	82	054007-06160	196
051131-05451	42, 56	051131-05729	77, 83	051131-05841	211	051131-05992	82	054007-06161	196
051144-05452	42, 56	051131-05731	77, 80	051131-05842	214	051131-05995	82	054007-06165	109
051144-05517	43, 56	051131-05733	77, 80	051131-05843	214	051131-05996	82	054007-06171	198
051144-05518	43, 56	051131-05735	77, 83	051131-05844	214	051131-06000	85	054007-06172	198
051144-05519	43, 55	051131-05737	77, 80	051131-05848	42, 53	051131-06001	82	054007-06192	106
051131-05520	43, 55	051131-05738	77, 84	051131-05854	214	051131-06005	86	054007-06195	106
051131-05526	43, 55	051131-05739	77, 84	051131-05855	42, 52	051131-06006	86	054007-06196	106
051144-05530	42, 55	051131-05740	42, 50	051131-05856	42, 52	051131-06010	86	054007-06200	193
051131-05533	43, 54	051131-05741	42, 50	051131-05860	214	051131-06011	78	054007-06201	193
051131-05538	43, 54, 205	051131-05742	42, 50	051131-05861	214	051131-06013	204	054007-06202	193
051144-05539	43, 54, 205	051131-05744	42, 50	051131-05868	212	051131-06016	77, 86	054007-06203	193
051144-05540	43, 54, 205	051131-05746	42, 51	051131-05870	212	051131-06017	77, 86	054007-06204	193
051131-05541	43, 54, 205	051131-05748	42, 51	051131-05871	212	051131-06018	77, 86	054007-06205	193
051131-05546	42, 44, 45	051131-05750	42, 51	051131-05881	42, 53	051131-06021	78	054007-06207	193
051131-05555	42, 45	051131-05755	42, 47	051131-05883	153	051131-06031	78	054007-06220	194
051131-05556	42, 44, 45	051131-05756	42, 44, 47	051131-05885	146	051131-06032	78	054007-06224	193
051131-05568	42, 45	051131-05766	213	051131-05887	146	051131-06059	85	054007-06225	193
051144-05575	42, 45	051131-05768	42, 47	051131-05895	153	051131-06060	75, 77, 78	054007-06226	193
051144-05576	42, 44, 45	051131-05769	42, 47	051131-05896	153	051131-06061	75, 77, 78	054007-06227	193
		051131-05771	42, 49	051131-05907	153	051131-06062	75, 77, 78	054007-06228	193

Index

By Part Number (continued)

Part Number	Page	Part Number	Page	Part Number	Page	Part Number	Page	Part Number	Page
054007-06232	193	021200-06378	98	021200-06515	113	051131-06794	115	021200-06944	104
054007-06234	193	021200-06380	98	021200-06518	113	051131-06795	115	021200-06947	102
054007-06240	193	021200-06381	98	021200-06524	113	051131-06796	115	051131-06950	106
054007-06243	193	051131-06382	99	021200-06530	113	051131-06798	115	051131-06951	106
054007-06248	193	051131-06383	99	051131-06532	97	051131-06802	115	021200-06953	104
054007-06249	193	051131-06384	99	051131-06534	97	051131-06804	115	051131-06954	102
054007-06250	193	051131-06385	99	051131-06535	97	021200-06810	114	021200-06955	105
054007-06251	193	051131-06386	99	021200-06536	113	021200-06814	114	051131-06964	105
054007-06252	193	051131-06386	99	051131-06537	113	051115-06817	97	051131-06965	105
054007-06256	193	051131-06396	99	051131-06538	113	051115-06818	97	051131-06969	100
054007-06258	193	051131-06397	99	051131-06539	113	051115-06819	97	021200-06970	101
054007-06264	193	051131-06398	217	051131-06540	113	051115-06820	97	021200-06971	101
054007-06267	193	051131-06399	217	051131-06541	97	051131-06821	106	051131-06975	101
054007-06270	193	051131-06404	98	021200-06405	98	051131-06837	69	051131-06976	101
054007-06271	193	021200-06405	98	051131-06408	98	051131-06839	69	06980	101
054007-06272	193	051131-06408	98	051131-06409	98	051131-06840	69	051131-06984	101
054007-06273	193	051131-06409	98	021200-06415	106	051131-06845	116	051131-06993	105
054007-06274	193	021200-06415	106	021200-06420	106	051131-06846	116	051131-06994	105
054007-06275	193	021200-06420	106	021200-06421	106	051131-06847	116	051131-06996	105
054007-06277	193	021200-06421	106	021200-06423	106	051131-06848	116	051131-06997	105
051131-06296	96	021200-06423	106	021200-06424	106	051131-06849	116	051131-07000	120
051131-06297	96	021200-06424	106	021200-06425	106	051131-06851	116	051131-07001	120, 126
051131-06298	96	021200-06425	106	021200-06450	100	051131-06854	116	051131-07002	120, 126
021200-06300	98	021200-06450	100	021200-06451	100	051131-06855	116	051131-07003	120, 126
021200-06301	98	021200-06451	100	021200-06452	100	051131-06856	116	051131-07006	128
021200-06302	98	021200-06452	100	021200-06453	100	051131-06857	116	051131-07007	128
021200-06303	98	021200-06453	100	021200-06454	100	051131-06860	116	051131-07008	128
021200-06305	98	021200-06454	100	021200-06455	100	021200-06864	114	051131-07009	128
021200-06306	98	021200-06455	100	021200-06456	100	021200-06865	115	051131-07010	128, 129, 131
021200-06307	98	021200-06456	100	021200-06457	100	021200-06866	115	051131-07011	128, 129, 131
021200-06308	98	021200-06457	100	021200-06458	100	021200-06869	115	051131-07012	128, 129, 131
021200-06312	98	021200-06458	100	051131-06462	107	021200-06871	115	051131-07024	120, 121, 131
021200-06314	98	051131-06462	107	051131-06463	107	021200-06875	106	051131-07025	120, 121, 131
021200-06330	96	051131-06463	107	051131-06464	107	021200-06888	102	051131-07026	120, 121, 131
021200-06332	96	051131-06464	107	051131-06465	107	051131-06893	101	051131-07027	119, 125
021200-06334	96	051131-06465	107	021200-06466	106	051131-06894	101	051131-07028	129
021200-06335	96	021200-06466	106	021200-06467	106	051131-06895	101	051131-07029	129
021200-06336	96	021200-06467	106	021200-06468	106	051131-06896	101	051131-07030	129
021200-06338	96	021200-06468	106	021200-06469	106	051131-06897	101	051131-07031	129
021200-06340	96	021200-06469	106	021200-06470	106	051131-06898	101	051131-07032	129
021200-06341	96	021200-06470	106	051131-06480	107	021200-06908	104	051131-07033	128, 129, 131
051131-06342	97	051131-06480	107	051131-06481	107	021200-06909	104	051131-07034	128, 129, 131
021200-06343	96	051131-06481	107	051131-06483	107	021200-06910	104	051131-07035	128, 129, 131
021200-06344	96	051131-06483	107	051131-06484	107	021200-06923	104	051131-07036	129
051131-06345	97	051131-06484	107	051131-06488	107	021200-06924	104	051131-07037	129
021200-06346	96	051131-06488	107	051131-06491	108	021200-06925	104	051131-07038	129
051131-06347	97	051131-06491	108	051131-06492	108	021200-06927	108	051131-07039	129
051131-06348	97	051131-06492	108	051131-06493	108	021200-06930	106	051131-07042	129
051131-06349	97	051131-06493	108	021200-06503	113	051131-06937	101	051131-07043	129
051131-06356	106	021200-06503	113	021200-06506	113	051131-06938	101	051131-07044	129
051131-06370	100	021200-06506	113	051131-06508	113	051131-06939	101	051131-07045	129
051131-06375	100	051131-06508	113	021200-06509	113	021200-06941	106	051131-07046	121, 122
021200-06377	98	021200-06509	113	021200-06512	113	021200-06943	106	051131-07047	122
		051131-06788	116						

Index

By Part Number (continued)

Part Number	Page	Part Number	Page	Part Number	Page	Part Number	Page	Part Number	Page
051131-07048119, 125	051131-07187119, 125	051131-07504206	051135-08090155	051135-08531159
051131-07054	..120, 121, 122	051131-07189119, 125	051131-07505206	051135-08101155, 182	051131-08533171
051131-07063124	051131-07190127	051131-07506206	051135-08107143	051131-08534171
051131-07065123	051131-07191120, 126	051131-07507206	051135-08115143	051135-08551159, 182
051131-07130130	051131-07192120, 126	051131-07508206	051135-08116143	051135-08552188, 191
051131-07131130	051131-07193120, 126	051131-07509206	051135-08117175	051135-08564171
051131-07132130	051131-07194	..120, 121, 122	051131-07511206	051135-08155155, 182	051135-08566172
051131-07133130	051131-07195	..121, 122, 123	051131-07512206	051135-08180181	051135-08578159
051131-07134130	051131-07196127	051131-07513206	051135-08191175	051135-08606174
051131-07135130	053200-0722092	051131-07514206	051131-08193175	051135-08609172
051131-07136130	053200-0733092	051131-07515206	051135-08215143	051135-08610173
051131-07137130	051131-07410203	051131-07516206	051135-08217143	051135-08611173
051131-07138122, 131	051131-07439203	051131-07517219	051135-08219143	051135-08612173
051131-07139122, 131	051131-07441203	051131-07519219	051135-08223143	051135-08620173
051131-07140122, 131	051131-07442203	051131-07521204	051135-08224144	051135-08621173
051131-07141122, 131	051131-07443203	051131-07522204	051135-08227144	051135-08622173
051131-07142122, 131	051131-07444203	051131-07523203	051135-08229144	051135-08625173
051131-07143122, 131	051131-07445203	051131-07524206	051135-08235144	051135-08633174
051131-07144122, 131	051131-07447203	051131-07525206	051135-08237144	051135-08634174
051131-07145122, 131	051131-07448203	051131-07526206	051131-08239144	051135-08641174
051131-07147131	053200-0744992	051131-07527206	051135-08243144	079996-08650100
051131-07148131	051131-07450206	051131-07528206	051135-08267144	079996-08651100
051131-07149131	051131-07451206	051131-07529206	051135-08268145	051135-08656159
051131-07150131	051131-07453206	051131-07530206	051135-08269145	051135-08661159, 183
051131-07152131	051131-07455206	051131-07531206	051135-08270145	051135-08662159, 183
051131-07153131	051131-07456206	051131-07532206	051135-08271144	051135-08663159, 183
051131-07154131	051131-07457206	051131-07542207	051135-08272145	051135-08664159, 183
051131-07155131	051131-07460204	051131-07543207	051135-08273145	051135-08667172
051131-07156131	051131-07461204	051131-07544207	051135-08274145	051135-08672159, 182
051131-07157131	051131-07466204	051131-07705207	051135-08275145	051135-08681171
051131-07158131	051131-07467205	051131-07744180, 205	051135-08277145	051135-08688171
051131-07160123	051131-07468205	051131-07745204	051135-08280146	051135-08689172
051131-07161122, 126	051131-07469205	051131-07747204	051135-08300158	051135-08690172
051131-07162122, 126	051131-07470205	051131-07748204	051135-08301158	051135-08691171
051131-07163122, 126	051131-07471205	051131-07777205	051135-08302158	051135-08692171
051131-07164132	051131-07472205	051131-0790979	051135-08307146	051135-08693172
051131-07165132	051131-07474207	051131-0791079	08308146	051135-08695172
051131-07166132	051131-07475207	051131-07950140	08360158	051135-08696172
051131-07167132	051131-07480206	051131-07951140	08361158	051135-08698172
051131-07168132	051131-07481206	051131-07952140	051135-08369158	051135-08700183
051131-07169132	051131-07482206	051135-08001153, 182	051135-08370158	051135-08704183
051131-07172132	051131-07483206	051135-08002153, 182	051135-08374158	051135-08730183
051131-07173132	051131-07485206	051135-08008153, 182	051135-08398175	051135-08731183
051131-07175132	051131-07486206	051135-08011153, 182	051135-08399175	051135-08752183
051131-07177121, 126	048011-07491205	051135-08031153	051135-08400175	051135-08796183
051131-07178121, 126	048011-07492206	051135-08046154	051135-08405158	051135-08801176
051131-07179121, 126	051131-07493206	051135-08051154	051135-08458146	051135-08804162
051131-07181120, 126	048011-07494206	051135-08054154	051131-08463146	051135-08812190
051131-07182120, 126	051131-07498219	051135-08061154, 182	051135-08475158	08813190
051131-07183120, 126	051131-07499219	051135-08063154	051135-08476158	051131-08816189
051131-07184120	051131-07500219	051135-08069154	051135-08500158	051131-08817188, 189
051131-07185119, 125	051131-07501219	051131-08074154	051135-08505158	051135-08820188, 191
051131-07186119, 125	051131-07502219	051135-08088154, 182	051135-08509159, 174	051135-08821188, 191

Index

By Part Number (continued)

Part Number	Page	Part Number	Page	Part Number	Page	Part Number	Page	Part Number	Page
051135-08822	188, 191	051135-08917	188, 189, 191	054007-09426	197	051131-16046	10	051131-16220	13
051135-08823	188, 191	051135-08919	188, 189, 191	054007-09427	197	051131-16053	10	051131-16221	13
051135-08824	188, 191	051135-08920	188, 189, 191	054007-09428	197	051131-16054	10	051131-16222	13
051135-08825	188, 191	051135-08921	189, 191	054007-09429	197	051131-16055	12	051131-16223	14
051135-08826	191	051135-08922	189, 191	054007-09430	197	051131-16056	12	051131-16224	14
051135-08827	191	051135-08923	189, 191	054007-09431	197	051131-16057	12	051131-16226	13
051135-08828	188, 191	051135-08927	189, 191	054007-09458	197	051131-16058	12	051131-16227	13
051135-08829	188	051135-08931	191	051131-09930	175	051131-16059	12	051131-16228	13
051135-08830	188	051135-08932	189	054007-11820	196	051131-16060	12	051131-16229	13
051135-08831	188, 191	051135-08937	189, 191	054007-11822	196	051131-16061	12	051131-16230	14
051135-08833	188, 191	051135-08941	189, 191	054007-11900	196	051131-16062	12	051131-16231	14
051135-08834	188, 191	051135-08944	189, 191	054007-11913	196	051131-16064	12	051131-16232	13
051135-08836	188, 191	051135-08945	181	054007-11914	196	051131-16065	12	051131-16233	13
051135-08837	188, 191	051135-08946	185	054007-11915	196	051131-16066	12	051131-16234	14
051135-08838	188, 191	051135-08949	163	054007-11918	196	051131-16081	12	051131-16235	13
051135-08843	188, 191	051135-08955	190	054007-11919	196	051131-16082	12	051131-16236	13
051135-08844	188, 191	051135-08956	190	054007-11920	196	051131-16083	12	051131-16237	13
051135-08845	188, 191	051135-08958	185	054007-11921	196	051131-16084	12	051131-16238	13
051135-08846	191	051135-08960	185	054007-11922	196	051131-16085	12	051135-16242	217
051135-08849	191	08960-A	191	054007-11923	196	051131-16086	12	051135-16243	217
051135-08853	191	08960-ADP	191	054007-11924	196	051131-16087	12	051135-16244	217
051135-08854	189, 191	08960-Y	191	054007-11926	196	051131-16088	12	051135-16281	217
051135-08855	191	051135-08962	185	054007-11927	196	051131-16090	12	051135-16282	217
051135-08856	191	051135-08964	163	054007-11928	196	051131-16091	12	17020	124
051135-08857	189, 191	051135-08966	163	054007-11932	196	051131-16099	12	17021	124
051135-08858	189, 191	051135-08978	219	054007-11934	196	051131-16102	10	021200-18813	103
051135-08859	191	051135-08983	87, 185	054007-11935	196	051131-16103	10	021200-19008	105
051135-08860	189, 191	051135-08984	155	054007-11939	196	051131-16104	10	048011-19221	138
051135-08861	191	051135-08986	155	054007-11960	196	051131-16105	10	048011-19280	138
051135-08862	191	051135-08987	155	054007-12174	197	051131-16106	11	048011-19288	138
051135-08863	189, 191	051135-08991	175	051144-13441	84	051131-16109	11	048011-19289	138
051135-08864	162	051135-08992	176	054007-13760	196	051131-16110	11	048011-19290	138
051131-08866	183	051135-08993	176	021200-14765	103	051131-16111	10	048011-19303	138
051135-08871	189, 191	051135-08994	176	021200-14766	103	051131-16113	7	048011-19304	138
051135-08872	189, 191	051135-08997	176	048011-15012	207	051131-16114	7	048011-19305	138
051135-08874	162	051135-08998	163	054007-15769	195	051131-16115	7	048011-19315	138
051135-08875	184	054007-09230	195	021200-15872	103	051131-16116	11	048011-19316	138
051135-08877	184	054007-09231	195	051131-16000	7	051131-16204	13	048011-19317	138
051135-08878	184	054007-09368	197	051131-16001	7	051131-16205	13	048011-19318	138
051135-08880	181	054007-09369	197	051131-16003	8	051131-16206	13	048011-19319	138
051135-08881	162	054007-09370	197	051131-16005	8	051131-16207	13	048011-19320	138
051131-08883	162	054007-09371	197	051131-16006	8	051131-16208	13	048011-19321	138
051135-08888	174, 184	054007-09372	197	051131-16007	9	051131-16209	13	048011-19322	138
051135-08891	163	054007-09373	197	051131-16008	9	051131-16210	13	048011-19323	138
051135-08892	163	054007-09374	197	051131-16010	12	051131-16211	13	048011-19324	138
051135-08895	181	054007-09375	197	051131-16015	9	051131-16212	13	048011-19325	138
051135-08897	184	054007-09376	197	051131-16016	9	051131-16213	13	048011-19339	139
051135-08898	184	054007-09377	197	051131-16017	9	051131-16214	13	048011-19340	139
051135-08899	185	054007-09378	197	051131-16018	9	051131-16215	13	048011-19341	139
051131-08901	185	054007-09404	197	051131-16019	12	051131-16216	13	021200-21183	155
051135-08907	219	054007-09423	197	051131-16022	9	051131-16217	13	021200-21210	155
051135-08908	219	054007-09424	197	051131-16023	7	051131-16218	13	021200-21791	175
051135-08911	190	054007-09425	197	051131-16024	7	051131-16219	13	051138-22058	218

Index

By Part Number (continued)

Part Number	Page	Part Number	Page	Part Number	Page	Part Number	Page	Part Number	Page
051138-22059218	051131-3152261	051135-36618198	051131-37106134	051131-3807689
051138-22060218	051131-3154761	051135-36619198	051131-37107134	051131-3807789
054007-22880196	051131-3154861	051135-36620198	051131-37108133	051131-3807889
054007-22997196	051131-3154961	051135-36621198	051131-37109133	051131-3807989
048011-23322137	051131-3155061	051135-36622198	051131-37113134	051131-3808089
048011-23748137	051131-3155161	051135-36623198	051131-37114134	051131-3808189
048011-23749137	051131-3191462	051131-37001131	051131-37115134	051131-3808289
048011-23750137	051131-3191562	051131-37002131	051131-37116134	051131-3808690
048011-23764137	051131-3192262	051131-37003122	051131-37119134	051131-3808790
048011-23766137	051131-3192362	051131-37004122	051131-37120135	051131-3809590
048011-23767137	051131-3199062	051131-37005122	051131-37121135	051131-3809990
048011-23768137	051131-3201562	051131-37006122	051131-37122136	051131-3810090
048011-23769137	051131-3202162	051131-37007122	051131-37123136	051131-3810190
048011-23788137	051131-3202262	051131-37008128	051131-37124	..134, 135, 136	051131-3810591
048011-23789137	051131-3202362	051131-37009128	051131-37125	..134, 135, 136	3811185, 90
048011-23790137	051131-3203562	051131-37010128	051131-37126	..134, 135, 136	051131-3811391
048011-23791137	051131-3203662	051131-37011128	051131-37127	..134, 135, 136	051131-3811491
048011-23793137	051131-3203762	051131-37012128	051131-37129134	051131-3811691
051131-2633096	051131-3203862	051131-37013128	051131-37130	..134, 135, 136	051131-3812489
051131-2633296	051131-3203962	051131-37014128	051131-37131	..134, 135, 136	051131-3812589
051131-2633496	051131-3204062	051131-37015128	051131-37132	..134, 135, 136	051131-3812689
051131-2633596	051131-3204262	051131-37016128	051131-37133	..134, 135, 136	051131-3812789
051131-2633696	051131-3204362	051131-37017128	051131-37134	..134, 135, 136	051131-3812889
051131-2633896	051131-3204462	051131-37018128	051131-37135	..134, 135, 136	051131-3812989
051131-2634096	051131-3211562	051131-37019128	051131-37136	..134, 135, 136	3813385, 91
051131-2634196	051131-3211862	051131-37020128	051131-37137	..134, 135, 136	051131-3822190
051131-2634396	051131-3222062	051131-37021119, 125	051131-37138	..134, 135, 136	051131-3822290
051131-2634496	051131-3222162	051131-37022119, 125	051131-37139	..134, 135, 136	051131-3830088
048011-26417138	051131-3222262	051131-37023123	051131-37140	..134, 135, 136	051131-3832788, 90
048011-26418138	051131-3223063	051131-37027128	051131-37141	..134, 135, 136	051131-3832888, 90
048011-26419138	051131-3223163	051131-37030130	051131-37142134, 136	051131-3835088
048011-26420138	051131-3223263	051131-37031130	051131-37143134, 136	051131-3835188
048011-26421138	051131-3254163	051131-37032130	051131-37144134, 136	051131-3837488
048011-26422138	051131-3254463	051131-37033130	051131-37145134, 136	051131-3837588
051135-31015217	051131-3254563	051131-37034131	051131-37146134, 136	051131-3837788
051135-31019217	051131-3256863	051131-37035131	051131-37147134, 136	051131-3837888
051135-31031217	051131-3256963	051131-37036131	051131-37148	..134, 135, 136	051131-3839988
051131-3140761	048011-34729138	051131-37037131	051131-37149	..134, 135, 136	051135-38441199
051131-3140861	048011-34730138	051131-37062124	051131-3744764	051135-38442199
051131-3143461	048011-34731138	051131-37063124	051131-3744864	051135-38443199
051131-3143561	048011-34732138	051131-37077121, 126	051135-37677198	051135-38444199
051131-3143761	048011-34733138	051131-37078121, 126	051131-3771287	051131-38883163
051131-3143861	048011-34734138	051131-37079121, 126	051131-3771687	3900069
051131-3143961	051131-3551963	051131-37080122	051131-3771788	051131-3900169
051131-3144061	051131-3554063	051131-37081122	051131-3771888	051131-3900269
051131-3144161	051131-3557663	051131-37082122	051131-3772012, 77, 88	051131-3900369
051131-3144261	051135-36592199	051131-37083122	051131-3772188	051131-3900470
051131-3144361	051135-36593199	051131-37100133	3805089	051131-3900670
051131-3150661	051135-36594199	051131-37101133	051131-3805189	051131-3900770
051131-3151261	051135-36595199	051131-37102133	3805289	051131-3900970
051131-3151961	051135-36596199	051131-37103133	051131-3807077, 87	051131-3901070
051131-3152061	051135-36597199	051131-37104133	051131-3807489	051131-3901170
051131-3152161	051135-36598199	051131-37105133	051131-3807589	051131-3901271

Index

By Part Number (continued)

Part Number	Page	Part Number	Page	Part Number	Page	Part Number	Page	Part Number	Page
051131-39013	71	051131-58709	101	051141-71603	231	051141-79903	230	051141-79977	230
051131-39016	77, 86	051131-59505	139	051141-71604	231	051141-79904	230	051141-79978	230
051131-39017	71	051131-59509	139	051141-71607	231	051141-79905	230	051141-79981	230
051131-39026	71	051131-59513	139	051141-720	224	051141-79906	230	051141-79982	230
051131-39034	72	051131-59517	139	051141-721	224	051141-79907	230	051141-79983	230
051131-39036	72	054007-60825	196	051141-722	224	051141-79908	230	051141-79984	230
051131-39040	72	021200-62013	110	051141-723	224	051141-79921	230	051141-79985	230
051131-39042	72	021200-62014	110	051141-724	224	051141-79922	230	051141-79986	230
051131-39066	72	051131-62030	124	051141-725	224	051141-79923	230	051141-79987	230
051131-39109	72	051131-62040	124	051141-726	224	051141-79924	230	051141-79988	230
051131-39526	72	051131-62041	124	051141-727	224	051141-79925	230	021200-82862	103
051131-39527	73	021200-62225	110	051141-728	224	051141-79926	230	021200-82863	103
051131-39529	73	051138-67533	217	051141-729	224	051141-79927	230	021200-82864	103
051131-39809	70	051138-67535	217	051141-730	224	051141-79928	230	021200-82865	103
051131-39819	72	051138-67537	217	051141-731	224	051141-79931	230	051141-83005	231
051131-39826	71	051138-67635	217	051141-732	224	051141-79932	230	051141-84701	220
051131-39834	72	051138-67636	217	051141-733	224	051141-79933	230	051141-84706	220
051131-39922	73	051138-67638	217	051141-734	224	051141-79934	230	051141-84802	220
051131-39924	73	051138-67639	217	051141-736	224	051141-79935	230	051141-84804	220
054007-41717	109	051138-67714	217	051141-737	224	051141-79936	230	051141-84806	220
054007-42033	195	051138-67715	217	051141-738	225	051141-79937	230	051141-84901	220
021200-45287	102	051138-67716	217	051141-740	225	051141-79938	230	051141-84904	220
051131-46334	96	051138-67764	217	051141-741	225	051141-79941	230	051141-84905	220
051131-46338	96	051138-67816	217	051141-746	226	051141-79942	230	051141-84906	220
051131-46545	97	051138-67823	217	051141-747	226	051141-79943	230	051141-84911	220
051131-46547	97	051138-67824	217	051141-748	227	051141-79944	230	051144-85078	77, 80, 84
021200-48140	103	051138-67825	217	051141-75906	227	051141-79945	230	051131-86741	100
054007-49517	197	051138-67826	217	051141-75951	227	051141-79946	230	051131-86962	140
054007-49518	197	051138-67827	217	051141-76051	227	051141-79947	230	021200-88228	103
054007-49519	197	051138-67828	217	051141-761	227	051141-79948	230	051131-91522	140
49656	109	051141-687	224	051141-762	228	051141-79961	230	051131-91536	140
021200-49828	101	051141-696	224	051141-763	228	051141-79962	230	051131-91537	140
021200-49829	101	051141-701	224	051141-764	229	051141-79963	230	PD100	91
021200-49830	101	051141-702	224	051141-769	229	051141-79964	230	PD101	91
021200-49831	101	051141-703	224	051141-770	229	051141-79965	230	PD102	91
021200-49832	101	051141-704	224	051141-771	224	051141-79966	230	PD103	91
021200-49833	101	054007-70488	195	051141-772	229	051141-79967	230	PD104	91
516-45	124	054007-70489	195	7721	92	051141-79968	230	PD105	91
021200-55181	103	051141-705	224	7723	92	051141-79971	230	PD106	91
051128-55385	109	051141-707	224	051141-773	229	051141-79972	230	PD107	91
051128-55386	109	051141-710	224	051141-774	224	051141-79973	230	PD108	91
054007-55916	199	051141-713	224	051141-775	224	051141-79974	230	PD109	91
054007-55918	199	051141-71601	231	051141-79901	230	051141-79975	230	PD110	91
054007-55919	199	051141-71602	231	051141-79902	230	051141-79976	230	PD111	91



All day! Every day!
Earn awards and rewards
for buying or selling
3M Automotive Products.

Aftermarket Rewards®

Focused towards professional installers, collision repair facilities, automotive and heavy truck maintenance and repair operations, Aftermarket Rewards® is a web based program that is password protected and offers points to the purchaser of 3M products. Points can be accrued with those from other member sponsoring vendors to earn premiums, awards and products for both personal and business use. Visit www.aftermarketrewards.com to see the amazing scope of potential rewards, to register and receive your user name and password. It's as simple as:

1. **Look** for bright yellow Reward Codes on Sponsors' products.
2. **Save** the Reward Codes from participating products.
3. **Enter** the Reward Codes online to earn points toward great rewards.



3M Top Driver Incentive Program



Targeting distributor and jobber inside sales and outside sales people, Top Driver is a web based incentive program where the sales person or their Company can earn points for selling specific 3M Automotive part numbered items. Points accrue in the registered sales person's account and may be redeemed for NASCAR™ wearable items, and premiums as well as other award premiums. Top Driver is easy to use, requires minimal redundant steps to record sales and builds point values and it can be competitive fun for sales representatives. Please visit <http://www.egroupnet.com/3m/aad/>

3M Branch Offices

Alaska 11151 Calaska Circle
Anchorage, Alaska 99515-2900
Telephone (907) 522-5200
Fax (907) 522-1645

Atlanta 2860 Bankers Industrial Drive
Atlanta, Georgia 30360-2764
Telephone 1-800-524-6429
Fax 1-800-699-7840

Chicago ... Four Westbrook Corporate Center
Suite 300
Westchester, Illinois 60154-5707
Telephone 1-800-524-5406
Fax 1-800-421-2483

Hawaii 4443 Malaai Street
Honolulu, Hawaii 96818-2136
Telephone (808) 422-2721
Fax (808) 422-9557

Los Angeles ... 10330 Pioneer Boulevard
Suite 280
Santa Fe Springs, California 90670-6012
Telephone 1-800-221-7569
Fax 1-800-648-0871

Puerto Rico 350 Chardon Avenue
Suite 1010
San Juan, Puerto Rico 00918
Telephone (787) 620-3000
Fax (787) 620-3012/3013

Material Safety Data Sheets

Fax On Demand (For five or less individual Material Safety Data Sheets)

1-800-305-0419 (in the U.S. and Canada) **651-732-6509** (outside North America)

For a complete set of Material Safety Data Sheets call:

1-877-MMM-CARS (1-877-666-2277)

For product information or additional questions call:

1-877-MMM-CARS (1-877-666-2277)

Internet

www.3M.com/automotive

Visit our website for more information concerning
3M's products and solutions to your repair problems.



Important Notice to Purchaser

Warranty and Limited Remedy: This product will be free from defects in material and workmanship at the time of shipment. **3M MAKES NO OTHER WARRANTIES, EXPRESS OR IMPLIED, INCLUDING, BUT NOT LIMITED TO, ANY IMPLIED WARRANTY OF MERCHANTABILITY OR FITNESS FOR A PARTICULAR PURPOSE.** User is responsible for determining whether the 3M product is fit for a particular purpose and suitable for user's application. If this product is defective, your exclusive remedy and 3M's and seller's sole obligation shall be, at 3M's option, to replace the product or refund the purchase price.

Limitation of Liability: 3M and seller will not be liable for any loss or damage arising from this 3M product, whether direct, indirect, special, incidental or consequential, regardless of the legal theory asserted, including warranty, contract, negligence or strict liability.



Automotive Aftermarket Division

3M Center, Building 223-6N-01
St. Paul, MN 55144-1000
U.S.A.

NASCAR™ is a trademark of the National
Association for Stock Car Auto Racing, Inc.

Printed in U.S.A.

Copyright © 2005, 3M IPC.
All rights reserved.
60-4400-9238-9
PN02499